

# TRAK<sup>®</sup> Knee Mill & ProtoTRAK<sup>®</sup> SM CNC Retrofit Safety, Programming, Operating & Care Manual

---

Document: P/N 23243 Version: 071204
--

Covers models:

- Retrofit
  - PTSM2
  - PTSM3
- TRAK Knee Mill with 2-Axis CNC
  - TRAK K2S
  - TRAK K3S
  - TRAK K4S
- TRAK Knee Mill with 3-Axis CNC
  - TRAK K2S-3
  - TRAK K3S-3
  - TRAK K4S-3



Southwestern Industries, Inc.

P. O. Box 9066

Compton, CA 90224-9066 USA

T | 310.608.4422 | F | 310. 764.2668

Service Department: 800.367.3165

e-mail: [sales@southwesternindustries.com](mailto:sales@southwesternindustries.com) | [service@southwesternindustries.com](mailto:service@southwesternindustries.com) | web: [southwesternindustries.com](http://southwesternindustries.com)

Copyright 2004, Southwestern Industries, Inc. All rights are reserved. No part of this publication may be reproduced, stored in a retrieval system, or transmitted, in any form or by any means, mechanical, photocopying, recording or otherwise, without the prior written permission of Southwestern Industries, Inc.

While every effort has been made to include all the information required for the purposes of this guide, Southwestern Industries, Inc. assumes no responsibility for inaccuracies or omission and accepts no liability for damages resulting from the use of the information contained in this guide.

All brand names and products are trademarks or registered trademarks of their respective holders.

Southwestern Industries, Inc.  
2615 Homestead Place  
Rancho Dominguez, CA 90220  
Phn 310/608-4422 ♦ Fax 310/764-2668  
Service Department  
Phn 800/367-3165 ♦ Fax 310/886-8029

# Table of Contents

<b>1.0</b>	<b>Introduction</b>		<b>6.0</b>	<b>DRO Mode</b>	
1.1	Models	1	6.1	Enter DRO Mode	25
1.2	Manual Organization	1	6.2	DRO Functions	25
<b>2.0</b>	<b>Safety</b>		6.3	Jog	26
2.1	Safety Publications	3	6.4	Power Feed	26
2.2	Danger, Warning, Caution and Note Labels and Notices Used in this Manual	3	6.5	Do One	27
2.3	Safety Precautions	6	6.6	Teach	27
			6.6.1	Entering Teach Data	27
<b>3.0</b>	<b>Description of the ProtoTRAK SM CNC</b>		6.7	Return to Absolute Zero	28
3.1	Display Pendant Front	9	6.8	Tool #	28
3.1.1	Keyboard Hard Keys	9	<b>7.0</b>	<b>Program Mode</b>	
3.1.2	Soft Keys	10		<b>Getting Started &amp; Some General Info</b>	
3.1.3	Emergency Stop Switch	10	7.1	Programming Overview	29
3.1.4	The Liquid Crystal Display	11	7.2	Enter Program Mode	29
3.2	Pendant Left Side	11	7.3	Program Header Screen	30
3.3	Pendant Right Side	12	7.3.1	Program Name	30
3.4	Optional Equipment	12	7.3.2	General Program Options	31
3.4.1	Position Encoders	12	7.3.3	Program Header Softkeys	32
3.4.2	Power Draw Bar	12	7.4	Auxiliary (AUX) Functions	32
3.4.3	Remote Stop Go Switch	12	7.5	Multiple Fixtures	33
3.4.4	Work Light	13	7.5.1	The Default Fixture	34
3.4.5	Coolant Pump	13	7.5.2	Fixtures & Running the Program	34
3.4.6	Auxiliary Functions	13	7.5.3	Editing Fixtures	34
3.4.7	Limit Switches	13	7.6	Assumed Inputs	34
3.5	Ballscrews	13	7.7	Z Rapid Positioning	34
3.6	Servo Motors	13	7.8	Softkeys within Events	35
3.7	Z Axis Glass Scales	13	7.9	Programming Events	35
3.8	Z Axis Ballscrew & Motor Assembly	13	7.10	Editing Data While Programming	36
			7.11	Look	37
<b>4.0</b>	<b>Basic Operation</b>		7.12	Finish Cuts	37
4.1	Switching the ProtoTRAK SM CNC on	15	7.13	Two Versus Three-Axis Programming	38
4.2	Shutting down the ProtoTRAK SM CNC	16	<b>8.0</b>	<b>Two-Axis Program Events</b>	
4.3	Emergency Stop	16	8.1	Posn Drill	39
4.4	Switching Between 2 & 3-Axis Operation	16	8.2	Bolt Hole Events	39
4.5	Help Functions	16	8.3	Mill Events	39
4.5.1	Math Helps	17	8.4	Arc Events	40
4.6	Windows Up or Down	18	8.5	Pocket Event	40
			8.5.1	Circular Pocket	41
<b>5.0</b>	<b>Definitions, Terms &amp; Concepts</b>		8.5.2	Rectangular Pocket	41
5.1	ProtoTRAK SM CNC Axis Conventions	19	8.5.3	Irregular Pocket	41
5.2	Part Geometry & Tool Path Programming	19	8.5.4	Tool Path in Pocket Events	42
5.3	Absolute & Incremental Reference	20	8.5.5	Conrad in Pocket Events	42
5.4	Referenced & Non-Referenced Data	20	8.6	Islands	42
5.5	Incremental Reference Position in Programming	20	8.6.1	Circular Island	42
5.6	Tool Diameter Compensation	21	8.6.2	Rectangular Island	43
5.7	Connective Events	21	8.6.3	Irregular Island	44
5.8	Conrad	22	8.7	Profile Events	44
5.9	Memory & Storage	22	8.7.1	Circle Profile	44
5.10	Planes & Vertical Planes	23	8.7.2	Rectangular Profile	45
5.11	Tool Diameter Compensation when Contouring in Z with Part Geometry	23	8.7.3	Irregular Profile	45
			8.8	Engrave Event	46
			8.9	Subroutine Events	47
			8.9.1	Repeat	48
			8.9.2	Mirror	48
			8.9.3	Rotate	49

8.10	Copy Events	49
8.11	Finishing Teach Events	50
<b>9.0</b>	<b>Three-Axis CNC Program Events</b>	
9.1	Posn: Position Events	51
9.2	Drill Events	51
9.3	Bolt Hole Events	52
9.4	Mill Events	52
9.5	Arc Events	53
9.6	Pocket Event	54
9.6.1	Circle Pocket	54
9.6.2	Rectangular Pocket	54
9.6.3	Irregular Pocket	55
9.6.4	Tool Path in Pocket Events	56
9.6.5	Zigzag Z Depth Cuts	56
9.6.6	Conrad in Pocket Events	56
9.6.7	Bottom Finish Cut	57
9.7	Islands	57
9.7.1	Circular Island	57
9.7.2	Rectangular Island	58
9.7.3	Irregular Island	59
9.8	Profile Events	60
9.8.1	Circle Profile	60
9.8.2	Rectangular Profile	60
9.8.3	Irregular Profile	61
9.9	Helix Events	62
9.10	Subroutine Events	62
9.10.1	Repeat	64
9.10.2	Mirror	64
9.10.3	Rotate	64
9.11	Copy Events	65
9.12	Thread Mill Event	65
9.13	Pause Events	65
9.14	Engrave Event	66
9.15	Finishing Teach Events	68
<b>10.0</b>	<b>Auto Geometry Engine (A.G.E.) Programming</b>	
10.1	Starting the A.G.E.	69
10.2	A.G.E. Mill Prompts	70
10.3	A.G.E. Arc Prompts	71
10.4	Skipping Over Prompts	71
10.5	The OK/NOT OK Flag	71
10.6	Ending A.G.E.	72
10.7	Guessing Data	72
10.8	Look & Guess	73
10.9	Calculated Data	74
10.10	Arcs and Conrads	74
10.11	Tangency	74
<b>11.0</b>	<b>Edit Mode</b>	
11.1	Delete Events	77
11.2	Spreadsheet Editing™	77
11.2.1	Selecting Data to be Displayed on the Search Edit Table	78
11.2.2	Sorting Data	79
11.2.3	Making Global Changes to Data	79
11.3	Erase Program	81
11.4	Clipboard	81

<b>12.0</b>	<b>Set Up Mode</b>	
12.1	The Tool Table	83
12.1.1	The Tool Table Screen	84
12.1.2	Simple Tool Set-Up for Two-Axis CNC Machining	84
12.1.3	The Logic of the Tool Table	84
12.1.4	Initial Tool Set-Up	85
12.1.5	Starting Over: Erasing Tool Info	86
12.1.6	Adding a Tool	86
12.1.7	Replacing a Tool	86
12.1.8	Z Modifiers	87
12.1.9	Resetting the Reference Point	87
12.1.10	Saving Tool Information	87
12.1.11	Opening a Program	87
12.1.12	Making Tool Set-Ups Easy	88
12.1.13	Tool Table & 2-Axis CNC Operation	88
12.2	Tool Path	88
12.2.1	Soft Keys in Tool Path	89
12.3	Reference Positions (REF POSN)	89
12.3.1	Z Retract	90
12.3.2	Home Positions	90
12.3.3	Limit Positions	90
12.4	Fixture Offsets	90
12.5	Service Codes	91
<b>13.0</b>	<b>Run Mode</b>	
13.1	Run Mode Screen	93
13.2	Two Versus Three-Axis Running	93
13.3	Starting to Run	94
13.4	Program Run	94
13.5	Program Run Messages	95
13.6	Stop	95
13.7	Feedrate Override	95
13.8	Trial Run	95
13.9	Data Errors	96
13.10	Fault Messages	96
<b>14.0</b>	<b>Program In/Out Mode</b>	
14.1	Softkey Selections in the Program In/Out Mode	98
14.2	Basic Navigation of Program In/Out Mode Screens	98
14.2.1	Basic Parts of the Program In/Out Mode Screens	98
14.2.2	Softkeys in the Program In/Out Mode Screens	99
14.3	Opening a File	99
14.4	Saving Programs	99
14.5	Copying Programs	100
14.6	Deleting Programs	101
14.7	Renaming	102
14.8	Backing Up	103
14.9	Converters™	104
14.9.1	Activating Converters	104
14.9.2	Converting from a Different Format Into a ProtoTRAK SM CNC	105
14.9.3	Converting from the ProtoTRAK CNC to a Different Format	106
14.10	ProtoTRAK and TRAK CNC Compatibility	106
14.10.1	File Formats	107
14.10.2	Opening .MX2 & .MX3 Files	107
14.10.3	Running ProtoTRAK SM Files on ProtoTRAK & TRAK CNC	108

14.11	Running G Code Files	109
14.11.1	G Codes Recognized by the ProtoTRAK SM CNC	109
14.11.2	M Codes Supported by the ProtoTRAK SM CNC	109
14.11.3	Valid Characters for Word/Address Sequences	110
14.12	Networking	110
14.12.1	What is a Network?	110
14.12.2	Why would you want to use the networking capability of the ProtoTRAK SM CNC control?	110
14.12.3	A Word of Advice Before Setting Up Your Network	111
14.12.4	Peer-to-Peer Network	111
14.12.5	Basic Network Set-Up	112
14.12.6	Server & Client Network Overflow	116
14.12.7	Network Description of the ProtoTRAK	118
14.13	RS232 Interface	119
14.13.1	Connections	119
14.13.2	Receiving a File	119
14.13.3	Sending a File	119
14.14	CAD/CAM & Post Processors	121
14.14.1	Writing a Post Processor	122
14.14.2	Convertible G-Codes	123
14.14.3	Supported Addresses	123
14.14.4	Format Terms & Definitions	124
14.14.5	G Codes that Generate Errors	125
14.14.6	Accepted M Codes	126
<b>15.0</b>	<b>Sample Programs</b>	
15.1	Sample Program No. 1	127
15.2	Sample Program No. 2	132
<b>16.0</b>	<b>Description of TRAK K Mills</b>	
16.1	TRAK K Mill Models	135
16.2	Machine Overview	135
16.3	Machine Dimensions	136
16.4	Machine Specifications	137
16.5	Maximum Machining Capacities	137
16.6	Machine Options	137
16.7	Lubrication	137
16.7.1	Manual Lubrication	137
16.7.2	Head Lubrication	138
<b>17.0</b>	<b>Machine Operation</b>	
17.1	Spindle On/Off, Forward/Reverse	139
17.2	Table, Saddle, Knee/Clamps	140
17.3	Raising/Lowering the Knee	140
17.4	Spindle Brake	140
17.5	Draw Bar	140
17.6	Changing Speeds: High-Low-Neutral	140
17.7	Changing Speeds: Variable Speed	141
17.8	Operating the Quill	141
17.9	Adjusting the Quill Stop	141
17.10	Quill Feed	141
17.10.1	Power Feed Engagement Lever	141
17.10.2	Fine Feed Direction Shaft	142
17.10.3	Quill Feed Selector	142

17.10.4	Feed Trip Lever	143
17.10.5	Fine Hand Quill Feed	143
17.10.6	Fine Automatic Quill Feed	143

### ProtoTRAK SM Training Checklist

# 1.0 Introduction

Congratulations! Whether you bought the ProtoTRAK SM CNC as a retrofit or as the CNC integrated into the TRAK Knee Mill, you have an excellent toolroom machine. The ProtoTRAK SM has an easy-to-use interface and dozens of features that maximize your productivity for any toolroom job.

**Manual machining** is always available and made easier with features like power feed, 100 inch per minute rapids, tool offsets and all the best features of sophisticated DRO's.

**Two-axis machining** is available at the touch of a button for the prototyping and moderately complex, low volume work that is typically done on knee mills.

**Three-axis CNC machining** is also available for retrofit and with the TRAK Knee Mills. Programs may be entered at the control or imported from CAD/CAM files.

The operation of the ProtoTRAK SM CNC has been painstakingly refined to bring you the best in technology while retaining the ease of use that has made ProtoTRAK the top brand in controls for low volume production.

## 1.1 Models

The ProtoTRAK SM CNC is featured as a two or three-axis CNC in the following products:

### Retrofits

Model	Description
PTSM2	Two-axis CNC retrofit to your knee mill
PTSM3	Three-axis CNC retrofit to your knee mill

### Knee Mills

TRAK-K2S	Two-axis CNC, 33" x 12", 3HP
TRAK-K3S	Two-axis CNC, 32" x 16", 3 HP
TRAK-K4S	Two-axis CNC, 32" x 16 1/2", 5 HP
TRAK-K2S-2	Three-axis CNC, 33" x 12", 3 HP
TRAK-K3S-3	Three-axis CNC, 32" x 16", 3 HP
TRAK-K4S-3	Three-axis CNC, 32" x 16 1/2", 5 HP

## 1.2 Manual Organization

This manual covers the operation of all retrofit and TRAK K Mill products that use the ProtoTRAK SM CNC.

Some Sections do not apply to all users. For example, if you own a ProtoTRAK SM 2-axis retrofit, you should skip:

- Section 9, Three-axis program events
- Section 16 and 17, description and operation of TRAK K Mills.

Sections that may not apply to all users contain a note to inform you of this fact.

**Section 2** of this manual provides important safety information. It is highly recommended that all operators of this product review this safety information.

**Section 3** provides a description of the ProtoTRAK SM CNC.

**Section 4** describes the operation of the milling machine and some basic operations of the ProtoTRAK SM CNC.

**Section 5** defines some terms and concepts useful in learning to program and operate the ProtoTRAK SM CNC.

The ProtoTRAK SM CNC is organized into six Modes of operation that are described in the following sections.

**Section 6** DRO: Digital Readout, jog, and powerfeed operations.

**Section 7** Program Mode, Getting Started: covers some general programming information and instructions on starting new programs.

**Section 8** Two-Axis Program Events: instructions for the canned cycles, or events used to program the ProtoTRAK SM as a two-axis CNC.

**Section 9** Three-Axis CNC Program Events: instructions for programming in three-axis CNC.

**Section 10** Auto Geometry Engine Programming: instructions for programming profiles and pockets using the powerful Auto Geometry Engine.

**Section 11** Edit Mode: for routines to make large-scale changes to programs in current memory, including the powerful Spreadsheet Editing®.

**Section 12** Set-Up Mode: Tool information, part graphics and special codes.

**Section 13** Run Mode: Instructions on running a program to machine your part.

**Section 14** Program In/Out Mode: Storing and managing your programs.

**Section 15** Sample Programs: Contains two sample programs to help you get started.

**Section 16** provides a description of each model of TRAK K Mill.

**Section 17** describes the operation of the TRAK K Mill.

## 2.0 Safety

The safe operation of your knee mill depends on its proper use and the precautions taken by each operator.

- Read and study this manual. Be certain every operator understands the operation and safety requirements of this machine *before* its use.
- Always wear safety glasses and safety shoes.
- Always stop the spindle and check to ensure the CNC control is in the stop mode before changing or adjusting the tool or workpiece.
- Never wear gloves, rings, watches, long sleeves, neckties, jewelry, or other loose items when operating or around the machine.
- Use adequate point of operation safeguarding. It is the responsibility of the employer to provide and ensure point of operation safeguarding per OSHA 1910.212 - Milling Machine.

### 2.1 Safety Publications

Refer to and study the following publications for assistance in enhancing the safe use of this machine.

**Safety Requirements For The Construction, Care And Use of Drilling, Milling, and Boring Machines** (ANSI B11.8-1983). Available from The American National Standards Institute, 1430 Broadway, New York, New York 10018.

**Concepts And Techniques Of Machine Safeguarding** (OSHA Publication Number 3067). Available from The Publication Office - O.S.H.A., U.S. Department of Labor, 200 Constitution Avenue, NW, Washington, DC 20210.

### 2.2 Danger, Warning, Caution, and Note Labels and Notices As Used In This Manual

**DANGER** - Immediate hazards that **will** result in severe personal injury or death. Danger labels on the machine are red in color.

**WARNING** - Hazards or unsafe practices that *could* result in severe personal injury and/or damage to the equipment. Warning labels on the machine are orange in color.

**CAUTION** - Hazards or unsafe practices that *could* result in minor personal injury or equipment/product damage. Caution labels on the machine are yellow in color.

**NOTE** - Call attention to specific issues requiring special attention or understanding.





<b>SOUTH WESTERN INDUSTRIES</b> 2615 HOMESTEAD PLACE, RANCHO DOMINGUEZ, CA 90220			
MODEL	TRAK K3		
S/N			
ELECTRICAL RATINGS:			
220	VOLTS	8.5	AMPS
3	PHASE		
60	Hz		
FLA OF LARGEST MOTOR		8.5	AMPS
SHORT CIRCUIT INTERRUPT		200K	AMPS
ELECTRICAL DRAWING #:		20598-1	
CNC CONTROL ELECTRICAL RATINGS: IF APPLICABLE			
115	VOLTS	8	AMPS
1	PHASE		
60	Hz		
MACHINE (ONLY) MADE IN "XXXXXX"			

i00902

## Safety & Information Labels Used On The TRAK Knee Mills\*

*It is forbidden by OSHA regulations and by law to deface, destroy or remove any of these labels*

\*Retrofit customers: please see the manual that came with your machine for information about safety and information labels.



# HIGH VOLTAGE

## 230 VOLTS

### WARNING

IMPROPER INSTALLATION OR OPERATION OF THIS MOTOR MAY CAUSE INJURY TO PERSONNEL OR MOTOR FAILURE. READ OPERATING INSTRUCTIONS.

MOTOR MUST BE INSTALLED AND GROUNDED PER LOCAL AND NATIONAL ELECTRICAL CODES.

TO REDUCE POTENTIAL OF ELECTRICAL SHOCK DISCONNECT ALL POWER SOURCES BEFORE INITIATING ANY MAINTENANCE OR REPAIRS.

KEEP FINGERS AND FOREIGN OBJECTS AWAY FROM VENTILATION AND OTHER OPENINGS. KEEP AIR PASSAGES CLEAR.

EYEBOLTS OR LIFTING HOOKS, WHEN SUPPLIED, ARE INTENDED FOR LIFTING THE PRODUCT ONLY AND MUST NOT BE USED TO LIFT ADDITIONAL WEIGHT.

USE ONLY GRADE 5 SHOULDER EYEBOLTS WITH MINIMUM THREAD LENGTH OF 1 1/2 TIMES DIAMETER.

## Safety & Information Labels Used On The ProtoTRAK SM CNC

*It is forbidden by OSHA regulations and by law to deface, destroy or remove any of these labels*

## 2.3 Safety Precautions

1. Do not operate this machine before the **ProtoTRAK SM CNC Safety, Installation, Maintenance, Service and Parts List Manual**, and the this **Safety, Programming, Operating & Care Manual** have been studied and understood.
2. Do not run this machine without knowing the function of every control key, button, knob, or handle. Ask your supervisor or a qualified instructor for help when needed.
3. Protect your eyes. Wear approved safety glasses (with side shields) at all times.
4. Don't get caught in moving parts. Before operating this machine remove all jewelry including watches and rings, neckties, and any loose-fitting clothing.
5. Keep your hair away from moving parts. Wear adequate safety headgear.
6. Protect your feet. Wear safety shoes with oil-resistant, anti-skid soles, and steel toes.
7. Take off gloves before you start the machine. Gloves are easily caught in moving parts.
8. Remove all tools (wrenches, check keys, etc.) from the machine before you start. Loose items can become dangerous flying projectiles.
9. Never operate a milling machine after consuming alcoholic beverages, or taking strong medication, or while using non-prescription drugs.
10. Protect your hands. Stop the machine spindle and ensure that the CNC control is in the stop mode:
  - Before changing tools
  - Before changing parts
  - Before you clear away the chips, oil or coolant. Always use a chip scraper or brush
  - Before you make an adjustment to the part, fixture, coolant nozzle or take measurements
  - Before you open safeguards (protective shields, etc.). Never reach for the part, tool, or fixture around a safeguard.
11. Protect your eyes and the machine as well. Don't use a compressed air hose to remove the chips or clean the machine (oil, coolant, etc.).
12. Stop and disconnect the machine before you change belts, pulley, gears.
13. Keep work area well lighted. Ask for additional light if needed.

14. Do not lean on the machine while it is running.
15. Prevent slippage. Keep the work area dry and clean. Remove the chips, oil, coolant and obstacles of any kind around the machine.
16. Avoid getting pinched in places where the table, saddle or spindle head create "pinch points" while in motion.
17. Securely clamp and properly locate the workpiece in the vise, on the table, or in the fixture. Use stop blocks to prevent objects from flying loose. Use proper holding clamping attachments and position them clear of the tool path.
18. Use correct cutting parameters (speed, feed, depth, and width of cut) in order to prevent tool breakage.
19. Use proper cutting tools for the job. Pay attention to the rotation of the spindle: Left hand tool for counterclockwise rotation of spindle, and right hand tool for clockwise rotation of spindle.
20. Prevent damage to the workpiece or the cutting tool. Never start the machine (including the rotation of the spindle) if the tool is in contact with the part.
21. Check the direction (+ or -) of movement of the table when using the jog or power feed.
22. Don't use dull or damaged cutting tools. They break easily and become airborne. Inspect the sharpness of the edges, and the integrity of cutting tools and their holders. Use proper length for the tool.
23. Large overhang on cutting tools when not required result in accidents and damaged parts.
24. Prevent fires. When machining certain materials (magnesium, etc.) the chips and dust are highly flammable. Obtain special instruction from your supervisor before machining these materials.
25. Prevent fires. Keep flammable materials and fluids away from the machine and hot, flying chips.
26. When working in manual mode (not CNC) make sure the computer control is switched to DRO or OFF.



## 3.0 Description of the ProtoTRAK SM CNC

The ProtoTRAK SM CNC is available as either a two-axis CNC, or as a three-axis CNC (both with three axis DRO). For work typically done on knee mills, the two-axis CNC is usually preferred because of its simplicity and ease of use.

### 3.1 Display Pendant Front (see Figure 3.1)

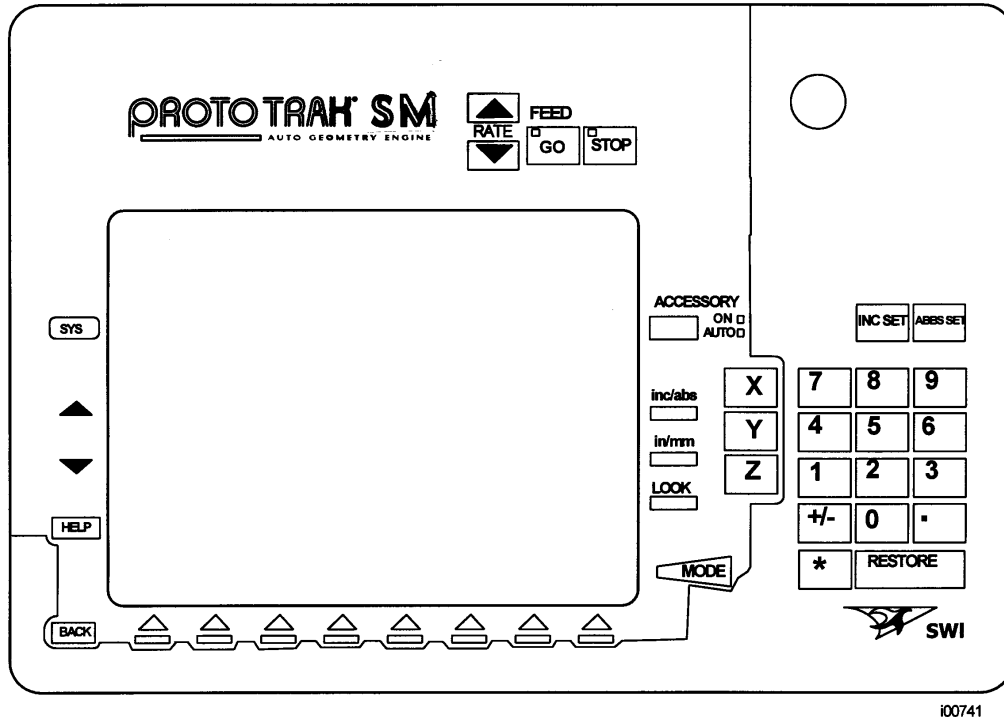

FIGURE 3.1 The ProtoTRAK SM CNC front panel

#### 3.1.1 Keyboard Hard Keys

- **Feed Keys**

**GO:** initiates motion in Run. The green LED on the GO key will be lit when the servomotors are moving the machine either in jog or when the program run has been initiated by the GO key.

**STOP:** halts motion during Run. The red LED on the STOP key will be lit when the servos motors are not moving the machine.

**FEED ↑:** feedrate override to increase feedrate up to 150%.

**FEED ↓:** feedrate override to decrease feedrate down to 10%.

**ACCESSORY:** This key is used only for controlling a coolant pump or mister through the optional auxiliary functions box. If you do not have the optional Auxiliary functions (available for the three-axis CNC only) this key is not used. When the switch is in the On position, the coolant pump (or mister) will come on and stay on during machining operations. In the Auto mode, the coolant pump or mister will be

controlled as programmed by the Auxiliary functions. To get to the Auto operation, press and hold the Accessory key. If neither light is on, the coolant pump or mister will not operate.

**INC SET:** loads incremental dimensions and general data

**ABS SET:** loads absolute dimensions and general data

**INC/ABS:** switches all or one axis from incremental to absolute or absolute to incremental

**IN/MM:** causes Inch to Metric or Metric to Inch conversion of displayed data

**LOOK:** part graphics in Program mode

**X, Y, Z:** selects axis for subsequent commands

**RESTORE:** clears an entry, aborts a keying procedure

**0-9, +/-, . :** inputs numeric data with floating point format. Data is automatically + unless +/- key is pressed. All input data is automatically rounded to the system's resolution.

**MODE:** to change from one mode of operation to another

**SYS:** To shut down the ProtoTRAK SM CNC and (if the 3-axis CNC is operable) to change from 2-axis to 3-axis, or 3-axis to 2-axis operation. Access to Windows functions for network configuration is also available via this key.

▲ : reinstates a window.

▼ : eliminates a window.

**HELP:** displays help information, math help or additional functions. Active for additional functions when the help symbol (a blue question mark) is displayed on the screen next to the HELP key.

### 3.1.2 Soft Keys

Beneath the display are 8 keys that are labeled with arrows. These keys are called software programmable or soft keys. A description of the function or use of each of these keys will be shown at the bottom of the display directly above each key. If, at any time, there is no description above a key, that key will not operate.

Sometimes the description or function of the key is visible but grayed out. This indicates that the particular function is not available because of some other condition. For example, if the Z retract is not set, the RUN mode key will be grayed out because setting the Z retract is a necessary step for running a program.

### 3.1.3 Emergency Stop Switch

The emergency stop (E-stop) switch kills all power to the spindle and ProtoTRAK's servomotors. The computer and pendant remain powered.

### 3.1.4 The Liquid Crystal Display (LCD)

The display of the ProtoTRAK SM CNC is a 10.4" active-matrix color LCD. The very top is the Status Line that shows the overall status of the ProtoTRAK SM CNC. This includes the current Mode, the current program part number, the current tool number, 2 or 3-axis mode and whether the X, Y and Z dimensions are in inch or millimeter (mm).

Just above the soft keys is a data input line that appears when an input is required.

### 3.2 Pendant Left Side *(See Figure 3.2 for a description of the left side panel of the display.)*

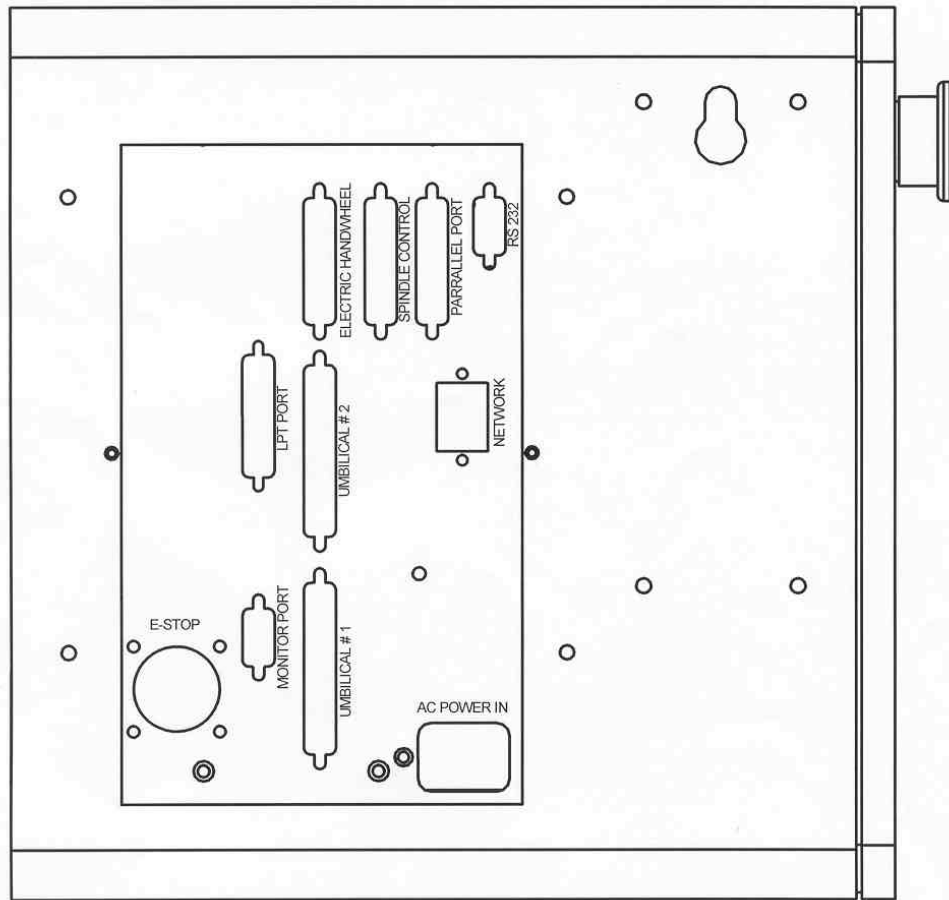

100871

**FIGURE 3.2** *The ProtoTRAK SM CNC left side with connectors labeled*



**3.3 Pendant Right Side** (See Figure 3.3 for a description of the connectors and features located on the right side of the display panel.)

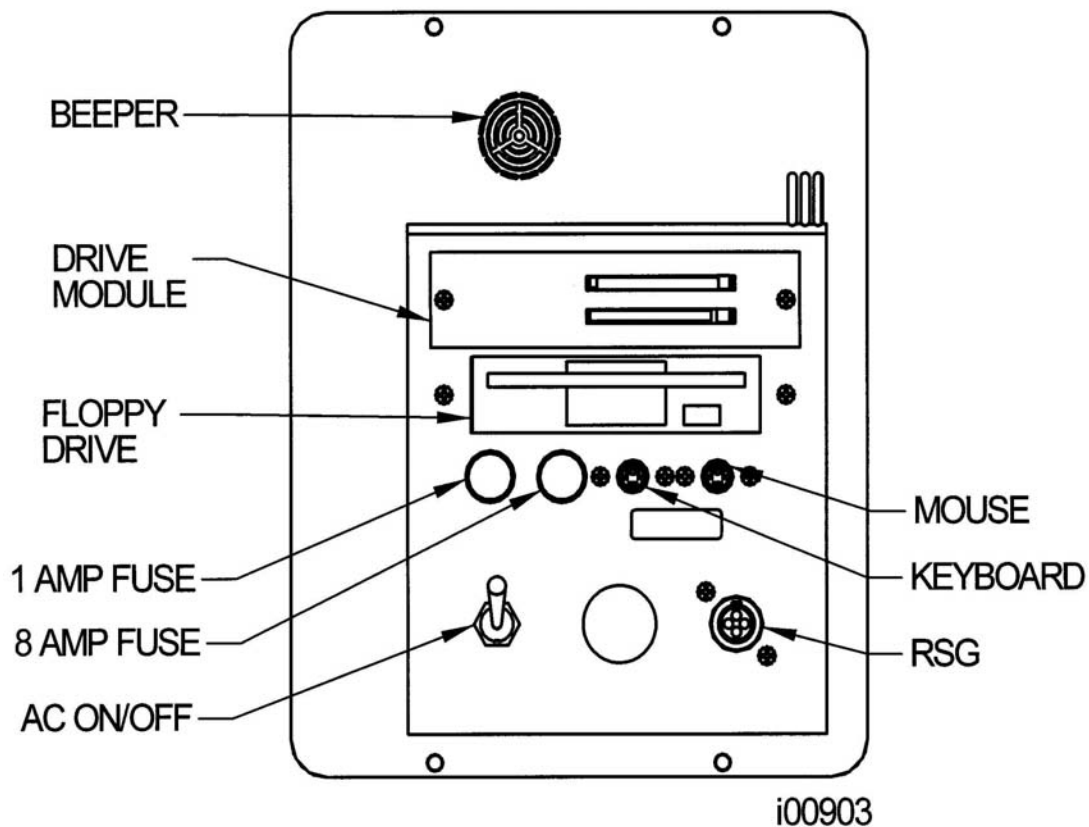

*FIGURE 3.3 The ProtoTRAK SM CNC right side*

**3.4 Optional Equipment**

**3.4.1 Position Encoders**

The ProtoTRAK SM CNC may be configured to run either with or without independent position encoders for X and Y travel. Optional encoders include the TRAK sensors or glass scales, each with .0002" underlying resolution.

**3.4.2 Power Draw Bar**

A manual draw bar, of the NMTB or NST type comes standard with the machine. A power draw bar option may be ordered. The draw bar included in the option may be CAT or NMTB/NST.

An NMTB/NST type of draw bar is the appropriate length to fit tool holders that have a threaded tang on the top. The CAT type is longer to thread into CNC tool holders that have the tool changer grip, or retention knob removed.

### 3.4.3 Remote Stop Go Switch

For the convenience of operation while running the program, a Remote Stop/Go switch may be purchased. This switch is on a ten-foot cable and operates like the FEED Stop and Go keys on the display.

### 3.4.4 Work Light

An optional halogen work light is available. It mounts to the left side (facing) of the column and plugs into a 110v outlet in the electrical cabinet.

### 3.4.5 Coolant Pump

The optional coolant pump is mounted in the back of the machine column. When used with a 3-axis CNC and auxiliary functions, it is plugged into the electrical cabinet to operate as commanded by the auxiliary functions. For use with a two-axis CNC, a manual switch is provided.

### 3.4.6 Auxiliary Functions (available for use with the 3-axis CNC)

Auxiliary functions are controlled through the ProtoTRAK SM CNC either in the program or with the accessory key on the front panel. The Auxiliary functions consist of the following:

- Spindle off command. (Note: This function is not available for retrofits.)
- An air solenoid to control spray misters or other pneumatically activated peripheral equipment. Shop air should not exceed 125 psia.
- Switched and fused 120 VAC 8 Amp outlet(s) for coolant pumps, automatic oilers, etc.
- INPUT/OUTPUT to interface with programmable indexers, dividing heads, etc.
  - Output from ProtoTRAK SM CNC 3 is .3-second actuation of a solid-state relay between pin 3 (plus), and pin 4 (minus).
  - Input to the ProtoTRAK SM CNC is .3-second actuation of a solid-state relay between pin 1 (plus), and pin 2 (minus).
  - Note: Pin 1 is on top, 2 on right, 3 on left, 4 on bottom.

### 3.4.7 Limit Switches

There are limit switches for the ram, saddle and table travel.

## 3.5 Ballscrews

Precision, ground ballscrews are installed in the table and saddle for smooth, positive control without backlash.

## 3.6 Servo Motors

The servo motors on table, saddle and ram are 280 in-oz torque. Integrated into each motor is an encoder with 0.000018" underlying resolution.

## 3.7 Z Axis Glass Scale

For two-axis CNC models, a glass scale is installed on the quill.

### **3.8 Z Axis Ballscrew and Motor Assembly**

For three-axis CNC operation, a ballscrew and motor assembly is attached to the front of the machine head using the four tramping bolts. The ballscrew is attached to the quill through the threaded hole for the quill stop knob. Quill motion is measured using an encoder on the ballscrew.

## 4.0 Basic Operation

One of the things that makes the ProtoTRAK SM CNC so easy to use is that most of the operations are organized in Modes. Modes are logical groups of activities that naturally belong together. This eliminates the need to memorize operations – just select a mode and choose among the soft keys.

Most operations will be discussed within the section that treats the mode later in this manual. The operations described in this section either don't fit in a particular mode, or they are relevant to more than one mode.

### 4.1 Switching the ProtoTRAK SM CNC On

To turn the ProtoTRAK SM CNC on, move the toggle switch on the display side panel to the Up position.

The Windows operating system and the ProtoTRAK SM CNC software will take a few seconds to load from the system's flash memory. If you have connected the ProtoTRAK SM CNC to a network, it may take as long as 90 seconds for the communications to be established. When complete, the ProtoTRAK SM CNC Select Mode screen will appear.

Select the Mode of operation by pressing the soft key beneath the labeled box. Notice that the EDIT and RUN soft keys are grayed out when the system is first turned on. They will not function because there is no program in the ProtoTRAK SM CNC. Once a program is entered, the EDIT key will function. Once a program is entered and the necessary SET-UP operations are complete, the RUN key will function.

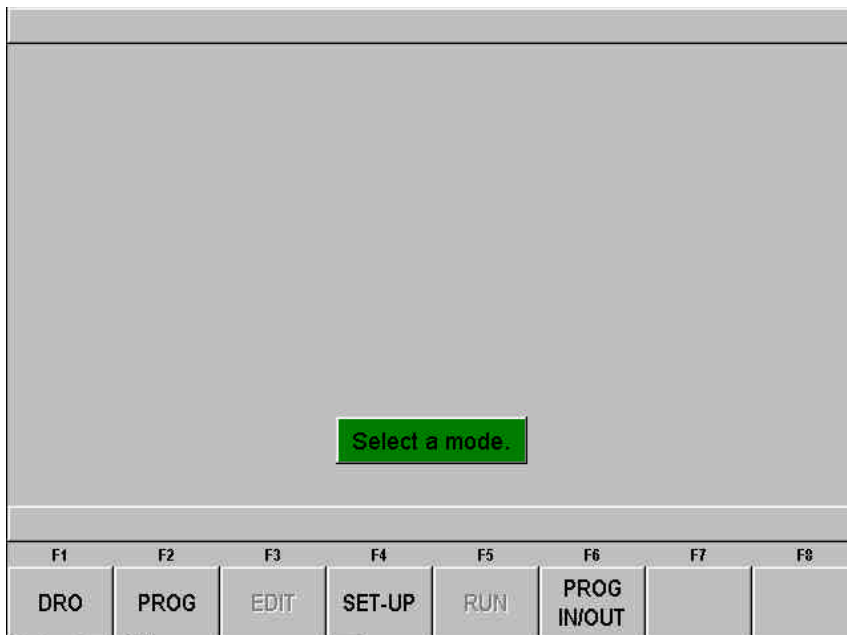

**FIGURE 4.1.1** The main “select a mode” screen. Shown here, the Edit and Run Modes are grayed out because there is no program in current memory

The ProtoTRAK SM CNC has a screen saver already programmed in. If the system is not used (either by a key stroke or by counting) for 20 continuous minutes, the display will turn itself off. The LED's on the keypad will flash every few seconds to indicate that the system is still on.

Press any key or move any axis to bring the screen back to its previous display. The key you press will be ignored except to turn the screen on.

#### 4.2 Shutting down the ProtoTRAK SM CNC

**Important:** the system must be turned off properly. First press the SYS hard key and then press the SHUT DOWN soft key (see Figure 4.4). After a few seconds, you will see the message "it is now safe to turn off your computer". Turn the ProtoTRAK SM CNC off by moving the toggle switch on the display side panel to the down position.

If the CNC is not shut down properly, the system will make you wait while it runs a scan disk self-diagnostic routine and scold you for not following the instructions.

*Note: When you turn the PROTOTRAK SM CNC off, always wait a few seconds before turning it back on.*

#### 4.3 Emergency Stop

Press the button to shut off power to the spindle motor and axis motors. Rotate the switch to release.

#### 4.4 Switching Between Two and Three-axis Operation

When purchased as a three-axis CNC, the ProtoTRAK SM CNC may be operated as a two axis CNC as well. Press the SYS hard key. Softkey F2 will read GO TO 2 AXIS when the ProtoTRAK SM CNC is currently operating in three axis and it will say GO TO 3 AXIS when the ProtoTRAK SM CNC is currently operating in two axis. See Figure 4.4.

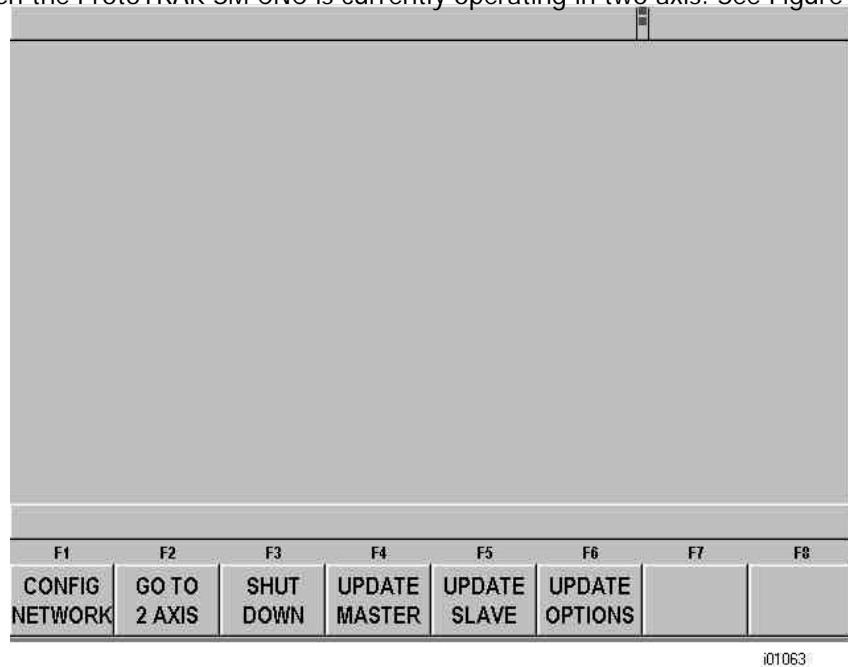

**FIGURE 4.4** You will see this screen when the SYS hard key is pressed. The choice

“GO TO 2 AXIS” shows that the CNC is currently in 3-Axis operation.

#### 4.5 Help Functions

When a blue question mark appears next to the HELP hard key, that means special functions or configuration settings are available for the current operation. For example, at the program header with the highlight on the program name, the blue question mark appears. Pressing the HELP key at that time will call up a table with alpha and special characters you can use to name your program.

#### 4.5.1 Math Helps

When the blue question mark does not appear, pressing HELP will initiate the Math Helps.

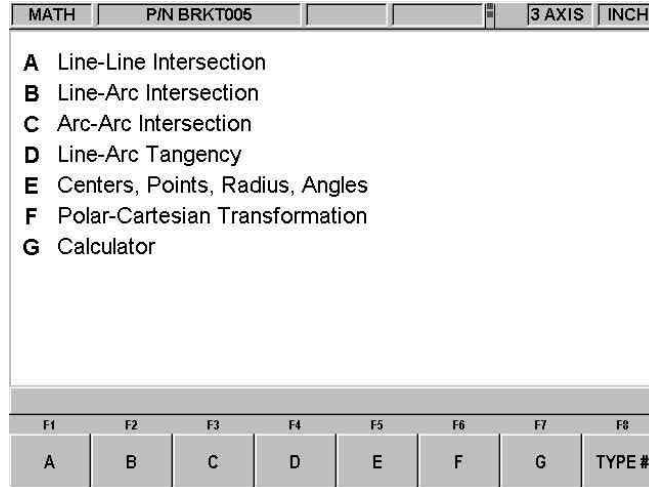

**FIGURE 4.5.1** The first Math Helps screen. Choose among the alternatives based on the information you need to calculate

Math Helps are powerful routines that enable you to use the data you have available to calculate missing print data.

For example, Math Help type 28 enables you to solve an entire right triangle by giving two known pieces of data. To exit from the Math Help, press the Mode key.

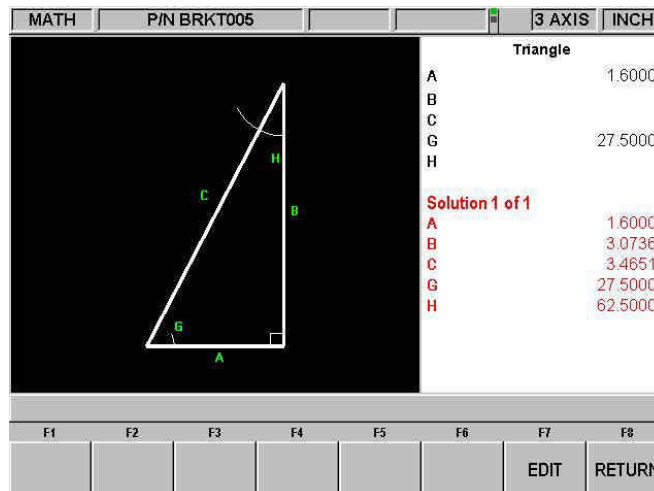

**FIGURE 4.5.2** *Math Help 28. In this example, by entering the length of line A and the value of angle G, the other values are calculated*

You may have the Math Help solutions load directly into your program. This saves you from having to write down the solution and then key it in. While you are programming the event that needs the data from Math Help, simply press the HELP key to start the Math Help. Once a solution is obtained, you will have the following soft key selections:

**Load Begin:** will load the displayed solution into the event as the X and Z beginning.

**Load End:** will load the displayed solution into the event as the X and Z end.

**Load Center:** will load the displayed solution into the event as the X and Z center.

**Next Solution:** when there is more than one solution to the problem, this will display the alternative solutions.

**Edit:** this allows you to go back to the data you entered in order to make changes. Once you do this, the Resolve key will appear.

**Resolve:** press this to have the Math Help use the new data to give new solutions.

## 4.6 Windows Up or Down

Some of the selections in the ProtoTRAK SM CNC will cause a window to appear with a message. To eliminate the window in order to see what is behind it, press the ▼ hard key. To restore the window, press the ▲ hard key.

## 5.0 Definitions, Terms & Concepts

### 5.1 ProtoTRAK SM CNC Axis Conventions

**X Axis:** positive X-axis motion is defined as the table moving to the left when facing the mill. Consequently, measurement to the right is positive on the workpiece.

**Y Axis:** positive Y-axis motion is defined as the table moving toward you. Measurement toward the machine (away from you) is positive on the workpiece.

**Z Axis:** positive Z-axis motion is defined as moving the head up. Measurement up is also positive on the workpiece.

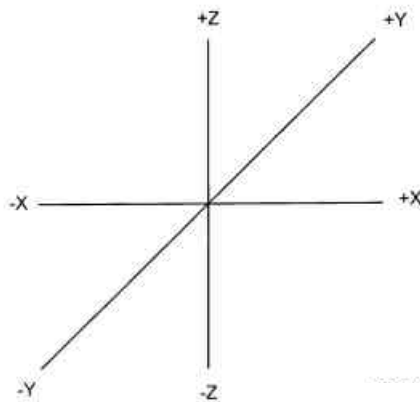

*FIGURE 5.1 ProtoTRAK SM CNC conventions*

The Z RAPID dimension is the position at which Z will stop rapid traversing and switch to its programmed Z feedrate. Z motion will continue until Z End depth has been reached.

### 5.2 Part Geometry & Tool Path Programming

The ProtoTRAK SM CNC gives you ultimate flexibility in programming. Programs that are entered through the ProtoTRAK SM CNC system can be entered as either Part Geometry or Tool Path.

Part Geometry programming is the popular programming style of the ProtoTRAK family of products. This is done by defining the final geometry of the part, and the ProtoTRAK SM CNC has the job of figuring out the tool path from the part dimensions and the tool set-up information. This is a great benefit compared to regular CNC because it doesn't force the programmer to do the difficult job of defining tool path. A consequence of part geometry programming is that the following are not allowed:

- connection of an incline plane and another event
- connection of two events that lie in different vertical planes

Using Geometry Programming, it is impossible for the ProtoTRAK SM CNC to calculate a tool path for these cases without creating a problem: in cutting the geometry desired in the first event, the tool ends up out of position for the next event. Resolving the difference in tool position where the first event ends and the next event begins means either the CNC calculates and makes an unprogrammed move, or it retracts the tool out and then back into the part.



These cases are not encountered often, but when they are you have the option of using Tool Path programming. In Tool Path programming you define the events the same way, but all inputs are treated as tool center. It is your job to calculate and program the tool path.

### 5.3 Absolute & Incremental Reference

The ProtoTRAK SM CNC may be programmed and operated in either (or in a combination) of absolute or incremental dimensions. An absolute reference from which all absolute dimensions are measured (in DRO and program operation) can be set at any point on or even off the workpiece.

To help understand the difference between absolute and incremental position, consider the following example:

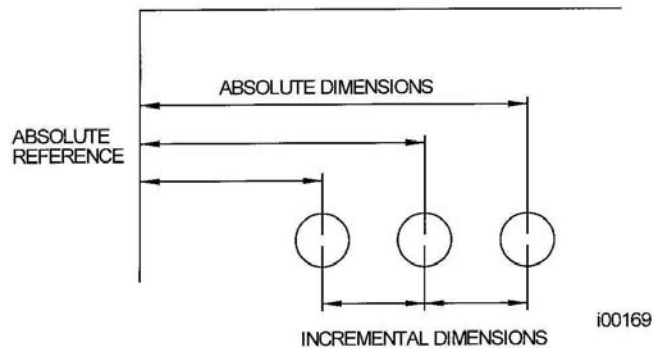

**FIGURE 5.3** Each point has both an absolute and an incremental reference in the X axis. The ProtoTRAK SM CNC allows you to program using either.

### 5.4 Referenced & Non-Referenced Data

Data is always loaded into the ProtoTRAK SM CNC by using the INC SET or ABS SET key. X, Y, Z positions are referenced data. In entering any X, Y, or Z position data, you must note whether it is an incremental or absolute dimension and enter it accordingly. All other information (non-referenced data), such as tool diameter, feedrate, etc. is not a position and may, therefore, be loaded with either the INC SET or ABS SET key. This manual uses the term SET when either INC SET or ABS SET may be used interchangeably.

### 5.5 Incremental Reference Position in Programming

When X, Y, Z RAPID and Z data for the beginning position of any event are input as incremental data, this increment must be measured from some known point in the previous event. Following are the positions for each event type from which the incremental moves are made in the subsequent event:

**Position:** X, Y and Z programmed

**Drill:** X, Y, Z RAPID, and Z END programmed

**Bolt Hole:** X CENTER, Y CENTER, Z RAPID and Z END programmed

**Mill:** X END, Y END, Z RAPID and Z END programmed

**Arc:** X END, Y END, Z RAPID and Z END programmed

**Circle (POCKET or FRAME):** X CENTER, Y CENTER, Z RAPID and Z END programmed

**Rectangle or Irregular (POCKET or PROFILE):** X1 and Y1 corner, Z RAPID and Z END programmed

**Helix:** The X END, Y END, Z RAPID, and Z END programmed

**Sub:** The reference position as defined for the specific events above for the event prior to the first event that was repeated.

**A.G.E. PROFILE:** The appropriate reference position as defined for the specific events above for the last event that is programmed

For example, if an ARC event followed a MILL event, a 2.0 inch incremental X BEG would mean that in the X direction the beginning of the ARC event is 2.0 inches from the end of the MILL event.

## 5.6 Tool Diameter Compensation

Tool diameter compensation allows the machined edges shown directly on the print to be programmed instead of the center of the tool. The ProtoTRAK SM CNC then automatically compensates for the programmed geometry so that the desired results are obtained.

Tool cutter compensation is always specified as the tool either right or left of the workpiece while looking in the direction of the tool motion.

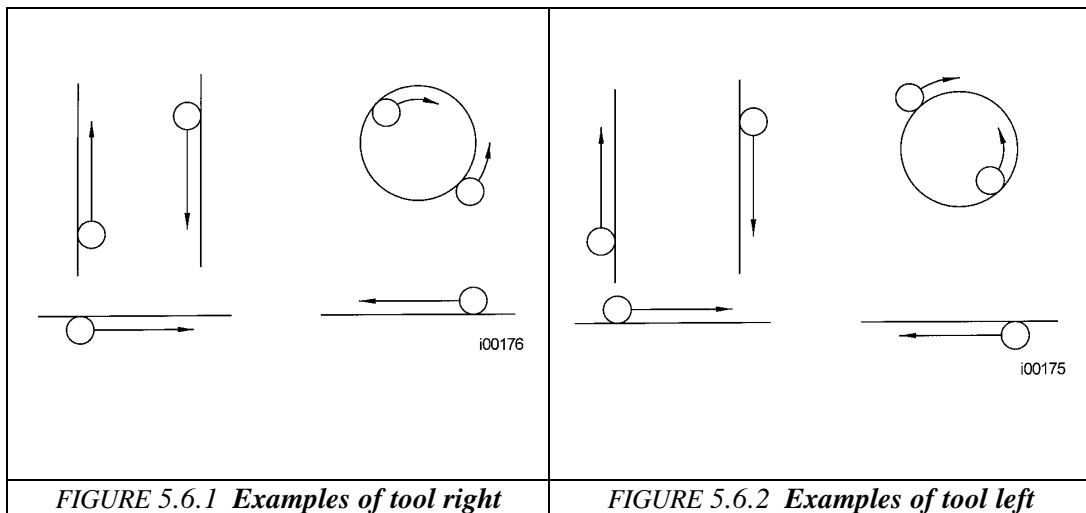

Tool center means no compensation either right or left. That is, the centerline of the tool will be moved to the programmed points.

## 5.7 Connective Events

Connective events occur between two milling events (either Mill or Arc) when the X, Y, and Z ending points of the first event are in the same location as the X, Y, and Z starting points of the next event. In addition, the tool offset and tool number of both events must be the same. And both events must lie in the XY plane or the same vertical plane (see Section 5.10).

## 5.8 Conrad

Conrad is a unique feature of the ProtoTRAK SM CNC that allows you to program a tangentially connecting radius between connective events, or tangentially connecting radii for the corners of pockets and frames without the necessity of complex calculations.

For the figure below, you program an Arc event from  $X1, Y1$  to  $X2, Y2$  with tool offset left, and another Arc event from  $X2, Y2$  to  $X3, Y3$  also with tool offset left. During the programming of the first Arc event, the system will prompt for Conrad at which time you input the numerical value of the tangentially connecting radius  $r=K3$ . The system will calculate the tangent points  $T1$  and  $T2$  and direct the tool cutter to move continuously from  $X1, Y1$  through  $T1, r=K3, T2$  to  $X3, Y3$ .

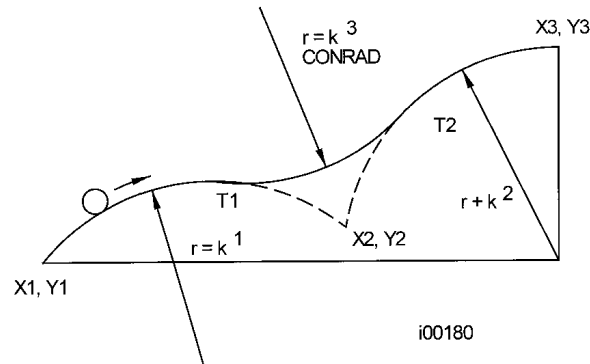

**FIGURE 5.8.1** A Conrad is added between the two intersecting lines

*Note: Conrad must always be the same as or larger than the tool radius for inside corners. If Conrad is less than the tool radius, and an inside corner is machined, the ProtoTRAK SM CNC will ignore the Conrad.*

For the figure below, you program an Arc event from  $X1, Z1$  to  $X2, Z2$ , and a Mill to  $X3, Z3$ . During the programming of the Arc event, the system will prompt for Conrad at which time you input the numerical value of the tangentially connecting radius  $r=k$ . The system will calculate the tangent points  $T1$  and  $T2$  and direct the tool cutter to move continuously from  $X1, Z1$  through  $T1, r=k, T2$  and on to  $X3, Z3$ .

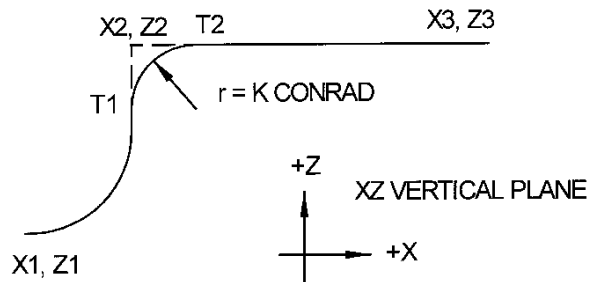

**FIGURE 5.8.2** A Conrad is added between an arc and a line

## 5.9 Memory & Storage

Computers can hold information in two ways. Information can be in **current memory** or in **storage**. Current memory (also known as RAM) is where the ProtoTRAK SM CNC holds the operating system and any part program that is ready to run. While a program is being written, it is in current memory. Storage of information is on the ProtoTRAK SM

CNC flash memory, a floppy disk or an offline computer connected to the ProtoTRAK SM CNC via the RS232 or network connection

## 5.10 Planes and Vertical Planes (Three-axis programming)

A plane is any flat surface. If that surface lies flat on the table, it is the XY plane. That is, if you move your finger along that surface or plane, you are moving in the X and/or Y direction, but not in Z (or at least not until you pick your finger up). If you tilted that surface (think of it as a piece of paper) straight up so that it faces the front of the machine, it would be in the XZ plane. If you tilted it up so that it faced left or right, it would be in the YZ plane.

A vertical plane is any plane (or surface) tipped up on its edge on the table (see below).

*Unlike most CNC controls, the ProtoTRAK SM CNC can machine arcs in any vertical plan rather than just XZ or YZ.*

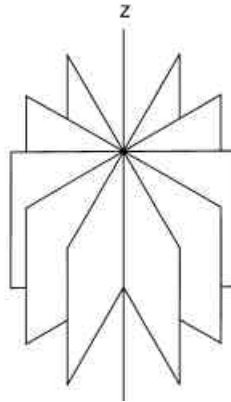

**FIGURE 5.10** Vertical planes

## 5.11 Tool Diameter Compensation when Contouring in Z with Part Geometry (Three-axis programming)

Left and right tool diameter offsets are always those projected into the XY plane. Tool offsets in the Z direction are always up and assume the use of a ball end mill. When contouring in the Z-axis, this up tool offset is always activated regardless of left, right, center if the Part Geometry option is selected. There is no Z-axis up tool offset applied when the Tool Path option is selected.

Special attention must always be paid to tool offsets when machining with a ball end mill. The reason for this is that the tool diameter changes in the bottom part (that portion equal to the tool radius) of the tool.

The tool is always positioned at the beginning of a milling operation so that the correct point on the ball end of the tool is tangent to the beginning point, and offset perpendicular to the machined edge by the radius of the tool. Consider the example below of milling a ramp in the XZ plane from point B to point C (see Figure 5.11).

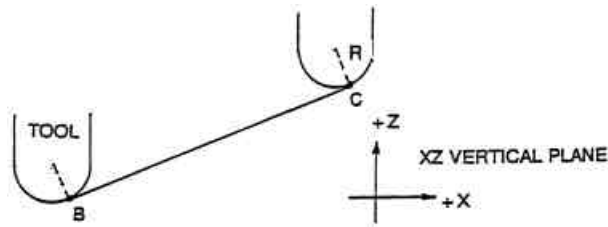

**FIGURE 5.11.1** Ball end mill position with respect to program points. Tool starts so end mill is tangent to BC. R from center of tool is perpendicular to BC

Note how the tool at the beginning point (point B) starts below (in the Z direction) point B so that it can actually touch this point. If this were not true, a cusp would remain to the left of point B.

Now consider a similar example milling from A to B to C in the XZ plane.

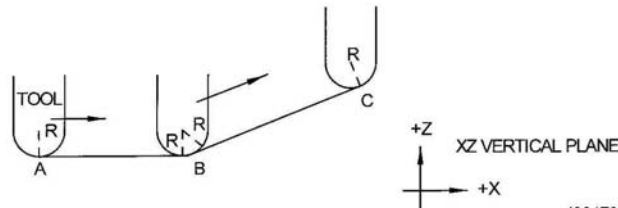

**FIGURE 5.11.2** In order to respect the lines defined by the programmed points, the ball end mill never touches point B. Tool starts centered over A offset up by the tool radius R. It moves right until it is tangent to both AB and BC. Then moves to point C as in the first example

Note the Tool at B does not drop below the AB line and, therefore, never touches point B. As a result, a fillet is formed at point B equal to the tool radius.

This second example of continuous machining from one cut (AB) to another (BC) with full cutter compensation between requires the two cuts to be made with events which are connective (see Section 5.7 or 5.8 for a more complete discussion of this requirement).

## 6.0 DRO MODE

The ProtoTRAK SM CNC operates in DRO Mode as a sophisticated 3-axis digital readout with jog and power feed capability.

### 6.1 Enter DRO Mode

Press **MODE**, select **DRO** soft key. The screen will show:

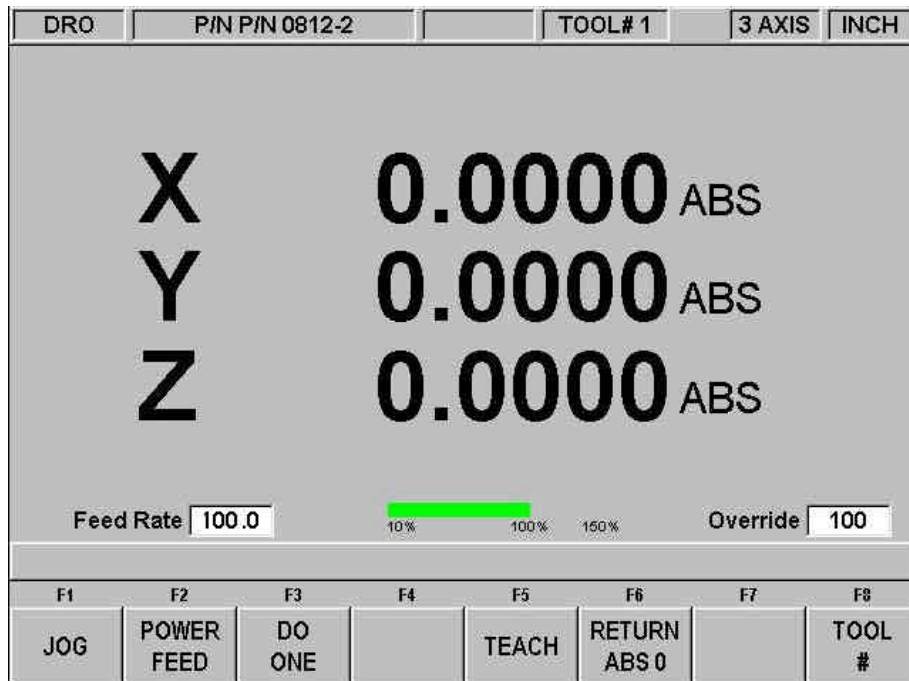

*FIGURE 6.1 The DRO screen*

Note the **RETURN** soft key is lit when in Jog or Power Feed operation.

### 6.2 DRO Functions

**Clear Entry:** Press RESTORE, then re-enter all keys.

**Inch to MM or MM to Inch:** Press IN/MM and note LCD screen status line.

**Reset One Axis:** Press X or Y or Z, INC SET. This zeros the incremental position in the selected axis.

**Preset:** Press X or Y or Z, numeric data, INC SET to preset selected axis.

**Reset Absolute Reference:** Press X or Y or Z, ABS SET to set selected axis absolute to zero at the current position.

*Note: This will also reset the incremental dimension if the absolute position is being displayed when it is reset.*

**Preset Absolute Reference:** Press X or Y or Z, numeric data, ABS SET to set the selected axis absolute to a preset location for the current machine position.

*Note: This will also reset the incremental dimension if the absolute position is being displayed when it is preset.*

**Recall Absolute Position of All Axes:** Press INC/ABS. Note the dimension for each axis is labeled INC or ABS. Press INC/ABS again to revert to the original reading.

**Recall Absolute Position of One Axis:** Press X or Y or Z, INC/ABS. Note the INC or ABS label for each axis. Repeat to get selected axis back to original reading.

### 6.3 Jog

The servomotors can be used to jog the table, saddle and ram.

- a. Press the **JOG** soft key.
- b. A flashing message will appear saying "CAUTION: JOG KEYS ARE ACTIVE".
- c. To jog, press the X, Y or Z\* hard keys.
- d. To stop jogging, release the key.
- e. The speed of jog is displayed in the box next to the words "Feed Rate" on the lower left side of the LCD screen.
- f. Press the +/- hard key to reverse direction. When the number in the Feed rate box is negative, this indicates the minus direction.
- d. Press the RATE keys to reduce and to increase the jog speed in 10 percent increments. The changes in speed may be seen in the Feed rate box and on the green feed rate indicator. The amount of override is displayed in the Override box.
- g. To jog at a certain rate, simply enter that number as inches or mm per minute and then press the X, Y or Z\* key. You may also use the override key to adjust this number. Press **RSTR** to return to 100 ipm or 2540mm.
- h. Press **RETURN** soft key to return to manual DRO operation.

\* Z axis jog available for the three-axis CNC only.

### 6.4 Power Feed

The servomotors can be used as a power feed for the table, saddle (or quill), or all three simultaneously.

- a. Press the **POWER FEED** soft key.
- b. A message box will appear that shows the power feed dimensions. All power feed moves are entered as incremental moves from the current position to the next position.
- c. Enter a position by pressing the axis key, the distance to go and the +/- key (if needed). Input the entry by pressing INC SET. For example, if you wanted to make a power feed move of 2.00" of the table in the negative direction, you would enter: X, 2, +/-, INC SET.

- d. Initiate the power feed move by pressing GO.
- e. The feedrate is automatically set to 10 ipm (or 254 mm per min). Press **FEED** ↑ or **FEED** ↓ to adjust the feedrate from 1 ipm to 100 ipm. (or 254 to 2540)
- f. Press **STOP** to halt power feed. Press **GO** to resume.
- g. Repeat the process beginning at "c" above as often as you wish.
- h. Press **RETURN** soft key to return to manual DRO operation.

## 6.5 Do One

The Do One routines in the DRO mode allow you to do one CNC operation while machining manually without having to write a program.

The programming and tool path of the events in Do One are nearly identical to those in the Program Mode. See Section 8 and 9 for programming instructions.

## 6.6 Teach

Teach gives you the ability to enter X and Y dimensions into a program. It can be a useful way of entering a few manual moves for operations like clearing out excess material or remembering a few hole locations.

The process of using Teach is in two parts. The first part takes place in the DRO Mode. This is where you start the Teach program, establish the program events and enter the X and Y dimensions. The second part is in the Program Mode. This is where you complete the Teach events that you began in the DRO Mode by entering the rest of the data. Once the data is entered, the Teach events become just like the other events that make up a program.

### 6.6.1 Entering Teach Data

From the DRO screen, press Teach.

On the top of the screen, you will see the message "Teach" and an event counter. When you enter Teach, you are actually programming events. If there is already a program in current memory, Teaching will add events to the end of the program. If there is not already a program in current memory, Teaching will start a new program. For example, if you already had a program in current memory that had 10 events, when you press Teach, the event counter will say EVENT 11. If there was no program, the event counter will say EVENT 1.

The event counter shows the event for which data is being entered. You may teach in position, drill and mill events only.

On the first Teach screen, the softkeys are:

**POSN:** a position move. For two-axis programming, the POSN and DRILL events are combined.

**DRILL:** a drill or bore.

**MILL BEGIN:** the beginning of a straight line or MILL event.

**END TEACH:** ends the teaching process and returns you to the main DRO screen.



If you press the POSN or DRILL key, the event counter will go up by one and the screen remains the same. If you press the MILL BEGIN key, the event counter stays on the same number. That is because you have given the beginning point of the line but not yet the end. The softkey selections will change to:

**MILL END:** the last point of the Mill event. Press this to end the Mill event and select a POSN, DRILL or new MILL event.

**MILL CONT:** the last point of the current Mill event, but the beginning of the next Mill event. You may enter successive Mill events by pressing the MILL CONT key.

Pressing either of the above softkeys will cause the event counter to increase by one.

At any time you may exit the Teach and return to the DRO screen. The events you have defined with their X and Y dimensions are finished in the Program Mode. See Section 8.10 for finishing two-axis Teach events or section 9.14 for finishing three-axis Teach events.

## 6.7 Return to Absolute Zero

At any time during manual DRO operation you may automatically move the table to your absolute zero location in X and Y by pressing the **RETURN ABS 0** soft key. When you do, the message window will read "Ready to Begin: Press Go when Ready". Make sure your tool is clear and press the **GO** key. The table will move at rapid speed to your X and Y absolute zero position. You will be at zero and in manual DRO operation.

## 6.8 Tool #

The ProtoTRAK SM CNC allows you to use the offsets for tools in your Tool Table (see Section 12.1) in the DRO Mode. To change tools, press the TOOL # soft key and enter the tool number when prompted by the Data Input Line.

Even when you set up a tool in the Set-Up Mode, if you do not wish to use the tools in the Tool Table, simply ignore the Tool # feature.

# 7.0 Program Mode

## Getting Started & Some General Information

### 7.1 Programming Overview

The ProtoTRAK SM CNC makes programming easy by allowing you to program the actual part geometry as defined by the print.

The basic strategy is to first fill in the initial program information in the Program Header screen and then program the features of the part by selecting the soft key event types (geometry) and then follow all instructions in the Data Input Line.

When an event is selected, all the prompts that need to be input will be shown on the right side of the screen. The first prompt will be highlighted and also shown in the Data Input Line. Input the dimension or data requested and press **INC SET** or **ABS SET**. For X or Y dimension data it is very important to properly select **INC SET** or **ABS SET**. For all other data either **SET** will do.

As data is being entered it will show in the Data Input Line. When **SET**, the data will be transferred to the list of prompts in the right side of the screen, and the next prompt will be shown in the Data Input Line.

When all data for an event has been entered, the entire event will be shifted to the left side of the screen and the conversation line will ask you to select the next event.

### 7.2 Enter Program Mode

Press **MODE**, select **PROGRAM** soft key.

The ProtoTRAK SM CNC will allow only one program in current memory. To write a new program, you must first erase the one in current memory (you may want to first store the program for use in the future). If there is already a program in current memory, entering the Program mode will allow you to edit or add to that program.

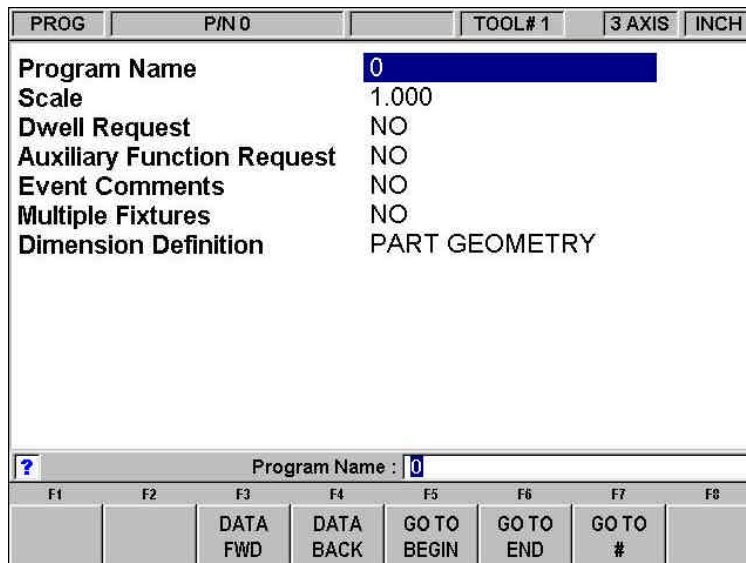

FIGURE 7.2 The Program Mode header screen

## 7.3 Program Header Screen

The first screen you see when you enter the Program Mode is the Program Header Screen. The Program Header Screen gives you options that apply to the entire program. The softkey selections allow you to enter the program at any point.

The program name and general programming options you choose in the Program Header Screen will be summarized in the program as "Event 0".

### 7.3.1 Program Name

Programs written on the ProtoTRAK SM CNC are usually named for the part that is to be machined. When programs (or files) are named using the ProtoTRAK SM CNC, the name can be up to 20 characters long. Programs imported into the ProtoTRAK SM CNC may be longer. While 20 characters are allowed, the entire program name may not be shown in the status line or the program header screen.

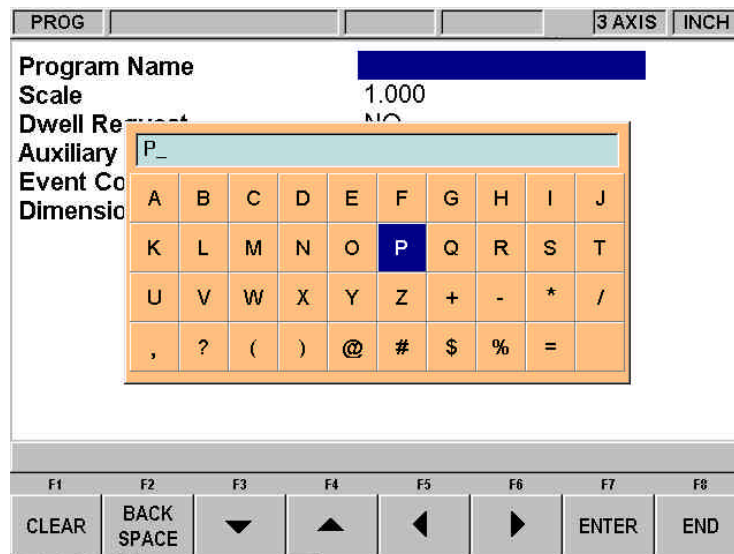

**FIGURE 7.3** Pressing the Help hard key when the Program Name is highlighted calls up alpha keys

Program names can include numbers, letters, spaces and other characters. When the Program name prompt is highlighted, the Data Input Line will show "Program Name:". At this point you may:

- Press number keys.
- Press Help to access alpha keys and special characters in the ProtoTRAK SM CNC.
- Use a keyboard plugged into the ProtoTRAK SM CNC to name the program.

To use the alpha keys and special characters on the ProtoTRAK SM CNC:

- Use the Clear softkey to erase the entire line; the Backspace softkey to erase the last character or number.
- Use the arrow softkeys to move around the table.
- Once the character you want is highlighted, use the Enter softkey to load the character into the program name.

- Use the blank space on the lower right of the table to insert a space into the program name.
- Once you finish entering the letters and special characters, press the End softkey. This tells the ProtoTRAK SM CNC that you are finished with the alpha table. Numbers may still be added to the program name.

When you are finished with the program name, press SET to enter it into the current memory.

*Note: It is not necessary to enter a part number. If none is entered and a GO TO soft key is pushed, the system will assume a part number 0.*

### 7.3.2 General Program Options

Use the DATA FWD softkey to select general programming options..

**Scale:** Allows a scale factor between .1 and 10. An input of 5 means the part will be 5 times as big as the programmed dimensions. A value of 1.0000 is assumed if nothing is input.

**Dwell Request:** Allows you to input a dwell at the bottom of a drill bolt hole or bore cycle for events you select. Select the appropriate **YES** or **NO** soft key. If you select **YES** you will be prompted to input a dwell time in seconds from .1 to 99.9 when appropriate to the event being programmed.

**Auxiliary Function Request:** Asks if you wish to activate any of the optional auxiliary functions (see Section 7.4) at any time during the program. Select the appropriate **YES** or **NO** soft key. If you select **YES** you will be prompted to input the type and sequencing of the auxiliary functions during event programming.

**Event Comments:** If you select "Yes" for event comments, you will have the opportunity to insert a comment in each event. For Irregular Pocket and Irregular Profile events, you will be able to enter a comment at the header event, but not for each A.G.E. Turn and A.G.E. Arc event.

The comment you insert will appear in the RUN mode on the screen just above the X position dimension as the event begins to run. Comments may be composed of letters, numbers and some symbols and may be up to 20 characters.

While programming the event with the Event Comments set to Yes, when the highlight is on the Event Comments prompt, you may enter a comment using the same methods used to enter a program name, as described above.

**Multiple Fixtures:** Asks you if you wish to turn on the multiple fixtures offset. Answering Yes will cause a prompt to appear at each event asking which fixture the event was referenced from. If you select Yes, the Data Input Line will ask you to enter a fixture default number from one to six. The fixture default number is the fixture that will be applied to all the events in current memory when Multiple Fixtures is turned on or when a new event is programmed without another event being specified. Enter the default fixture, or leave the number unchanged, and press SET. Multiple Fixtures are explained more fully in Section 7.5.

**Dimension Definition:** The ProtoTRAK SM CNC gives you a choice in programming either tool path or geometry. Part Geometry programming allows you to define the geometry you want your part to have and then the CNC does the difficult job of calculating tool path for you automatically. This is a great benefit for most parts most of the time because it means that the CNC is doing the hard work of determining tool position.

One restriction to part geometry programming is that for events to be connective, they must lay on the same vertical plane (see Section 5.10 for a definition of vertical planes). For this reason, the ProtoTRAK SM CNC gives you the option of entering your own tool path. If you wish to program the part by defining tool path yourself, you may choose the TOOL PATH softkey. Otherwise, Part Geometry programming is assumed. Tool Path operates under the same rules as Haas standard RS274.

A program must be entirely written in Part Geometry or Tool Path programming, you cannot combine the two methods in one program.

### 7.3.3 Program Header Softkeys

The following softkeys are encountered in the Program Header Screen. The first five listed below are always there. The last four appear when relevant to the general programming option.

**DATA FWD:** moves the highlight forward through the programming options without setting an input into the program.

**DATA BACK:** moves the highlight backward through the programming options without setting an input into the program.

**GO TO BEGIN:** puts the Program Header on the left side of the screen and the first event on the right side.

**GO TO END:** puts the last programmed event on the left side of the screen and the next event to be programmed on the right side.

**GO TO #:** enter the event number you wish to go to and then press SET. Puts the requested event number on the right side of the screen and the previous event number on the left.

*Note: for a new program that has no Events, all the GO TO selections will take you to the beginning, with the program header information summarized on the left (as Event 0) and the Select an Event options for Event 1 on the right.*

**YES and NO:** Yes and no appear when the Dwell Request, Auxiliary Function Request and the Event Comments are highlighted. Choosing Yes will give you prompts for using these options while you are programming. You may return to the Program Header Screen at any time to choose or cancel these prompts.

**PART GEO:** sets up the programming as Part Geometry.

**TOOL PATH:** sets up the programming as Tool Path.

## 7.4 Auxiliary (AUX) Functions (Three-axis CNC programming only)

The ProtoTRAK SM CNC can control four different auxiliary functions. You can select whether to activate or deactivate these functions at the beginning or end of each event.

If Auxiliary Functions are selected on the program header, the system will prompt for AUX BEG and AUX END in each event.

When running programs with Auxiliary functions, the ACCESSORY hard key on the front panel must be in the correct position. If you want the program to automatically turn the Auxiliary functions on and off, press the ACCESSORY key until the light is on in the AUTO position.

### AUX BEG options:

Input:	Function	Comments
0	None	No Auxiliary functions will begin when this event begins to run.
1	Coolant/Air	The coolant pump or air solenoid will be turned on when this event begins to run.
3	Pulse indexer	Activates a 0.3 second electronic pulse at the beginning of the event. See note below.

### AUX END options:

0	None	No Auxiliary functions will turn off at the end of this event.
1	Coolant off	Turns the coolant or air solenoid off at the end of this event.
3	Pulse Indexer	Activates a 0.3 second electronic pulse at the end of this event. See note below.

Coolant/Air on and off is automatically programmed for tool changes. If you want the air or coolant pump on while cutting the entire part, you need only program the Aux begin in the first event and Aux end in the last event. The coolant pump or air solenoid will turn on at the beginning of the programmed event and will turn off during tool changes.

The Pulse Indexer function is designed to operate with a standard indexer. Programming an Aux 3 at the end of an event will cause the ProtoTRAK SM CNC to stop machining at the end of the event and wait for a signal from the indexer or rotary table that it has finished its programmed move, then it will resume machining at the next event. If you want the ProtoTRAK SM CNC to return the head to the Z retract position before moving to the next event, put the Aux 3 command in a Pause event. The ProtoTRAK SM CNC will interpret the signal from the indexer or rotary table as a GO command and continue machining without you having to press the GO key.

## 7.5 Multiple Fixtures

You may run your program using up to six fixtures plus a base. A fixture is a location on your machine with a defined offset from your absolute 0. When you program an event to have a fixture, it will treat the offset as if it were absolute zero shift. The programmed X, Y and Z absolute dimensions are relative to the absolute reference for the specified fixture.

For example, say you had two vises on the table. On the first vise, you established the lower left jaw as the absolute 0. At the same time, you measured the distance between the absolute zero you just established and the lower left jaw of the other vise. You entered that measurement as an offset from your base vise (the first one) and the other vise, which is fixture #2. Any events that you programmed using fixture #2 would treat the lower left corner of that second vise like the absolute 0 for the X, Y and Z dimensions in the events.

Fixture offsets are handy for combining different programs together to run at the same time or to make multiple parts by repeating the events with different fixtures.

The fixture offsets are entered in the Set-up mode. There is a base fixture, called fixture number one. We recommend that event # 1 in your program uses fixture number one. It doesn't have to, we just believe it is clearer that way.

### 7.5.1 The Default Fixture

In the program header screen, you entered a default fixture number (if you didn't, it assumed fixture #1 as the default fixture). If there are program events already in current memory when you change the multiple fixture from NO to YES, they will all receive the default fixture number automatically. When you change the default fixture number in the program header screen from one fixture to another, all the events that had the previous default fixture number will be changed to the new default fixture number.

If there are no program events in current memory when you change the multiple fixture feature from NO to YES, the prompt will be added to the end of every event you then program. The default fixture number will be assumed if you press SET without specifying a different number. If you do specify a different fixture number that fixture number will become the assumed input for subsequent events when SET is pressed.

### 7.5.2 Fixtures and Running the Program

To run the program, first go to the DRO mode and set absolute 0 at the base fixture, fixture #1.

In the Run mode, the SHOW ABS displays the absolute position relative to the fixture in the event being run, that is, the absolute dimension that was programmed.

### 7.5.3 Editing Fixtures

With the Multiple Fixtures featured turned to YES, you may edit the fixture number in the Program Mode event by event. You may also use the Search Edit feature in the Edit Mode to change fixture numbers.

See Section 11.4 for setting up fixture offsets

## 7.6 Assumed Inputs

The ProtoTRAK SM CNC will automatically program the following when you simply press SET (either INC SET or ABS SET):

**Tool Offset:** If the first event with an offset, CENTER. If not the first event with an offset, the same as the last event if that event was a Mill or Arc event

**Feedrate:** same as last event if that event was a Mill, Arc, Pocket, Frame, or Helix

**Tool #:** same as last event, or Tool #1 if the first event.

**DRILL OR BORE:** Drill

**# PECKS FOR DRILL:** 1 peck

**CONRAD:** 0

You may change these assumed inputs by simply inputting the desired data when the event is programmed.

## 7.7 Z Rapid Positioning (Three-axis CNC programming only)

Between any two events the head will always move to the higher of the Z rapid of the event just completed or the Z Rapid of the next event, unless the two events are connective (see Section 5.7). Remember, when using part geometry programming, two milling events are not connective unless they lie in the same plane.

## 7.8 Softkeys within Events

Once a geometry (Event) such as Mill or Bolt Hole is selected, the softkeys will change. See Figure 7.8

F1	F2	F3	F4	F5	F6	F7	F8
PAGE FWD	PAGE BACK	DATA FWD	DATA BACK	DATA BOTTOM	INSERT EVENT	DELETE EVENT	

**FIGURE 7.8** Soft keys used while programming an event

**PAGE FWD:** moves forward through the programmed events.

**PAGE BACK:** moves backwards through the programmed events.

**DATA FWD:** moves forward through the event inputs. Note, use the DATA FWD key and not a SET key when you do not want to input a value.

**DATA BACK:** moves backwards through the event inputs.

**DATA BOTTOM:** puts the Highlight on the last input.

**INSERT EVENT:** use this to insert a new event into the program. This new event will take the place of the one that was on the right side of the screen when you pressed the INSERT EVENT key. That previous event, and all the events that follow, increase their event number by one. For example, if you started with a program of four events, if you were to press the INSERT EVENT key while Event 3 was on the right side of the screen, the previous Event 3 would become Event 4 and the previous Event 4 would become Event 5. If you insert a Subroutine event, the event numbers will increase by one as when you insert another kind of event. If you insert a copy event, the event numbers will increase by the number of events that are copied.

**DELETE EVENT:** this will delete the event on the right side of the screen.

## 7.9 Programming Events

Once you press the appropriate GO TO soft key, you will begin to define your part as a series of Events. For the ProtoTRAK SM CNC, an Event is a geometry, or a feature of a part.

PROG	P/N 0	TOOL# 1	3 AXIS	INCH			
<b>EVENT 0</b>		<b>EVENT 1</b>					
PROGRAM NAME 0							
SCALE 1.000							
DWELL REQUEST NO							
AUXILIARY FUNCTION NO							
EVENT COMMENTS NO							
MULTIPLE FIXTURES NO							
DIMENSION DEFINITION PART GEO							
Select an event							
F1	F2	F3	F4	F5	F6	F7	F8
POSN	DRILL	BOLT HOLE	MILL	ARC	POCKET	PROFILE	MORE

01052

**FIGURE 7.9.1** The header screen has been completed and is on the left side. Select an event type from the soft keys. Shown here are the events for three-axis CNC programming.



When the MORE soft key is selected, the soft keys change to:



i01062

**FIGURE 7.9.2** When the More soft key is selected, these additional event types are available in three-axis CNC programming.

After an event type is selected from the soft keys, the prompts for that event will appear on the right side of the screen. The data you need to enter to program the event will appear in the Data Input Line. As soon as you enter one piece of data by pressing the INC SET or ABS SET key, the next prompt will appear in the Data Input Line.

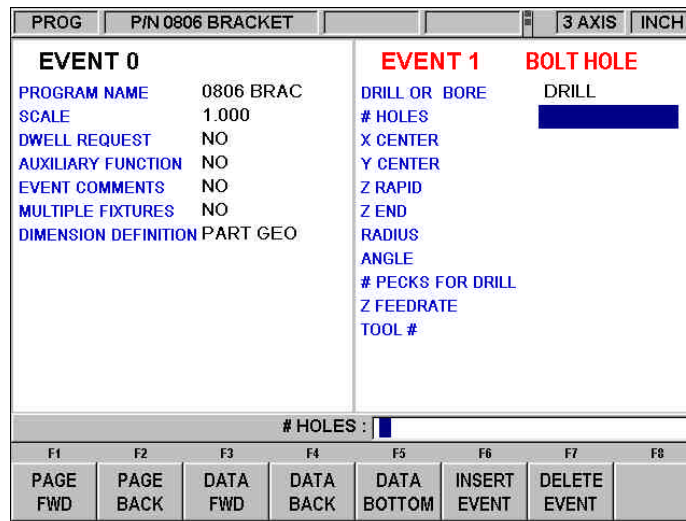

i01061

**FIGURE 7.9.3** Here, a Bolt Hole event was selected. The ProtoTRAK SM CNC is prompting you to enter the number of holes

## 7.10 Editing Data While Programming

While programming an event, all data is entered by pressing the appropriate numeric keys and pressing **INC SET** or **ABS SET**. If you enter an incorrect number before you press **INC SET** or **ABS SET** you may clear the number by pressing **RSTR** (Restore). Then, input the correct number and press **SET**.

If incorrect data has been entered and **SET**, you may correct it as long as you are still programming that same event. Press the **DATA BACK** or **DATA FWD** (Forward) soft key until the incorrect prompt and data are highlighted and shown in the conversation line. Enter the correct number and **SET**. The ProtoTRAK SM CNC will not allow you to skip past prompts (by pressing **DATA FWD**) which need to be entered to complete an event except when using the A.G.E. in the Irregular Pocket or Irregular Profile event.

Previous events may be edited by pressing the **BACK** hard key to the left of the soft keys. The previous event will be shifted from the left side of the screen to the right and may be edited. The **BACK** key may be pressed all the way to the Program Header Screen (the **PAGE BACK** softkey will work as well).

## 7.11 LOOK

As you program each event, it is helpful to see your part drawn. For quick graphics while in the Program Mode, press the LOOK hard key.

This function is active at the end of each event, or whenever the conversation line is prompting Select Event. Press the LOOK key and the ProtoTRAK SM CNC will draw the part. Press LOOK again, or BACK to bring back the Select Event screen. You may also select a new view or adjust the view.

### Softkeys in LOOK:

**ADJUST VIEW:** gives additional options for adjusting the view of the drawing. See below.

**FIT DRAW:** automatically resizes the drawing to fit the entire part program on the screen.

**LIST STEP:** displays the list of events on the left side of the screen and with a purple highlight on the first event. As LIST STEP is pushed, the highlight shifts to the next event. As this happens, that event is also highlighted in the graphics by having its color change to purple.

**START EVENT NUMBER:** will prompt you to enter an event number for highlighting. This is useful for moving quickly to a particular event in a large program.

**XY:** displays a view in the XY plane.

**YZ:** displays a view in the YZ plane.

**XZ:** displays a view in the XZ plane.

**3D:** displays an isometric view

### Softkeys in Adjust view:

**FIT DRAW:** automatically resizes the drawing to fit the entire part program on the screen.

▼ : shifts drawing down.

▲ : shifts drawing up.

◀ : shifts drawing to the left.

▶ : shifts drawing to the right.

**ZOOM IN:** makes the drawing larger.

**ZOOM OUT:** makes the drawing smaller

**RETURN:** returns you to the first LOOK screen. The adjustments you made will stay on the screen until you press another selection that overrides those adjustments. The LIST STEP function may be used with the adjustment unaltered.

*Note: The LOOK routine does not check for programming errors. Use Tool Path in the SET UP Mode to check movement of the tool.*

## 7.12 Finish Cuts

The Pocket and Profile events are designed with built-in finish cut routines because they are complete, and stand-alone pieces of geometry. Shapes machined with a series of Mill or Arc events (either with or without A.G.E. Profile) don't have an automatic routine for making finish cuts. There is, however, a very simple technique that can be used.

- a. Program the shape using the print dimensions, and ignore the need to leave material for a finish cut.
- b. Using a subroutine event, Repeat all the events in "a." but call out a different tool number.
- c. In Set-Up Mode "lie" about the tool diameter for the tool called out in events in "a.". Input a tool diameter equal to the actual tool diameter plus 2 times the finish cut you wish to leave. The ProtoTRAK SM CNC will think the tool is bigger than it really is and, therefore, shift a little further away from the machined shape.
- d. In Set-Up Mode input the actual diameter for the tool called in the Repeat event "b". This will produce the final dimensioned cut.

### 7.13 Two Versus Three-Axis Programming

The ProtoTRAK SM CNC three-axis CNC models may be operated as either a two or three-axis CNC. Many jobs in tool rooms are simply easier to do with a two-axis CNC. Many jobs are more complex or require a lot of metal removal, so the extra programming and set-up of the three-axis is worth the effort.

The ProtoTRAK SM CNC lets you choose how much CNC you want to use on the job at hand. See Section 4.4 for switching between two and three-axis operation.

Programming is very similar between the two.

EVENT 1	BOLT HOLE	EVENT 1	BOLT HOLE
DRILL OR BORE		# HOLES	
# HOLES		X CENTER	
X CENTER		Y CENTER	
Y CENTER		RADIUS	
Z RAPID		ANGLE	
Z END		TOOL #	
RADIUS			
ANGLE			
# PECKS FOR DRILL			
Z REEDRATE			
TOOL #			

**FIGURE 7.13** Programming a Bolt Hole. On the left, the prompts required in programming in three-axis CNC. On the right, the prompts required for two-axis.

In Figure 7.13 the prompts for programming a Bolt Hole in two-axis and in three-axis are shown side by side. Note that the difference is that the three-axis requires a few additional prompts.

## 8.0 Two-Axis Program Events

This section describes the events and prompts you encounter when programming your ProtoTRAK SM as a two-axis CNC.

Events are fully defined pieces of geometry. By programming events, you tell the ProtoTRAK SM CNC what geometry you want to end up with; it figures the tool path for you from your answers to the prompts and the tool information you give it in the Set-Up Mode.

### 8.1 POSN DRILL:

This event type positions the table and quill at a specified position. The positioning is always at rapid speed (modified by feedrate override) and in the most direct path possible from the previous location. You would use this event type to program a hole for drilling. In program run, the CNC will move to the dimension you program and will wait for you to press GO before moving to the next event. You may also use this event type to position the table for some other purpose, such as to avoid a clamp or to move off the workpiece for a tool change.

To program a Position event press the **POSN DRILL** soft key.

Prompts for the Position event:

**X END** is the X dimension to the position

**Y END** is the Y dimension to the position

**Tool #** is the tool number you assign. SET will use the tool number of the previous event.

### 8.2 BOLT HOLE Events

This event allows you to program a bolt hole pattern without needing to compute and program the position of each hole.

Prompts for the Bolt Hole event:

**# Holes:** is the number of holes in the bolt hole pattern

**X Center:** is the X dimension to the center of the hole pattern

**Y Center:** is the Y dimension to the center of the hole pattern

**Radius:** is the radius of the hole pattern from the center to the center of the holes

**Angle:** is the angle from the positive X axes (that is, 3 o'clock) to any hole; positive angle is measured counterclockwise from 0.000 to 359.999 degrees, negative angles measured clockwise.

**Tool #:** is the tool number you assign

### 8.3 MILL Events

This event allows you to mill in a straight line from any one XYZ point to another, including at a diagonal in space. It may be programmed with a CONRAD if it is connective with the next event.

Prompts for the Mill event:

**X Begin:** is the X dimension to the beginning of the mill cut

**Y Begin:** is the Y dimension to the beginning of the mill cut

**X End:** is the X dimension to the end of the mill cut; incremental is X Begin

**Y End:** is the Y dimension to the end of the mill cut; incremental is Y Begin

**Conrad:** is the dimension of a tangential radius to the next event (that must lie in the same plane for part geometry programming)

**Tool Offset:** is the selection of the tool offset to right (input 1), offset to left (input 2), or tool center--no offset (input 0) relative to the programmed edge and direction of tool cutter movement and as projected in the XY plane.

**Feedrate:** is the milling feedrate from Begin to End in in/min from .1 to 100, or mm/min from 5 to 2540

**Tool #:** is the tool number you assign

**Continue:** input 1 for Yes if you want to mill continuously from this line to the next event, input 2 for No if you want the ProtoTRAK SM to stop at the end of the event.

## 8.4 ARC Events

This event allows you to mill with circular contouring any arc (fraction of a circle).

In ARC events when X Center and Y Center are programmed incrementally, they are referenced from X End and Y End respectively. An ARC event may be programmed with a CONRAD if it is connective with the next event.

Prompts for the Arc event:

**X Begin:** is the X dimension to the beginning of the arc cut

**Y Begin:** is the Y dimension to the beginning of the arc cut

**X End:** is the X dimension to the end of the arc cut; incremental is from X Begin

**Y End:** is the Y dimension to the end of the arc cut; incremental is from Y Begin

**X Center:** is the X dimension to the center of the arc; incremental is from X End

**Y Center:** is the Y dimension to the center of the arc; incremental is from Y End

**Conrad:** is the dimension of a tangential radius to the next event

**Direction:** is the clockwise (input 1), or counterclockwise (input 2) direction of the arc

**Tool Offset:** is the selection of the tool offset to right (input 1), offset to left (input 2), or tool center--no offset (input 0) relative to the programmed edge and direction of tool cutter movement

**XY Feedrate:** is the milling feedrate from Begin to End in in/min from .1 to 100, or mm/min from 5 to 2540

**Tool #:** is the tool number you assign

**Continue:** input 1 for Yes if you want to mill continuously from this line to the next event, input 2 for No if you want the ProtoTRAK SM to stop at the end of the event.

## 8.5 POCKET Event

This event selection gives you a choice between circle pocket, rectangular pocket and irregular pocket.

Pockets include machining the circumference, as well as all the material inside the circumference of the programmed shape. If a finished cut is programmed, it will be made at the completion of the final pass. The cutter will arc in and arc out of the finish cut and position itself the finish cut dimension away from the part before moving the tool out of the part.

The factory setting for tool stepover while machining a pocket is 70%. This may be changed. When you first enter the pocket event, the blue ? will appear next to the help key. Pressing Help will give you the choice of entering a new tool stepover percentage. The value you enter here will remain the same until you change it again.

### 8.5.1 Circular Pocket

Press the **CIRCLE PCKT** soft key if you wish to mill a circular pocket.

Prompts for the circle pocket:

**X Center:** is the X dimension to the center of the circle

**Y Center:** is the Y dimension to the center of the circle

**Radius:** is the finish radius of the circle

**Direction:** is the clockwise (input 1), or counterclockwise (input 2) direction for milling

**Fin Cut:** is the width of the finish cut. If 0 is input, there will be no finish cut.

**Feedrate:** is the milling feedrate in in/min from .1 to 100, or mm/min from 5 to 2540

**Fin Feedrate:** is the milling feedrate for the finish cut

**Tool #:** is the tool number you assign

### 8.5.2 Rectangular Pocket

Press **RECTANGLE** soft key if you wish to mill a rectangular pocket (all corners are 90° right angles and the sides are parallel to the X and Y axes).

The prompts for the rectangular pocket:

**X1:** is the X dimension to any corner

**Y1:** is the Y dimension to the same corner as X1

**X3:** is the X dimension to the corner opposite X1; incremental is from X1

**Y3:** is the Y dimension to the same corner as X3; incremental is from Y1

**Conrad:** is the value of the tangential radius in each corner

**Direction:** is the clockwise (input 1), or counterclockwise (input 2) direction for milling

**Fin Cut:** is the width of the finish cut. If 0 is input there will be no finish cut

**XY Feedrate:** is the milling feedrate in in/min from .1 to 100, or mm/min from 5 to 2540

**Fin Feedrate:** is the milling feedrate for the finish cut

**Tool #:** is the tool number you assign

### 8.5.3 Irregular Pocket

Press the **IRREG PCKT** soft key if you wish to mill a pocket other than a rectangle or circle. The Irregular Pocket event gives you the powerful Auto Geometry Engine to define a shape made up of straight lines (Mills) and arcs.

The first screen in an irregular pocket event will define the beginning point and some of its general parameters. The last event of the irregular pocket must end at the same point as defined in the first event.

**X Begin:** is the X dimension of the beginning of the pocket

**Y Begin:** is the Y dimension of the beginning of the pocket

**Fin Cut:** is the width of the finish cut. If 0 is input there will be no finish cut

**Feedrate:** is the milling feedrate in in/min from .1 to 100, or mm/min from 5 to 2540

**Fin Feedrate:** is the finish cut milling feedrate in in/min from .1 to 100, or mm/min from 5 to 2540

**Tool #:** is the tool number you assign

When the initial screen is complete, you will define the perimeter of the pocket with a series of A.G.E. Mills and A.G.E. Arcs. Programming with the Auto Geometry Engine is explained in Section 10.0.

No islands may exist in an irregular pocket.

#### 8.5.4 Tool Path in Pocket Events

In Program Run, the ProtoTRAK SM will first direct the cutter along a path to rough out all the material inside of the perimeter, and then will do a rough cut along the inside of the perimeter which leaves the amount of material programmed in the FIN CUT prompt. This will be followed by a finish pass (if FIN CUT was not zero) along the inside of the perimeter at the Finish Feedrate.

Whether the cuts to clear the interior material of the irregular pocket are along the X or Y-axis depends on if there are hidden areas of the pocket. The ProtoTRAK SM CNC always looks to cut along the X-axis first. If there are areas that are hidden to the X-axis, it will machine along the Y-axis. If there are hidden areas that cannot be machined continuously in the X or Y-axis, the pocket will be machined in two or more steps. When a step is completed, the ProtoTRAK SM will prompt "CHECK Z" at which time you should raise your quill out of the pocket. Press GO and the tool will move at rapid to the beginning of the next step and then there will be a prompt for you to "SET Z" for you to position the tool for the depth you want.

In the Set Up Mode, you may check your tool path for hidden areas. The yellow X's show points where you will receive a prompt to move the quill. The red dashed lines show the rapid moves.

#### 8.5.5 Conrad in Pocket Events

A conrad may be added to the last event of an Irregular Pocket. The conrad will be inserted between the end of the last event and the beginning of the next event.

### 8.6 Islands

Within the Pocket event choices, you may also select a circular, rectangular or irregular island. An island is a shape that is left standing when the surrounding material is removed. The ProtoTRAK gives you the ability to machine almost any shape as an island within a rectangular pocket. Both the shape of the island and the dimension of the surrounding pocket are defined within the island event.

The tool path for machining the island event is that the tool will machine the perimeter of the island, offset by the island finish cut. Then the tool will machine the material in the pocket in a spiral path, moving away from the island in the programmed clockwise or counterclockwise direction. It will continue this outward spiral motion until it encounters the programmed rectangular perimeter (or pocket). It will then follow the perimeter, offset by the pocket finish cut.

#### 8.6.1 Circular Island

Press the Circle Island soft key if you wish to mill a circular island.

Prompts for the Circle Pocket:

**X CENTER:** is the dimension of the center of the Island

**Y CENTER:** is the dimension of the center of the Island

**RADIUS:** is the finish radius of the Island

**DIRECTION:** is the milling direction, clockwise or counterclockwise

**FIN CUT ISL:** Finish cut for the Island. If 0 is input, there will be no finish cut.

**X1 POCKET:** X dimension for one corner of the rectangular pocket that surrounds the island.

**Y1 POCKET:** Y dimension for one corner of the rectangular pocket that surrounds the island.

**X3 POCKET:** X dimension for the opposite corner of the rectangular pocket that surrounds the island.

**Y3 POCKET:** Y dimension for the opposite corner of the rectangular pocket that surrounds the island.

**CONRAD PCKT:** the value of the tangential radius in the corners of the rectangular pocket that surrounds the island.

**FIN CUT PCKT:** finish cut along the perimeter of the pocket. If 0 is input, there will be no finish cut.

**FEEDRATE:** the milling feedrate in in/min from .1 to 100, or mm/min from 5 to 2540

**FIN FEEDRATE:** the finish milling feedrate for both the island and pocket finish cuts

**TOOL #:** is the tool number you assign.

### 8.6.2 Rectangular Island

Press the RECT ISLAND softkey if you wish to machine a rectangular island.

Prompts for the RECT ISLAND:

**X1 ISLAND:** X dimension for one corner of the rectangular island.

**Y1 ISLAND:** Y dimension for one corner of the rectangular island.

**X3 ISLAND:** X dimension for the opposite corner of the island.

**Y3 ISLAND:** Y dimension for the opposite corner of the island.

**CONRAD ISL:** the value of the tangential radius in the corners of the island.

**DIRECTION:** is the milling direction, clockwise or counterclockwise

**FIN CUT ISL:** Finish cut for the Island. If 0 is input, there will be no finish cut.

**X1 POCKET:** X dimension for one corner of the rectangular pocket that surrounds the island.

**Y1 POCKET:** Y dimension for one corner of the rectangular pocket that surrounds the island.

**X3 POCKET:** X dimension for the opposite corner of the rectangular pocket that surrounds the island.

**Y3 POCKET:** Y dimension for the opposite corner of the rectangular pocket that surrounds the island.

**CONRAD PCKT:** the value of the tangential radius in the corners of the rectangular pocket that surrounds the island.

**FIN CUT PCKT:** finish cut along the perimeter of the pocket. If 0 is input, there will be no finish cut.

**FEEDRATE:** the milling feedrate in in/min from .1 to 100, or mm/min from 5 to 2540

**FIN FEEDRATE:** the finish milling feedrate for both the island and pocket finish cuts

**TOOL #:** is the tool number you assign.



### 8.6.3 Irregular Island

Press the IRREG ISLAND key if you wish to mill an island other than a rectangle or circle. The Irregular Island gives you the powerful Auto Geometry Engine to define a shape made up of straight lines and arcs.

The first screen in an Irregular Island event will define the beginning point and some of its general parameters. The last event of the irregular pocket must end at the same point as defined in the first event.

Prompts for the Irregular Island event:

**X BEGIN:** X dimension to the beginning of the island.

**Y BEGIN:** Y dimension to the beginning of the island.

**FIN CUT ISL:** Finish cut for the Island. If 0 is input, there will be no finish cut.

**X1 POCKET:** X dimension for one corner of the rectangular pocket that surrounds the island.

**Y1 POCKET:** Y dimension for one corner of the rectangular pocket that surrounds the island.

**X3 POCKET:** X dimension for the opposite corner of the rectangular pocket that surrounds the island.

**Y3 POCKET:** Y dimension for the opposite corner of the rectangular pocket that surrounds the island.

**CONRAD PCKT:** the value of the tangential radius in the corners of the rectangular pocket that surrounds the island.

**FIN CUT PCKT:** finish cut along the perimeter of the pocket. If 0 is input, there will be no finish cut.

**FEEDRATE:** the milling feedrate in in/min from .1 to 100, or mm/min from 5 to 2540

**FIN FEEDRATE:** the finish milling feedrate for both the island and pocket finish cuts

**TOOL #:** is the tool number you assign.

When the initial screen is complete, you will define the perimeter of the island with a series of A.G.E. Mills and A.G.E. Arcs. Programming with the Auto Geometry Engine is explained in Section 10.0.

## 8.7 PROFILE Events

This event allows you to mill around the outside or inside of a circular or rectangular frame or an irregular profile. The irregular profile may be closed or open.

When the irregular profile event is started the ProtoTRAK SM CNC will automatically initiate the powerful Auto Geometry Engine. See Section 10.0 for programming with A.G.E.

### 8.7.1 Circle profile

Press the **CIRCLE** soft key if you wish to mill a circular frame.

Prompts in the Circle Profile event:

**X Center:** is the X dimension to the center of the circle

**Y Center:** is the Y dimension to the center of the circle

**Radius:** is the finish radius of the circle

**Direction:** is the clockwise (input 1), or counterclockwise (input 2) direction for milling

**Tool Offset:** is the selection of the tool offset to the right (input 1), offset to the left (input 2), or tool center--no offset (input 0) relative to the programmed edge and direction of the cutter movement

**Fin Cut:** is the width of the finish cut. If 0 is input, there will be no finish cut

**Feedrate:** is the milling feedrate in in/min from .1 to 100, or mm/min from 5 to 2540

**Finish Feedrate:** is the milling feedrate for the finish cut

**Tool #:** is the tool number you assign

### 8.7.2 Rectangular Profile

Press the **RECTANGLE** soft key if you wish to mill a rectangular frame (all corners are 90° right angles).

Prompts for the rectangular profile:

**X1:** is the X dimension to any corner

**Y1:** is the Y dimension to the same corner as X1

**X3:** is the X dimension to the corner opposite X1; incremental is from X1

**Y3:** is the Y dimension to the same corner as X3; incremental is from Y1

**Conrad:** is the value of the tangential radius in each corner

**Direction:** is the clockwise (input 1), or counterclockwise (input 2) direction for milling

**Tool Offset:** is the selection of the tool offset to the right (input 1), offset to the left (input 2), or tool center--no offset (input 0) relative to the programmed edge and direction of the cutter movement

**Fin Cut:** is the width of the finish cut. If 0 is input, there will be no finish cut

**Feedrate:** is the milling feedrate in in/min from .1 to 100, or mm/min from 5 to 2540

**Fin Feedrate:** is the milling feedrate for the finish cut (if programmed).

**Tool #:** is the tool number you assign

### 8.7.3 Irregular Profile

Press the **IRREG PROFILE** soft key if you wish to mill a profile other than a rectangle or circle. The Irregular Profile event gives you the powerful Auto Geometry Engine to define a shape made up of straight lines (Mills) and arcs.

The Irregular Profile is a series of events that are programmed to machine continuously. The first event of the series will be called an IRR PROFILE and it will define the beginning point of the profile and other information that applies to the entire profile.

**X Begin:** is the X dimension of the beginning of the profile

**Y Begin:** is the Y dimension of the beginning of the profile

**Tool Offset:** is the selection of the tool offset to right (input 1), offset to left (input 2), or tool center--no offset (input 0) relative to the programmed edge and direction of tool cutter movement

**Feedrate:** is the milling feedrate in in/min from .1 to 100, or mm/min from 5 to 2540

**Fin Cut:** is the width of the finish cut. If 0 is input there will be no finish cut

**Fin Feedrate:** is the finish cut milling feedrate in in/min from .1 to 100, or mm/min from 5 to 2540

**Tool #:** is the tool number you assign

When the initial Irregular Profile screen is complete, the rest of the profile is programmed using A.G.E. Mill and A.G.E. Arc events. Programming with the Auto Geometry Engine is explained in Section 10.0.

## 8.8 Engrave Event

The Engrave Event allows you to machine numbers, letters and special characters as part of a part program. See figure 8.8 below for the letters and special characters that are available in the Engrave Event.

When programming with the Engrave Event, the ProtoTRAK will construct a box to contain the text you define. This box is oriented along the X axis like the text in this sentence, and you may program up to 40 characters per event (although you will only be able to see 20 characters on the prompts screen). To machine text in a direction other than the X axis, simply use multiple Engrave Events and place the lower left corner of the box wherever you would like. The numbers and letters you program will always have a standard orientation (like the letters on this page) – you cannot program tilted or inverted letters with the Engrave Event. The letters are of the font shown in the figure and all capitals.

### Prompts for the Engrave Event

First, define the lower left corner of the box that will contain your text:

**X BEGIN:** The X coordinate of where you want your text to begin

**Y BEGIN:** The Y coordinate of where you want your text to begin

**HEIGHT:** The height of your text. Each character varies in width; the set height of the character will change the width in order to keep the overall size of the character proportional.

**TEXT:** The text to be milled. When you get to this prompt, the Alpha keys will automatically pop up to allow you to enter the text. Once you have finished entering text, you must press End (F8) and then any of the SET keys to successfully enter your text into the event. The alpha keys will appear automatically if the text field is blank. If you have already entered text but wish to make a change, you will see a blue question mark appear on the lower left corner of the screen when you scroll to this field, press the Help button and the alpha keys will appear.

**FEEDRATE:** The feedrate of XYZ along the path of the text

**Tool #:** is the tool number you assign

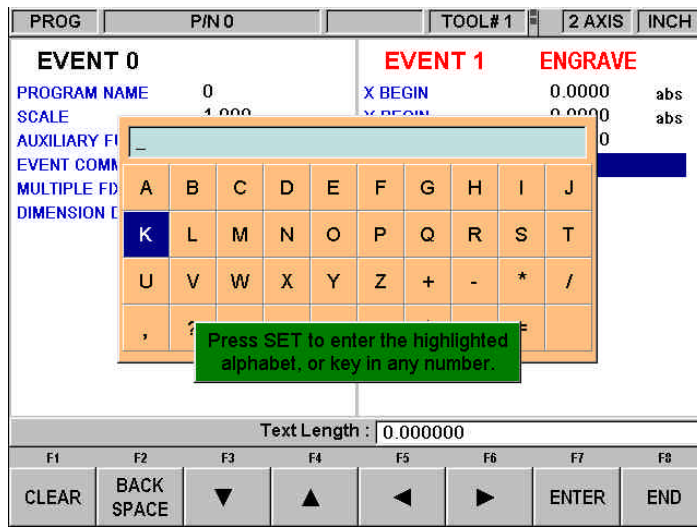

**FIGURE 8.8** The above figure shows the text and special characters available for the Engrave event. Notice the field that is labeled “Text Length”. This field will display the total length of your programmed text and will update as you enter each character.

## 8.9 Subroutine Events

The Subroutine Events are used for manipulating previously programmed geometry within the XY plane.

The Subroutine Event is divided into three options: Repeat, Mirror, and Rotate.

Repeat and Rotate may be connective. As long as the rules of connectivity are satisfied (see Section 5.9), the ProtoTRAK SM CNC will continue milling between preceding and subsequent events.

**REPEAT** allows you to repeat an event or a group of events up to 99 times with an offset in X and/or Y. This can be useful for drilling a series of evenly spaced holes, duplicating some machined shapes, or even repeating an entire program with an offset for a second fixture.

Repeat events may be “nested.” That is, you can repeat a repeat event, of a repeat event, of some programmed event(s). One new tool number may be assigned for each Repeat Event.

**MIRROR** is used for parts that have symmetrical patterns or mirror image patterns. In addition to specifying the events to be repeated, you must also indicate the axis or axes (X or Y or XY are allowed) that the reflection is mirrored across. In addition, you must specify the offset from absolute zero to the line of reflection. You may not mirror another mirror event, or mirror a rotate event. Consider the figure:

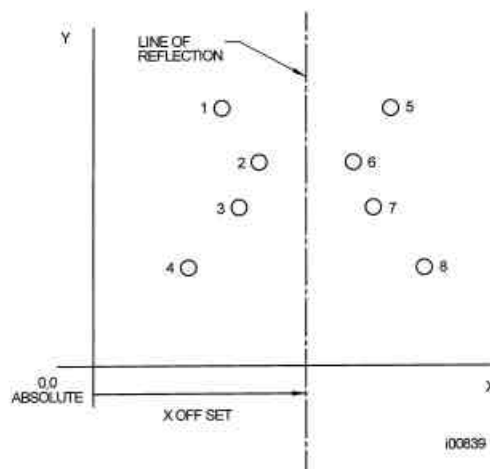

**FIGURE 8.9.1** Holes 1-4 are mirrored across the Y axis to 5-8, respectively, about a line X OFFSET from X=absolute 0

**ROTATE** is used for polar rotation of parts that have a rotational symmetry around some point in the XY plane. In addition to specifying the events to be repeated, you must also indicate the absolute X and Y position of the center of rotation, the angle of rotation (measured counterclockwise as positive; and clockwise as negative), and the number of times the specified events are to be rotated and repeated. You may not rotate another rotate event, or rotate a mirror event. Consider the figure below:

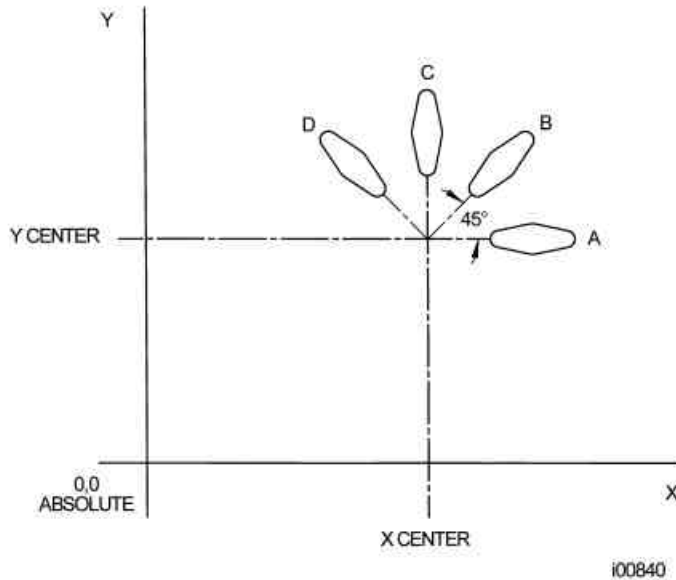

**FIGURE 8.9.2** Shape A programmed with 4 MILL events and Conrads. Using ROTATE, these 4 events are rotated through a 45 degree angle about a point offset from absolute zero by X Center and Y Center dimensions. A is rotated 3 times to produce shape B, C, and D

Press the **SUBROUTINE** (SUB) soft key to call up the Repeat, Mirror, and Rotate options.

### 8.9.1 Repeat

Press the **REPEAT** soft key.

Where:

**First Event #:** is the event number of the first event to be repeated

**Last Event #:** is the event number of the last event to be repeated; if only one event is to be repeated, the Last Event # is the same as the First Event #

**X Offset:** is the incremental X offset from event to be repeated

**Y Offset:** is the incremental Y offset from event to be repeated

**# Repeats:** is the number of times events are to be repeated up to 99

**% Feed:** the percentage of the feeds programmed in the repeated events. 100% is assumed

**Tool #:** is the tool number you assign

### 8.9.2 Mirror

Press the **MIRROR** soft key.

**First Event #:** is the event number of the first event to be mirrored

**Last Event #:** is the event number of the last event to be mirrored; if only one event is to be mirrored, the last event is the same as the first.

**Cutting Order:** input 1 to cut from the lowest mirrored event to the highest (forward) and 2 to machine from the highest mirrored event to the lowest (backward). This way you can keep all the machine motion in a consistent direction as it moves from the original shape to the mirrored shape and keep all cutting either climb or conventional.

**Mirror Axis:** is the selection of the axis or axes to be mirrored (input X or Y or XY, SET)

**X Offset:** is the distance from Y absolute 0 to the Y-axis line of reflection

**Y Offset:** is the distance from X absolute 0 to the X-axis line of reflection

### 8.9.3 Rotate

Press the **ROTATE** soft key.

**First Event #:** is the event number of the first event to be rotated

**Last Event #:** is the event number of the last event to be rotated; if only one event is to be rotated, the last event is the same as the first

**X Center:** is the X absolute position of the center of rotation

**Y Center:** is the Y absolute position of the center of rotation

**Angle:** is the angle of rotation of the repeated events (positive is counterclockwise; negative is clockwise)

**# Repeats:** is the number of times events are to be rotated up to 99

## 8.10 COPY Events

Copy Events are programmed exactly like Subroutine Events. The only difference is that in Copy the events are rewritten into subsequent events. If, for example, in Event 11 you Copy Repeated Events 6, 7, 8, 9, 10 with 2 repeats, Events 6-10 would be copied with the input offsets into Events 11-15, and recopied into 16-20.

Copy Events may be Repeat, Mirror, or Rotate.

Copy is very useful. With copy you can:

- Edit the events that are being repeated, mirrored or rotated without changing the original events.
- Connect so that the quill will not move up to the Z Rapid position, and back down unnecessarily. However, to be connective, you must be certain that the X, Y, Z begin of the first event, once offset or rotated, coincides with the X, Y, Z end of the last event.
- Program an event parallel to X or Y (where the geometry is the easiest to describe), rotate it to the desired position, and then delete the original.
- Use the Clipboard to paste previously stored events from another program into the current program. After you press the Clipboard key, you will enter the offset from the previous program's absolute zero to the current program's absolute zero (see figure below). For information about putting events into the clipboard, see Section 11.4.

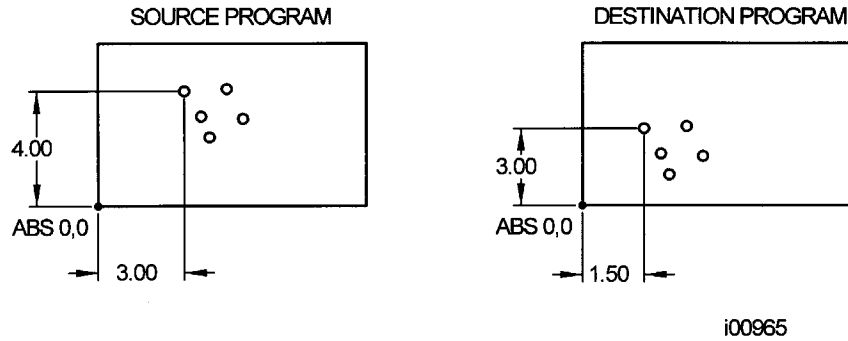

i00965

**Figure 8.10** In the above example, the offset that puts the group of holes in the desired location is  $X=-1.50$  and  $Y=-1.00$ .

## 8.11 Finishing Teach Events

Teach events are either POSN/DRILL or MILL events that are originated in the DRO Mode (see Section 6.6).

The Teach events that are started in the DRO Mode must be finished in the Program Mode before running. Teach events are of these different types:

**TEACH POSN/DRILL** - See Section 8.1 for a description of Position/Drill event prompts.

**TEACH MILL** - a straight line that specifies the beginning and the end. When TEACH MILL events are defined using the CONT MILL softkey, the prompts for information that cannot change will be suppressed. See Section 8.3 for a description of Mill event prompts.

When a Teach event is unfinished, the words NOT OK will appear next to the event type. Once the prompts are completed, the words NOT OK and Teach will disappear. The event will become a normal POSN/DRILL or MILL event.

## 9.0 Three-Axis CNC Program Events

This section describes the program events and prompts that are available in three-axis programming. If your ProtoTRAK SM CNC model is configured for two-axis programming only, you should skip this section.

If you are interested in both two- and three-axis programming, you will encounter a lot of redundancy between this and the previous section, Two-Axis Program Events, as many of the events and prompts are similar. While the redundancy itself is irritating, it does have the benefit of describing all the events completely without forcing you to look in different places.

Events are fully defined pieces of geometry. By programming events, you tell the ProtoTRAK SM CNC what geometry you want to end up with; it figures the tool path for you from your answers to the prompts and the tool information you give it in the Set-Up Mode.

### 9.1 POSN: Position Events

This event type positions the table and quill at a specified position. The positioning is always at rapid speed (modified by feedrate override) and in the most direct path possible from the previous location. The most common use of the position event is to move the tool around an obstacle such as a clamp. For this reason, Z and X - Y motion will not occur simultaneously. First, the Z (head) will move to the higher of the Z rapid position of the current and next event, then the X (table) and Y (saddle) will move at to the programmed position.

To program a Position event press the **POSN** soft key.

Prompts for the Position event:

**X END** is the X dimension to the position

**Y END** is the Y dimension to the position

**Z Rapid** is the Z dimension to the position

**Tool #** is the tool number you assign. SET will use the tool number of the previous event.

### 9.2 DRILL Events

This event positions the table to the specified X and Y position, moves the HEAD at rapid to the Z RAPID location, feeds the quill to the Z END location, and rapids back to Z RAPID for drill, and feeds back for bore.

Press the **DRILL** soft key.

Prompts for the drill event:

**Drill=1, Bore=2:** selects whether the hole is to be drilled or bored

**X:** is the X dimension to the hole

**Y:** is the Y dimension to the hole

**Z Rapid:** is the Z dimension to transition from rapid to feed

**Z End:** is the bottom of the hole

**# Pecks:** is the number of tool withdrawal cycles (each cycle drills and then retracts to the Z Rapid position). The factory setting is for each peck to be successively smaller, taking the largest cuts at the beginning and the smallest at the end. When the highlight is on this prompt, you may change this setting by pressing the HELP key. This will take you to a screen where you may choose to have the same amount of material taken per peck.



**Z Feedrate:** is the drilling feedrate

**Tool #:** is the tool number you assign

### 9.3 BOLT HOLE Events

This event allows you to program a bolt hole pattern without needing to compute and program the position of each hole.

Prompts for the Bolt Hole event:

**Drill=1, Bore=2:** selects whether the hole is to be drilled or bored

**# Holes:** is the number of holes in the bolt hole pattern

**X Center:** is the X dimension to the center of the hole pattern

**Y Center:** is the Y dimension to the center of the hole pattern

**Z Rapid:** is the Z dimension to transition from rapid to feed

**Z End:** is the bottom of the hole

**Radius:** is the radius of the hole pattern from the center to the center of the holes

**Angle:** is the angle from the positive X axes (that is, 3 o'clock) to any hole; positive angle is measured counterclockwise from 0.000 to 359.999 degrees, negative angles measured clockwise.

**# Pecks:** is the number of tool withdrawal cycles (each cycle drills progressively less and retracts to the Z Rapid position). The factory setting is for each peck to be successively smaller, taking the largest cuts at the beginning and the smallest at the end. When the highlight is on this prompt, you may change this setting by pressing the HELP key. This will take you to a screen where you may choose to have the same amount of material taken per peck.

**Z Feedrate:** is the drilling feedrate

**Tool #:** is the tool number you assign

### 9.4 MILL Events

This event allows you to mill in a straight line from any one XYZ point to another, including at a diagonal in space. It may be programmed with a CONRAD if it is connective with the next event (this next event must lie in the same plane as the Mill event).

Prompts for the Mill event:

**X Begin:** is the X dimension to the beginning of the mill cut

**Y Begin:** is the Y dimension to the beginning of the mill cut

**Z Rapid:** is the Z dimension to transition from rapid to feed

**Z Begin:** is the Z dimension to the beginning of the mill cut

**X End:** is the X dimension to the end of the mill cut; incremental is X Begin

**Y End:** is the Y dimension to the end of the mill cut; incremental is Y Begin

**Z End:** is the Z dimension to the end of the mill cut; incremental is Z Begin

**Conrad:** is the dimension of a tangential radius to the next event (that must lie in the same plane for part geometry programming)

**Tool Offset:** is the selection of the tool offset to right (input 1), offset to left (input 2), or tool center--no offset (input 0) relative to the programmed edge and direction of tool cutter movement and as projected in the XY plane.

**Z Feedrate:** is the Z feedrate from Z Rapid to Z begin

**XYZ Feedrate:** is the milling feedrate from Begin to End in in/min from .1 to 100, or mm/min from 5 to 2540

**Tool #:** is the tool number you assign

## 9.5 ARC Events

This event allows you to mill with circular contouring any arc (fraction of a circle) that lies in the XY plane or a vertical plane (see Section 5.10). Vertical plane arcs are also limited to those that are entirely concave or convex (in other words, if you think of the arc lying on the surface of the earth, then it can't cross the equator).

In ARC events when X Center, Y Center, and Z Center are programmed incrementally, they are referenced from X End, Y End, and Z End respectively. An ARC event may be programmed with a CONRAD if it is connective with the next event (this next event must lie in the same plane as the Arc event).

*Note: When an arc is a 180° arc, there are several paths that all have the same beginning, ending, and center locations. To illustrate, Imagine that if you were on the earth's equator and you wanted to get to the other side of the earth you could go clockwise or counterclockwise around the equator, or you could go up over the north pole, or down under the south pole. The ProtoTRAK SM CNC will automatically assume that all 180° arcs that have the same beginning, ending and center dimensions for Z, lie in the XY plane. If you want a 180° arc in a vertical plane, you must program two 90° arcs or some equivalent.*

Prompts for the Arc event:

**X Begin:** is the X dimension to the beginning of the arc cut

**Y Begin:** is the Y dimension to the beginning of the arc cut

**Z Rapid:** is the Z dimension to transition from rapid to feed

**Z Begin:** is the Z dimension to the beginning of the arc cut

**X End:** is the X dimension to the end of the arc cut; incremental is from X Begin

**Y End:** is the Y dimension to the end of the arc cut; incremental is from Y Begin

**Z End:** is the Z dimension to the end of the arc cut; incremental is from Z Begin

**X Center:** is the X dimension to the center of the arc; incremental is from X End

**Y Center:** is the Y dimension to the center of the arc; incremental is from Y End

**Z Center:** is the Z dimension to the center of the arc; incremental is from Z End

**Conrad:** is the dimension of a tangential radius to the next event (which must lie in the same plane)

**Direction:** is the clockwise (input 1), or counterclockwise (input 2) direction of the arc as viewed looking down for an arc in the XY plane, looking from the front for a vertical plane, or looking from the right for a vertical YZ plane

**Tool Offset:** is the selection of the tool offset to right (input 1), offset to left (input 2), or tool center--no offset (input 0) relative to the programmed edge and direction of tool cutter movement and as projected in the XY plane

**Z Feedrate:** is the Z feedrate from Z Rapid to Z Begin

**XYZ Feedrate:** is the milling feedrate from Begin to End in in/min from .1 to 100, or mm/min from 5 to 2540

**Tool #:** is the tool number you assign

## 9.6 POCKET Event

This event selection gives you a choice between, circle pocket, rectangular pocket and irregular pocket within the XY plane.

Pockets include machining the circumference, as well as all the material inside the circumference of the programmed shape. If a finished cut is programmed, it will be made at the completion of the final pass. The cutter will arc in and arc out of the finish cut and position itself the finish cut dimension away from the part before moving the tool out of the part.

The factory setting for tool stepover while machining a pocket is 70%. This may be changed. When you first enter the pocket event, the blue ? will appear next to the help key. Pressing Help will give you the choice of entering a new tool stepover percentage. The value you enter here will remain the same until you change it again.

### 9.6.1 Circular Pocket

Press the **CIRCLE PCKT** soft key if you wish to mill a circular pocket.

Prompts for the circle pocket:

**X Center:** is the X dimension to the center of the circle

**Y Center:** is the Y dimension to the center of the circle

**Z Rapid:** is the Z dimension to transition from rapid to feed

**Z End:** is the Z dimension at the bottom of the pocket; incremental is from the previous event

**Radius:** is the finish radius of the circle

**Direction:** is the clockwise (input 1), or counterclockwise (input 2) direction for milling

**# Passes:** number of cycles to machine to the final depth spaced equally from Z Rapid to Z End (hint: keep Z Rapid small)

**Entry mode:** choose between a zigzag ramp and a plunge. The plunge will machine straight down Z to the appropriate Z depth. The zigzag ramp will move in a zigzag pattern to depth. See Section 9.6.5 for more information about the zigzag ramp.

**Fin Cut:** is the width of the finish cut. If 0 is input, there will be no finish cut. See Section 9.6.7 for a bottom finish cut.

**Z Feedrate:** is the Z feedrate from Z rapid to Z end

**XYZ Feedrate:** is the milling feedrate in in/min from .1 to 100, or mm/min from 5 to 2540

**Fin Feedrate:** is the milling feedrate for the finish cut

**Tool #:** is the tool number you assign

### 9.6.2 Rectangular Pocket

Press **RECTANGLE** soft key if you wish to mill a rectangular pocket (all corners are 90° right angles and the sides are parallel to the X and Y axes).

The prompts for the rectangular pocket:

**X1:** is the X dimension to any corner

**Y1:** is the Y dimension to the same corner as X1

**X3:** is the X dimension to the corner opposite X1; incremental is from X1

**Y3:** is the Y dimension to the same corner as X3; incremental is from Y1

**Z Rapid:** is the Z dimension to transition from rapid to feed

**Z End:** is the Z dimension at the bottom of the pocket; incremental is from the previous event

**Conrad:** is the value of the tangential radius in each corner

**Direction:** is the clockwise (input 1), or counterclockwise (input 2) direction for milling

**# Passes:** is the number of cycles to machine to the final depth spaced equally from Z Rapid to Z End (hint: keep Z Rapid small)

**Entry mode:** choose between a zigzag ramp and a plunge. The plunge will machine straight down Z to the appropriate Z depth. The zigzag ramp will move in a zigzag pattern to depth. See Section 9.6.5 for more information about the zigzag ramp.

**Fin Cut:** is the width of the finish cut. If 0 is input there will be no finish cut

**Z Feedrate:** is the Z feedrate from Z rapid to Z end. See Section 9.6.7 for a bottom finish cut.

**XYZ Feedrate:** is the milling feedrate in in/min from .1 to 100, or mm/min from 5 to 2540

**Fin Feedrate:** is the milling feedrate for the finish cut

**Tool #:** is the tool number you assign

### 9.6.3 Irregular Pocket

Press the **IRREG PCKT** soft key if you wish to mill a pocket other than a rectangle or circle. The Irregular Pocket event gives you the powerful Auto Geometry Engine to define a shape made up of straight lines (Mills) and arcs.

The first screen in an irregular pocket event will define the beginning point and some of its general parameters. The last event of the irregular pocket must end at the same point as defined in the first event.

**X Begin:** is the X dimension of the beginning of the pocket

**Y Begin:** is the Y dimension of the beginning of the pocket

**Z Rapid:** is the Z dimension to transition from rapid to feed

**Z End:** is the Z dimension of the depth of the pocket.

**# Passes:** is the number of cycles to machine to the final depth spaced equally from Z rapid to Z end (hint: keep Z Rapid small)

**Entry mode:** choose between a zigzag ramp and a plunge. The plunge will machine straight down Z to the appropriate Z depth. The zigzag ramp will move in a zigzag pattern to depth. See Section 9.6.5 for more information about the zigzag ramp.

**Z Feedrate:** is the Z feedrate from Z rapid to Z end

**XYZ Feedrate:** is the milling feedrate in in/min from .1 to 100, or mm/min from 5 to 2540

**Fin Cut:** is the width of the finish cut. If 0 is input there will be no finish cut. See Section 9.6.7 for a bottom finish cut.

**Fin Feedrate:** is the finish cut milling feedrate in in/min from .1 to 100, or mm/min from 5 to 2540

**Tool #:** is the tool number you assign

When the initial screen is complete, you will define the perimeter of the pocket with a series of A.G.E. Mills and A.G.E. Arcs. Programming with the Auto Geometry Engine is explained in Section 10.0.

No islands may exist in an irregular pocket.

#### 9.6.4 Tool Path in Pocket Events

In Program Run, the pocket path will be either the plunge or zigzag cuts to Z depth along either the X or Y, followed by the required number of cuts to clear out the interior material, and then the rough cut along the inside of the perimeter. This will be repeated for each pass and then followed by a finish pass (if FIN CUT was not zero) along the inside of the perimeter at the Finish Feedrate and final depth. If a bottom finish cut was programmed, it will be machined before the perimeter finish cut.

Whether the cuts to clear the interior material of the irregular pocket are along the X or Y-axis depends on if there are hidden areas of the pocket. The ProtoTRAK SM CNC always looks to cut along the X-axis first. If there are areas that are hidden to the X-axis, it will machine along the Y-axis. If there are hidden areas that cannot be machined continuously in the X or Y-axis, the tool will return to Z retract and then reposition to machine the hidden area.

#### 9.6.5 Zigzag Z Depth Cuts

In programming pocket events, you have a choice to program the cuts to Z depth either as a plunge or a zigzag ramp. For rectangular and circular pockets, the tool will start in the center of the pocket. For irregular pockets, since there is no center defined, the tool will start in the lower left corner of the pocket. The direction of the ramp will be the same as the initial direction in either X or Y, depending on how the pocket is to be cut.

The tool will zigzag back and forth along the X or Y over a length of one tool radius while at the same time moving in the Z direction. When it travels one tool radius along this direction, it will have traveled a distance of ten percent of the tool diameter along the Z. This works out to roughly ramping into the part at an angle of 11 degrees.

In order to use a zigzag ramp, the X or Y move must be larger than the diameter of the tool plus the radius of the tool, minus the finish cut of the pocket. The formula is:

$$\textit{the pocket x or y move} > \textit{tool diameter} + \textit{tool radius} - \textit{fin cut}$$

If the tool is too large for the zigzag ramp, the ProtoTRAK SM CNC will give an error message during program run and will then default to plunge. This will occur for each pass of the pocket depth.

#### 9.6.6 Conrad in Pocket Events

A conrad may be added to the last event of an Irregular Pocket. The conrad will be inserted between the end of the last event and the beginning of the next event.

### 9.6.7 Bottom Finish Cut

The standard finish cut is along the walls of the part, but you may have the ProtoTRAK machine a finish cut along the bottom as well. When the highlight is on the Fin Cut prompt, the blue ? appears next to the Help key. Pressing help gives you the ability to choose a Finish cut in Z. You can remove the bottom finish cut by placing the highlight on the Fin Cut prompt and pressing Help again. When you select Yes to the bottom finish cut, the following prompt will appear:

**Z FIN CUT:** the finish cut at the bottom.

## 9.7 Islands

Within the Pocket event choices, you may also select a circular, rectangular or irregular island. An island is a shape that is left standing when the surrounding material is removed. The ProtoTRAK gives you the ability to machine almost any shape as an island within a rectangular pocket. Both the shape of the island and the dimension of the surrounding pocket are defined within the island event.

The tool path for machining the island event is that the tool will first plunge or ramp into the material next to the island, offset by the programmed finish cut, to the depth of the first pass. The tool will machine the perimeter of the island, offset by the island finish cut. Then the tool will machine the material in the pocket in a spiral path, moving away from the island in the programmed clockwise or counterclockwise direction. It will continue this outward spiral motion until it encounters the programmed rectangular perimeter (or pocket). It will then follow the perimeter, offset by the pocket finish cut.

It will proceed in this manner through the number of programmed passes. On the final pass, it will machine the island finish cut, then the pocket finish cut. If a Z finish cut is programmed, it will do this in the same spiral pattern as the roughing passes between machining the island and pocket finish cuts. The tool will ramp away from the finish cut by the amount of the finish cut before it rises out of the part.

### 9.7.1 Circular Island

Press the Circle Island soft key if you wish to mill a circular island.

Prompts for the Circle Pocket:

**X CENTER:** is the dimension of the center of the Island

**Y CENTER:** is the dimension of the center of the Island

**Z RAPID:** is the Z dimension of the transition from rapid to feed

**Z END:** is the Z dimension at the bottom of the pocket; incremental is from the previous event

**RADIUS:** is the finish radius of the Island

**DIRECTION:** is the milling direction, clockwise or counterclockwise

**#PASSES:** the number of roughing passes to the depth

**ENTRY MODE:** choose between zigzag ramp and plunge. The plunge will machine straight down Z to the appropriate Z depth. The zigzag ramp will move in a zigzag pattern to depth. See the previous section for more information about the zigzag ramp.

**FIN CUT ISL:** Finish cut for the Island. If 0 is input, there will be no finish cut. See the previous section for a bottom finish cut.

**X1 POCKET:** X dimension for one corner of the rectangular pocket that surrounds the island.

**Y1 POCKET:** Y dimension for one corner of the rectangular pocket that surrounds the island.

**X3 POCKET:** X dimension for the opposite corner of the rectangular pocket that surrounds the island.

**Y3 POCKET:** Y dimension for the opposite corner of the rectangular pocket that surrounds the island.

**CONRAD PCKT:** the value of the tangential radius in the corners of the rectangular pocket that surrounds the island.

**FIN CUT PCKT:** finish cut along the perimeter of the pocket. If 0 is input, there will be no finish cut. See the previous section for a bottom finish cut.

**Z FEEDRATE:** is the Z feedrate from Z rapid to Z end.

**XYZ FEEDRATE:** the milling feedrate in in/min from .1 to 100, or mm/min from 5 to 2540

**FIN FEEDRATE:** the finish milling feedrate for both the island and pocket finish cuts

**TOOL #:** is the tool number you assign.

## 9.7.2 Rectangular Island

Press the RECT ISLAND softkey if you wish to machine a rectangular island.

Prompts for the RECT ISLAND:

**X1 ISLAND:** X dimension for one corner of the rectangular island.

**Y1 ISLAND:** Y dimension for one corner of the rectangular island.

**X3 ISLAND:** X dimension for the opposite corner of the island.

**Y3 ISLAND:** Y dimension for the opposite corner of the island.

**Z RAPID:** is the Z dimension of the transition from rapid to feed

**Z END:** is the Z dimension at the bottom of the pocket; incremental is from the previous event

**CONRAD ISL:** the value of the tangential radius in the corners of the island.

**DIRECTION:** is the milling direction, clockwise or counterclockwise

**#PASSES:** the number of roughing passes to the depth

**ENTRY MODE:** choose between zigzag ramp and plunge. The plunge will machine straight down Z to the appropriate Z depth. The zigzag ramp will move in a zigzag pattern to depth. See the previous section for more information about the zigzag ramp.

**FIN CUT ISL:** Finish cut for the Island. If 0 is input, there will be no finish cut. See the previous section for a bottom finish cut.

**X1 POCKET:** X dimension for one corner of the rectangular pocket that surrounds the island.

**Y1 POCKET:** Y dimension for one corner of the rectangular pocket that surrounds the island.

**X3 POCKET:** X dimension for the opposite corner of the rectangular pocket that surrounds the island.

**Y3 POCKET:** Y dimension for the opposite corner of the rectangular pocket that surrounds the island.

**CONRAD PCKT:** the value of the tangential radius in the corners of the rectangular pocket that surrounds the island.

**FIN CUT PCKT:** finish cut along the perimeter of the pocket. If 0 is input, there will be no finish cut. See the previous section for a bottom finish cut.

**Z FEEDRATE:** is the Z feedrate from Z rapid to Z end.

**XYZ FEEDRATE:** the milling feedrate in in/min from .1 to 100, or mm/min from 5 to 2540

**FIN FEEDRATE:** the finish milling feedrate for both the island and pocket finish cuts

**TOOL #:** is the tool number you assign.

### 9.7.3 Irregular Island

Press the IRREG ISLAND key if you wish to mill an island other than a rectangle or circle. The Irregular Island gives you the powerful Auto Geometry Engine to define a shape made up of straight lines and arcs.

The first screen in an Irregular Island event will define the beginning point and some of its general parameters. The last event of the irregular pocket must end at the same point as defined in the first event.

Prompts for the Irregular Island event:

**X BEGIN:** X dimension to the beginning of the island.

**Y BEGIN:** Y dimension to the beginning of the island.

**Z RAPID:** is the Z dimension of the transition from rapid to feed

**Z END:** is the Z dimension at the bottom of the pocket; incremental is from the previous event

**#PASSES:** the number of roughing passes to the depth

**ENTRY MODE:** choose between zigzag ramp and plunge. The plunge will machine straight down Z to the appropriate Z depth. The zigzag ramp will move in a zigzag pattern to depth. See the previous section for more information about the zigzag ramp.

**FIN CUT ISL:** Finish cut for the Island. If 0 is input, there will be no finish cut. See the previous section for a bottom finish cut.

**X1 POCKET:** X dimension for one corner of the rectangular pocket that surrounds the island.

**Y1 POCKET:** Y dimension for one corner of the rectangular pocket that surrounds the island.

**X3 POCKET:** X dimension for the opposite corner of the rectangular pocket that surrounds the island.

**Y3 POCKET:** Y dimension for the opposite corner of the rectangular pocket that surrounds the island.

**CONRAD PCKT:** the value of the tangential radius in the corners of the rectangular pocket that surrounds the island.

**FIN CUT PCKT:** finish cut along the perimeter of the pocket. If 0 is input, there will be no finish cut. See the previous section for a bottom finish cut.

**Z FEEDRATE:** is the Z feedrate from Z rapid to Z end.

**XYZ FEEDRATE:** the milling feedrate in in/min from .1 to 100, or mm/min from 5 to 2540

**FIN FEEDRATE:** the finish milling feedrate for both the island and pocket finish cuts



**TOOL #:** is the tool number you assign.

When the initial screen is complete, you will define the perimeter of the island with a series of A.G.E. Mills and A.G.E. Arcs. Programming with the Auto Geometry Engine is explained in Section 10.0.

## 9.8 PROFILE Events

This event allows you to mill around the outside or inside of a circular or rectangular frame or an irregular profile. The irregular profile may be closed or open. All profiles are limited to the XY plane.

When the irregular profile event is started the ProtoTRAK SM CNC will automatically initiate the powerful Auto Geometry Engine. See Section 10.0 for programming with A.G.E.

### 9.8.1 Circle profile

Press the **CIRCLE** soft key if you wish to mill a circular frame.

Prompts in the Circle Profile event:

**X Center:** is the X dimension to the center of the circle

**Y Center:** is the Y dimension to the center of the circle

**Z Rapid:** is the Z dimension to transition from rapid to feed

**Z End:** is the Z dimension to the bottom of the frame; incremental is from the previous event

**Radius:** is the finish radius of the circle

**Direction:** is the clockwise (input 1), or counterclockwise (input 2) direction for milling

**Tool Offset:** is the selection of the tool offset to the right (input 1), offset to the left (input 2), or tool center--no offset (input 0) relative to the programmed edge and direction of the cutter movement

**# Passes:** is the number of cycles to machine to the final depth spaced equally from Z Rapid to Z End (hint: keep Z Rapid small)

**Fin Cut:** is the width of the finish cut. If 0 is input, there will be no finish cut

**Z Feedrate:** is the Z feedrate from Z rapid to Z end

**XYZ Feedrate:** is the milling feedrate in in/min from .1 to 100, or mm/min from 5 to 2540

**Finish Feedrate:** is the milling feedrate for the finish cut

**Tool #:** is the tool number you assign

### 9.8.2 Rectangular Profile

Press the **RECTANGLE** soft key if you wish to mill a rectangular frame (all corners are 90° right angles).

Prompts for the rectangular profile:

**X1:** is the X dimension to any corner

**Y1:** is the Y dimension to the same corner as X1

**X3:** is the X dimension to the corner opposite X1; incremental is from X1

**Y3:** is the Y dimension to the same corner as X3; incremental is from Y1

**Z Rapid:** is the Z dimension to transition from rapid to feed

**Z End:** is the Z dimension at the bottom of the frame; incremental is from the previous event

**Conrad:** is the value of the tangential radius in each corner

**Direction:** is the clockwise (input 1), or counterclockwise (input 2) direction for milling

**Tool Offset:** is the selection of the tool offset to the right (input 1), offset to the left (input 2), or tool center--no offset (input 0) relative to the programmed edge and direction of the cutter movement

**# Passes:** is the number of cycles to machine to the final depth spaced equally from Z Rapid to Z End (hint: keep Z Rapid small)

**Fin Cut:** is the width of the finish cut. If 0 is input, there will be no finish cut

**Z Feedrate:** is the Z feedrate from Z rapid to Z end

**XYZ Feedrate:** is the milling feedrate in in/min from .1 to 100, or mm/min from 5 to 2540

**Fin Feedrate:** is the milling feedrate for the finish cut (if programmed).

**Tool #:** is the tool number you assign

### 9.8.3 Irregular Profile

Press the **IRREG PROFILE** soft key if you wish to mill a profile other than a rectangle or circle. The Irregular Profile event gives you the powerful Auto Geometry Engine to define a shape made up of straight lines (Mills) and arcs.

The Irregular Profile is a series of events that are programmed to machine continuously. The first event of the series will be called an IRR PROFILE and it will define the beginning point of the profile and other information that applies to the entire profile.

**X Begin:** is the X dimension of the beginning of the profile

**Y Begin:** is the Y dimension of the beginning of the profile

**Z Rapid:** is the Z dimension to transition from rapid to feed

**Z End:** is the Z dimension of the depth of the profile

**Tool Offset:** is the selection of the tool offset to right (input 1), offset to left (input 2), or tool center--no offset (input 0) relative to the programmed edge and direction of tool cutter movement

**# Passes:** is the number of cycles to machine to the final depth spaced equally from Z rapid to Z end (hint: keep Z Rapid small)

**Z Feedrate:** is the Z feedrate from Z rapid to Z end

**XYZ Feedrate:** is the milling feedrate in in/min from .1 to 100, or mm/min from 5 to 2540

**Fin Cut:** is the width of the finish cut. If 0 is input there will be no finish cut

**Fin Feedrate:** is the finish cut milling feedrate in in/min from .1 to 100, or mm/min from 5 to 2540

**Tool #:** is the tool number you assign

When the initial Irregular Profile screen is complete, the rest of the profile is programmed using A.G.E. Mill and A.G.E. Arc events. Programming with the Auto Geometry Engine is explained in Section 10.0.

## 9.9 Helix Events

The Helix Event is found after you press the MORE softkey from the Select Event screen. It allows you to machine in a circular path in the XY plane while you simultaneously move the Z-axis linearly.

Press the **HELIX** soft key.

**X Center:** is the X dimension to the center of rotation of the helix

**Y Center:** is the Y dimension to the center of rotation of the helix

**Z Rapid:** is the Z dimension to transition from rapid to feed

**Z Begin:** is the Z dimension to the beginning of the helix

**Z End:** is the Z dimension at the end of the helix

**Radius:** is the radius from the center of rotation to the helix

**Angle:** is the angle from the positive X axis (that is, 3 o'clock) to the starting position of the helix

**# Rev:** is the number of revolutions in the helix, for example, 0.75 would be 270 degrees, or 3.25 would be three times around plus 90 degrees

**Direction:** is the clockwise (input 1) or counterclockwise (input 2) direction of the helix

**Tool Offset:** is the selection of the tool offset to right (input 1), offset to left (input 2), or tool center--no offset (input 0) relative to the programmed edge and direction of the cutter movement

**XYZ Feedrate:** is the feedrate from beginning to end in in/min from .1 to 100, or mm/min from 5 to 2540

**Tool #:** is the tool you assign

## 9.10 Subroutine Events

The Subroutine Events are used for manipulating previously programmed geometry within the XY plane.

The Subroutine Event is divided into three options: Repeat, Mirror, and Rotate.

Repeat and Rotate may be connective. As long as the rules of connectivity are satisfied (see Section 5.7), the ProtoTRAK SM CNC will continue milling between preceding and subsequent events.

**REPEAT** allows you to repeat an event or a group of events up to 99 times with an offset in X and/or Y and/or Z. This can be useful for drilling a series of evenly spaced holes, duplicating some machined shapes, or even repeating an entire program with an offset for a second fixture.

Repeat events may be "nested." That is, you can repeat a repeat event, of a repeat event, of some programmed event(s). One new tool number may be assigned for each Repeat Event.

**MIRROR** is used for parts that have symmetrical patterns or mirror image patterns. In addition to specifying the events to be repeated, you must also indicate the axis or axes (X or Y or XY are allowed) that the reflection is mirrored across. In addition, you must specify the offset from absolute zero to the line of reflection. You may not mirror another mirror event, or mirror a rotate event. Consider the figure below:

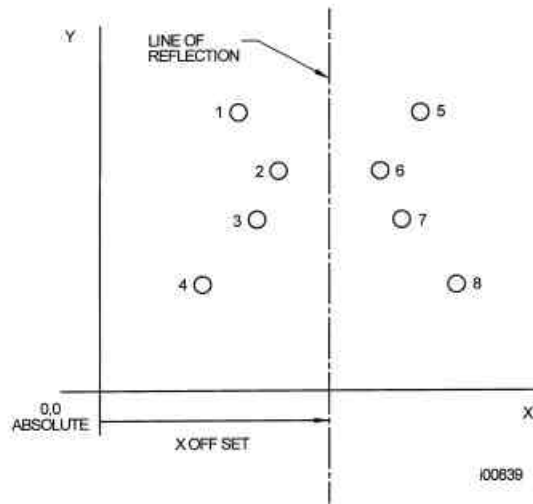

**FIGURE 9.10.1** Holes 1-4 are mirrored across the Y axis to 5-8, respectively, about a line X OFFSET from X=absolute 0

**ROTATE** is used for polar rotation of parts that have a rotational symmetry around some point in the XY plane. In addition to specifying the events to be repeated, you must also indicate the absolute X and Y position of the center of rotation, the angle of rotation (measured counterclockwise as positive; and clockwise as negative), and the number of times the specified events are to be rotated and repeated. You may not rotate another rotate event, or rotate a mirror event. Consider the figure below:

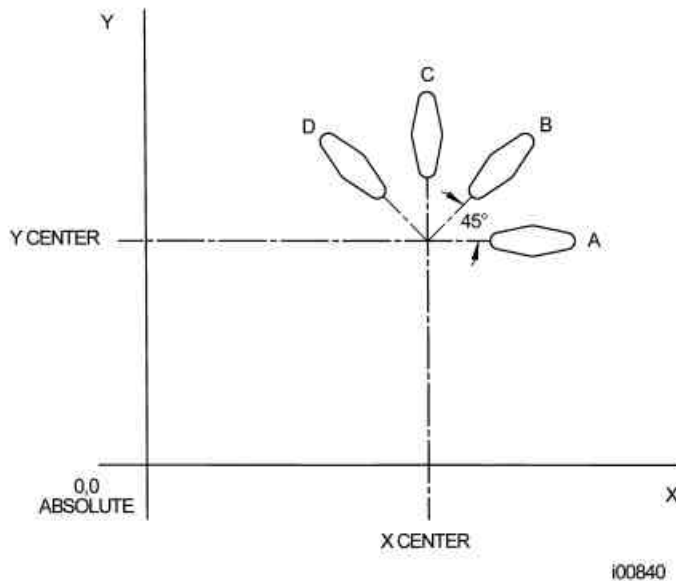

**FIGURE 9.10.2** Shape A programmed with 4 MILL events and Conrads. Using ROTATE, these 4 events are rotated through a 45 degree angle about a point offset from absolute zero by X Center and Y Center dimensions. A is rotated 3 times to produce shape B, C, and D

Press the **SUBROUTINE** (SUB) soft key to call up the Repeat, Mirror, and Rotate options.

### 9.10.1 Repeat

Press the **REPEAT** soft key.

Where:

**First Event #:** is the event number of the first event to be repeated

**Last Event #:** is the event number of the last event to be repeated; if only one event is to be repeated, the Last Event # is the same as the First Event #

**X Offset:** is the incremental X offset from event to be repeated

**Y Offset:** is the incremental Y offset from event to be repeated

**Z Offset:** is the incremental Z offset from event to be repeated

**Z Rapid Offset:** is the incremental Z rapid offset from event to be repeated

**# Repeats:** is the number of times events are to be repeated up to 99

**% Feed:** the percentage of the feeds programmed in the repeated events. 100% is assumed

**Tool #:** is the tool number you assign

### 9.10.2 Mirror

Press the **MIRROR** soft key.

**First Event #:** is the event number of the first event to be mirrored

**Last Event #:** is the event number of the last event to be mirrored; if only one event is to be mirrored, the last event is the same as the first.

**Cutting Order:** input 1 to cut from the lowest mirrored event to the highest (forward) and 2 to machine from the highest mirrored event to the lowest (backward). This way you can keep all the machine motion in a consistent direction as it moves from the original shape to the mirrored shape and keep all cutting either climb or conventional.

**Mirror Axis:** is the selection of the axis or axes to be mirrored (input X or Y or XY, SET)

**X Offset:** is the distance from Y absolute 0 to the Y-axis line of reflection

**Y Offset:** is the distance from X absolute 0 to the X-axis line of reflection

### 9.10.3 Rotate

Press the **ROTATE** soft key.

**First Event #:** is the event number of the first event to be rotated

**Last Event #:** is the event number of the last event to be rotated; if only one event is to be rotated, the last event is the same as the first

**X Center:** is the X absolute position of the center of rotation

**Y Center:** is the Y absolute position of the center of rotation

**Angle:** is the angle of rotation of the repeated events (positive is counterclockwise; negative is clockwise)

**# Repeats:** is the number of times events are to be rotated up to 99

## 9.11 COPY Events

Copy Events are programmed exactly like Subroutine Events. The only difference is that in Copy the events are rewritten into subsequent events. If, for example, in Event 11 you Copy Repeated Events 6, 7, 8, 9, 10 with 2 repeats, Events 6-10 would be copied with the input offsets into Events 11-15, and recopied into 16-20.

Copy Events may be Repeat, Mirror, or Rotate.

Copy is very useful. With copy you can:

- Edit the events that are being repeated, mirrored or rotated without changing the original events.
- Connect so that the quill will not move up to the Z Rapid position, and back down unnecessarily. However, to be connective, you must be certain that the X, Y, Z begin of the first event, once offset or rotated, coincides with the X, Y, Z end of the last event.
- Program an event parallel to X or Y (where the geometry is the easiest to describe), rotate it to the desired position, and then delete the original.
- Use the Clipboard to paste previously stored events from another program into the current program. After you press the Clipboard key, you will enter the offset from the previous program's absolute zero to the current program's absolute zero (see figure below). For information about putting events into the clipboard, see Section 11.4.

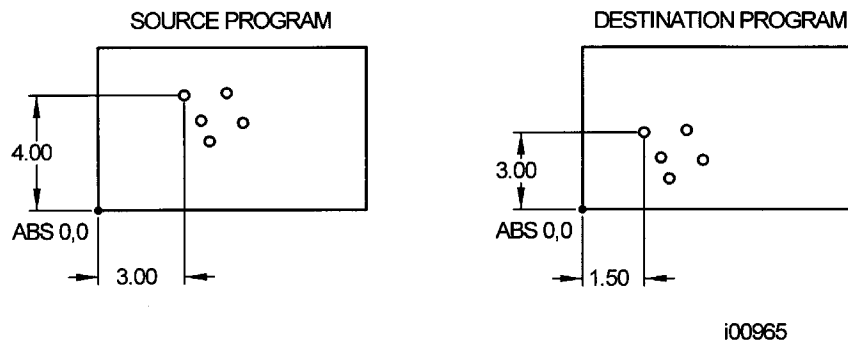

**Figure 9.10** In the above example, the offset that puts the group of holes in the desired location is  $X=-1.50$  and  $Y=-1.00$ .

## 9.12 Thread Mill Event

To program a Thread Mill event press the Thread mill soft key. This event includes an automatic move in and out of the thread.

Prompts in the Thread Mill event:

**X CENTER:** the X dimension of the center of the thread

**Y CENTER:** the Y dimension of the center of the thread

**Z RAPID:** the Z dimension where the Z rapid feed slows to Z program feed

**Z BEGIN:** the Z dimension where the threading pass begins

**Z END:** the Z bottom of the thread

**PITCH:** the distance from one thread to the next in inches or mm. It is equal to one divided by the number of threads per inch. For example, the pitch for a 1/4-20 screw is  $1 \div 20 = .05$  inches

**MAJOR DIA:** the largest diameter of the thread (the root for an ID thread, the crest for an OD thread)

**MINOR DIA:** the smallest diameter of the thread (the root for an OD thread, the crest for an ID thread)

**SIDE:** input 1 for inside, 2 for outside

**ANGLE:** the angle the tool feeds into the beginning depth

**# PASSES:** - the number of passes to cut the thread to its final depth

**DIRECTION:** clockwise or counterclockwise

**Z FEEDRATE:** the feedrate from Z Rapid to Z Begin

**XYZ FEEDRATE:** the feedrate of XYZ along the path of the helix.

**FIN CUT** - width of the finish cut. If 0 is input, there is no finish cut.

If something other than 0 is input for finish cut, the following prompt appears:

**FIN FEEDRATE** - the milling feedrate for the finish cut.

### 9.13 PAUSE Events

The purpose of the Pause Event is to allow you to program a stop condition within the program. The effect of this event is to turn off the spindle, move the head to the Z retract location with the X and Y position corresponding to the end of the previous event and stopping the program run.

Pause events are useful if you want to stop the program to activate an indexer, make a measurement, change a fixture, etc.

*NOTE: In general, you should avoid programming a PAUSE event between two connective events. The Pause event will cause the events to **NOT** be connective.*

To program a Pause Event press the **PAUSE** soft key. Because there is no input required, simply press SET to load and the event counter will advance by one and the Select Event screen will reappear.

In run, press the **GO** key after a pause to continue.

### 9.14 Engrave Event

The Engrave Event allows you to machine numbers, letters and special characters as part of a part program. See figure 9.14 below for the letters and special characters that are available in the Engrave Event.

When programming with the Engrave Event, the ProtoTRAK will construct a box to contain the text you define. This box is oriented along the X axis like the text in this sentence, and you may program up to 40 characters per event (although you will only be able to see 20 characters on the prompts screen). To machine text in a direction other

than the X axis, simply use multiple Engrave Events and place the lower left corner of the box wherever you would like. The numbers and letters you program will always have a standard orientation (like the letters on this page) – you cannot program tilted or inverted letters with the Engrave Event. The letters are of the font shown in the figure and all capitals.

### Prompts for the Engrave Event

First, define the lower left corner of the box that will contain your text:

**X BEGIN:** The X coordinate of where you want your text to begin

**Y BEGIN:** The Y coordinate of where you want your text to begin

**Z RAPID:** The Z dimension where the Z rapid feed slows to Z program feed

**Z END:** The Z dimension to the bottom of your text.

**HEIGHT:** The height of your text. Each character varies in width; the set height of the character will change the width in order to keep the overall size of the character proportional.

**TEXT:** The text to be milled. When you get to this prompt, the Alpha keys will automatically pop up to allow you to enter the text. Once you have finished entering text, you must press End (F8) and then any of the SET keys to successfully enter your text into the event. The alpha keys will appear automatically if the text field is blank. If you have already entered text but wish to make a change, you will see a blue question mark appear on the lower left corner of the screen when you scroll to this field, press the Help button and the alpha keys will appear.

**Z FEEDRATE:** Is the feedrate from Z rapid to Z end

**XYZ FEEDRATE:** The feedrate of XYZ along the path of the text

**Tool #:** is the tool number you assign

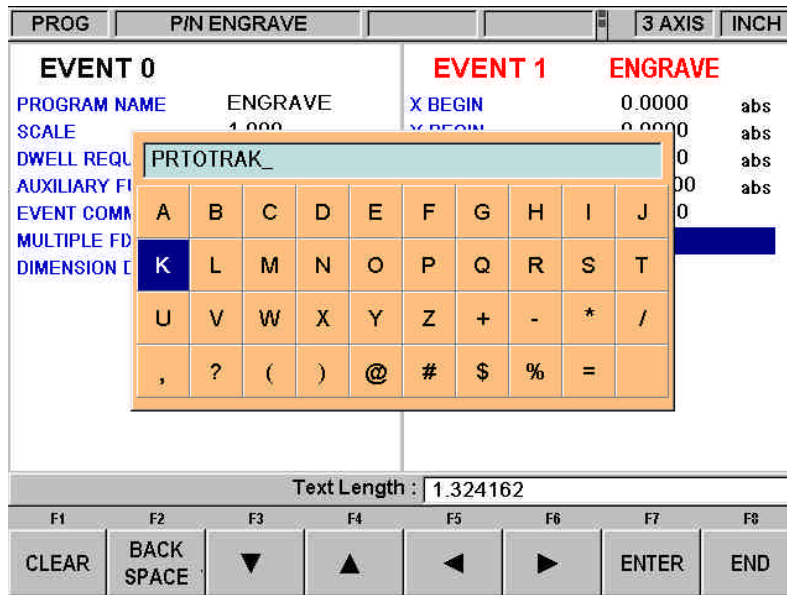

**FIGURE 9.14** The above figure shows the text and special characters available for the Engrave event. Notice the field that is labeled “Text Length”. This field will display the total length of your programmed text and will update will update as you enter each character.



## 9.15 Finishing Teach Events

Teach events are either POSN, DRILL or MILL events that are originated in the DRO Mode (see Section 6.6).

The Teach events that are started in the DRO Mode must be finished in the Program Mode before running. Teach events are of these different types:

**TEACH POSN** - for two-axis operation, the Position and Drill event types are combined. See Section 8.1 for a description of Position event prompts.

**TEACH DRILL** - this may also be made into a bore event. See Section 8.2 for a description of Drill event prompts.

**TEACH MILL** - a straight line that specifies the beginning and the end. When TEACH MILL events are defined using the CONT MILL softkey, the prompts for information that cannot change will be suppressed. See Section 8.4 for a description of Mill event prompts.

When a Teach event is unfinished, the words NOT OK will appear next to the event type. Once the prompts are completed, the words NOT OK and Teach will disappear. The event will become a normal MILL, DRILL, or POSN event.

# 10.0 Auto Geometry Engine (A.G.E) Programming

When you program an Irregular Pocket or an Irregular Profile the Auto Geometry Engine, or A.G.E. is automatically started.

The A.G.E. is powerful software that works behind the easy-to-use geometry programming of the ProtoTRAK SM CNC. It is treated in its own section because it works differently than the other event types. Unlike other events, the A.G.E. allows you to:

- Enter the data you know, and skip the prompts you don't.
- Use different types of data (like angles) that may be available from the print.
- Enter guesses for the X and Y ends and centers not available on the print.

With the A.G.E., you can easily overcome limitations in the data the print provides without having to spend time in laborious calculations.

## 10.1 Starting the A.G.E.

The A.G.E. is started automatically when you enter the Irregular Pocket or Irregular Profile event. The first set of prompts you encounter will be the header information. Once that information is entered, you will see the following screen:

PROG	P/N P/N 0812-2	TOOL# 1	3 AXIS	INCH
<b>EVENT 1</b>		<b>IRR PROFILE</b>		
X BEGIN	0.0000	abs		
Y BEGIN	0.0000	abs		
Z RAPID	0.0500	abs		
Z END	-0.2500	abs		
TOOL OFFSET	RIGHT			
# PASSES	2			
FIN CUT	0.0100			
Z FEEDRATE	4.0			
XYZ FEEDRATE	15.0			
FIN FEEDRATE	10.0			
TOOL #	1			
<div style="border: 1px solid black; background-color: green; color: white; padding: 5px; display: inline-block;">Select an event.</div>				
EVENT 2				
F1	F2	F3	F4	F5
F6	F7	F8		
A.G.E. MILL	A.G.E. ARC			
			END A.G.E.	ABORT A.G.E.

**FIGURE 10.1** Once the profile header screen is finished, you choose between an A.G.E. Mill and an A.G.E. arc to define the shape. The screen above shows three-axis CNC programming.

Where:

**A.G.E. Mill:** A straight line from one X Y point to another.

**A.G.E. Arc:** Any part of a circle.

**End A.G.E.:** Ends the A.G.E. programming for the Irregular Pocket or Irregular Profile.

**Abort A.G.E.:** Aborts all A.G.E. events. The data for all the events is lost.

## 10.2 A.G.E. Mill Prompts

Press the A.G.E. Mill key.

PROG	P/N P/N 0812-2	TOOL# 1	3 AXIS	INCH
<b>EVENT 1</b>		<b>IRR PROFILE</b>		<b>EVENT 2</b>
X BEGIN	0.0000	abs	TANGENT	
Y BEGIN	0.0000	abs	X END	0.0000 abs
Z RAPID	0.0500	abs	Y END	
Z END	-0.2500	abs	CONRAD	
TOOL OFFSET	RIGHT		ANGLE END	
# PASSES	2		LENGTH	
FIN CUT	0.0100		LINE ANGLE	
Z FEEDRATE	4.0			
XYZ FEEDRATE	15.0			
FIN FEEDRATE	10.0			
TOOL #	1			
Not OK				
Y END :				
F1	F2	F3	F4	F5
PAGE FWD	PAGE BACK	DATA FWD	DATA BACK	DATA BOTTOM
				INSERT EVENT
				DELETE EVENT
				GUESS

**FIGURE 10.2** A.G.E. Mill prompts. Enter what you know, skip or guess the ones you don't

Prompts in A.G.E. Mill programming:

**Tangent:** this refers to the tangency of the mill to the previous event. See Section 10.11 for a discussion of tangency.

**X END:** is the X dimension to the end of the mill cut; incremental is X Begin

**Y END:** is the Y dimension to the end of the mill cut; incremental is Y Begin

**CONRAD:** is the dimension of a tangential radius to the next event

**ANGLE END:** is the angle measured counterclockwise from this mill event to the next. Do not input if the next event is an arc

**LENGTH:** is the length of the mill from beginning to end

**LINE ANGLE:** is the angle of this mill line (moving from begin to end) measured counterclockwise from the positive X axis (that is 3 o'clock)

**GUESS:** This softkey will appear when the prompt is on X or Y dimensioned data. Press the Guess key before you press INC SET or ABS SET to enter the data as a guess. See Section 10.7

### 10.3 A.G.E. Arc Prompts

Press the A.G.E. ARC key.

Prompts in A.G.E. Arc programming:

**Tangent:** this refers to the tangency of the mill to the previous event. See Section 10.11 for a discussion of tangency.

**DIRECTION:** is the clockwise (input 1), or counterclockwise (input 2) direction of the arc

**X END:** is the X dimension to the end of the arc cut; incremental is from X Begin

**Y END:** is the Y dimension to the end of the arc cut; incremental is from Y Begin

**X CENTER:** is the X dimension to the center of the arc; incremental is from X End

**Y CENTER:** is the Y dimension to the center of the arc; incremental is from Y End

**CONRAD:** is the dimension of a tangential radius to the next event

**RADIUS:** is the radius of the arc

**CHORD LENGTH:** is the straight line distance from the begin point to the end point

**CHORD ANGLE:** is the angle spanned by the arc

In addition to the normal Softkeys, this additional one will appear in A.G.E. Arc programming:

**GUESS:** this softkey will appear when the prompt is on X or Y dimensioned data. Press the Guess key before you press INC SET or ABS SET to enter the data as a guess. See Section 10.7

### 10.4 Skipping Over Prompts

In the A.G.E., events don't have to be fully defined before you can go to the next one. You can skip the data you don't know by using the DATA FWD softkey. After you press the DATA FWD key at the last prompt, the event will move to the left side of the screen and the Select Event screen will appear.

When skipping over prompts or editing, always use the DATA FWD or DATA BACK key. Using INC SET or ABS SET will change the data.

If you want the event back on the right side, use the BACK hard key.

### 10.5 The OK/NOT OK Flag

Each A.G.E. event has a flag that tells you if it has been fully defined. Sometimes data from later events is needed to define previous events. To the immediate right of the event type, the words OK or NOT OK appear, depending on whether that particular event is defined.

Once the OK flag appears for the event, you do not need to enter more information. Skip past the rest of the prompts with the DATA FWD softkey.

If you leave the Program Mode and then return, pressing the GO TO END softkey will take you automatically to the first NOT OK event.

## 10.6 Ending A.G.E.

Any time all the events of an Irregular Profile are OK, the A.G.E. may be ended. If you are programming an Irregular Pocket, there is an additional requirement that must be satisfied before the A.G.E. may be ended: the X and Y end point of the last event must be the same as the X and Y beginning point, so that the pocket is closed. Otherwise, the ProtoTRAK SM CNC cannot program the tool path to clear the pocket.

The Irregular Profile has no such restriction since profiles may be open or closed.

Once the A.G.E. is ended, the Irregular Pocket or Irregular Profile event is complete and you may then choose from all the programming canned cycles from the Select an Event screen. To reopen the A.G.E. Profile or Pocket, simply use the BACK hard key or the PAGE FWD or PAGE BACK softkeys to position on of the A.G.E. events on the right side of the screen. You may edit or insert other events.

## 10.7 Guessing Data

Whenever you are missing X or Y Ends or Centers, you should generally enter a guess. Gussed data is treated differently by the ProtoTRAK SM CNC than regular data. Often, the information you put into the system will allow it to calculate a mathematically correct line or arc that would satisfy the conditions of the hard data you entered. This line or arc may yield more than one solution to particular point you are looking for. That is where the Guess comes in: the A.G.E. uses the guess to choose from the mathematically possible solutions. In most cases, your guesses do not have to be very precise. The smaller the lines or arcs, the more precise the guess should be.

PROG	P/N P/N 0812-2		TOOL# 1	3 AXIS	INCH		
<b>EVENT 1</b>	<b>IRR PROFILE</b>		<b>EVENT 2</b>	<b>A.G.E. MILL</b>	<b>Not OK</b>		
X BEGIN	0.0000 abs		TANGENT				
Y BEGIN	0.0000 abs		X END	G 1.0000 abs			
Z RAPID	0.0500 abs		Y END				
Z END	-0.2500 abs		CONRAD				
TOOL OFFSET	RIGHT		ANGLE END				
# PASSES	2		LENGTH				
FIN CUT	0.0100		LINE ANGLE				
Z FEEDRATE	4.0						
XYZ FEEDRATE	15.0						
FIN FEEDRATE	10.0						
TOOL #	1						
Y END : █							
F1	F2	F3	F4	F5	F6	F7	F8
PAGE FWD	PAGE BACK	DATA FWD	DATA BACK	DATA BOTTOM	INSERT EVENT	DELETE EVENT	GUESS

**FIGURE 10.7** The X End dimension has been entered as a guess—note the letter G

Guesses should always be entered as absolute dimensions. Once entered, the system labels the gussed data by placing a 'G' next to it. Gussed data will be labeled this way in all the events that are flagged NOT OK. Once an event is OK, the gussed data will be

replaced by calculated data. If you wish to edit your guesses, placing it on the right side of the screen will cause your original guessed data to reappear.

## 10.8 LOOK and Guess

Guessed data may be entered by pressing the number keys and then SET. However, you may find it more convenient to use the LOOK graphics to enter guesses.

When the highlight is on the prompt for which you wish to enter a guess, press the Guess key. The Data Input Line will say "Enter Guess for X END" (for example). At this point, press the LOOK key.

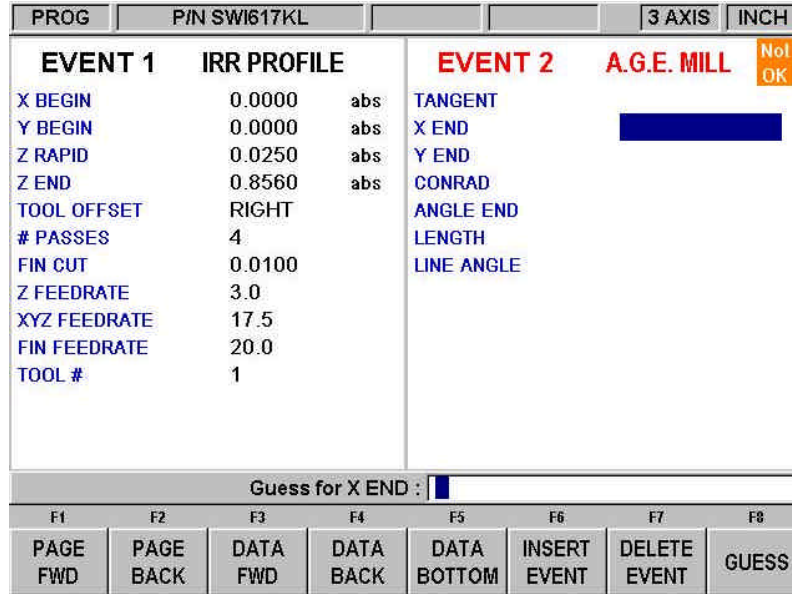

**Figure 10.8.1** When the Data Input Line says "Enter Guess" pressing LOOK gives you the ability to use graphics to make your guesses.

On the screen shown in the figure above, the Data Input Line says "Enter Guess for X BEG". Pressing LOOK at this point will take you to a special version of the LOOK graphics. Using a mouse or the cursor keys, you may move a point around the screen. When you come to the place where your point is, use the Enter key.

The softkeys for this special version of the LOOK graphics:

← → ↑ ↓ - move the cursor around the screen.

**ZOOM IN** - makes the drawing larger.

**ZOOM OUT** - makes the drawing smaller.

**ENTER END** - when the cursor is at the point you want to use as a guess, use this to enter the end point of a line or an arc.

**ENTER CENTER** - use this to enter a guess for the center of an arc.

You can enter a combination of guessed and non-guessed data. For example, if you were to enter the dimension for X End without guessing, you would still be able to enter the dimension of Y End using guess.

Your guess entries are loaded into the program when you exit the LOOK screen by pressing BACK or by pressing LOOK again. The ProtoTRAK will use the last ENTER key press and load that into the program.

When you use the graphics to guess dimensions on arcs, you may load in guesses for both the X/Y End and the X/Y Center before leaving the LOOK screen.

When you have not first pressed the Guess key, pressing LOOK gives you the same screen as in regular programming. Whether you enter the guesses as key presses or by using the graphics, the drawing of the LOOK screen distinguishes between events that are fully defined and those that rely on guessed data. OK events are represented by solid lines. NOT OK events are represented by dashed lines.

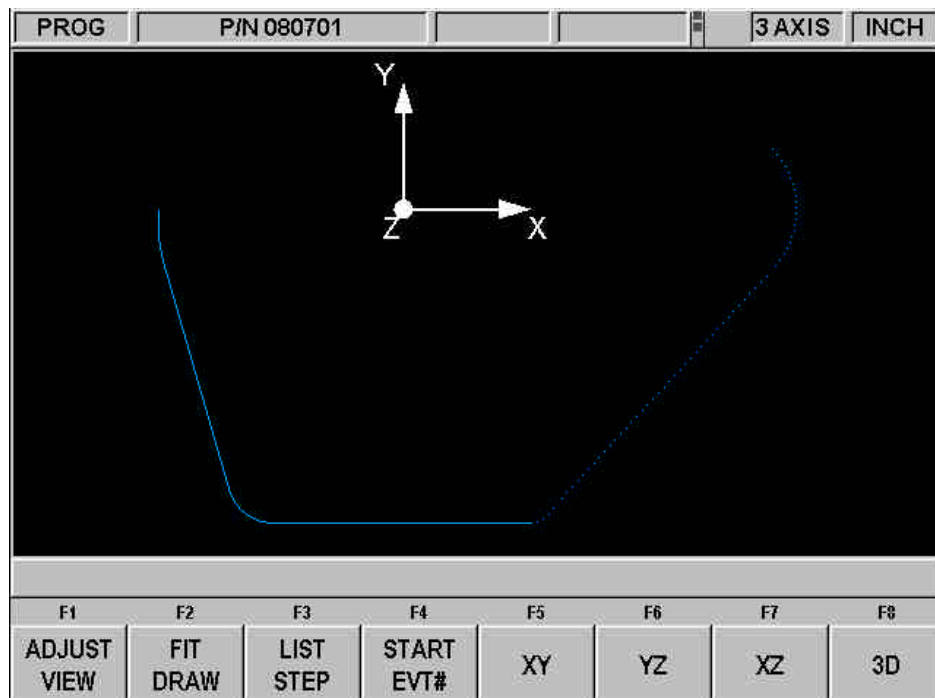

**FIGURE 10.8.2** when the events are calculated based on Guessed data, they are represented by a dotted line

### 10.9 Calculated Data

Prompts that are skipped or for which guesses are entered may be replaced by data calculated by the ProtoTRAK SM CNC. Calculated data is shown in red in order to distinguish it from the data that you entered. You cannot edit calculated data, but you may edit your original input. By putting the event with the calculated data on the right side of the screen, you may position the cursor to the prompt and re-input the data.

### 10.10 Arcs and Conrads

If the print is missing a lot of data, it may be desirable to program arcs as separate events where possible. This gives the system more information to work with.

### 10.11 Tangency

Tangency can occur between a mill and arc or an arc and arc. Specifically it means that the two events share one and only one point. You would answer yes to the TANGENCY prompt if the event you are programming is tangent to the **previous** event. The

information that events are tangent helps the Auto Geometry Engine calculate other dimensions.

You can often tell by looking at the print if events are tangent: tangent intersections tend to blend smoothly, without a sharp corner.

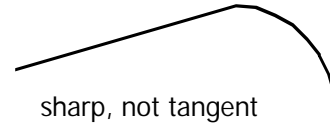
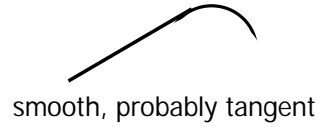

For the A.G.E., the tangent mill or arc are assumed to continue in the same direction, and not double back on the previous event:

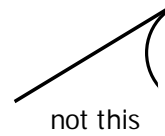
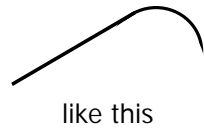





# 11.0 Edit Mode

Within Program Mode, you can recall and re-input specific data prompt by prompt. The Edit Mode contains powerful routines for more extensive program changes.

The changes you make in the Edit Mode affect only the program in current memory. In order to preserve the changes for future use, the program must be stored again under the same name in the In/Out Mode.

## 11.1 Delete Events

To delete a group of events in the program, press Delete Events.

The Data Input Line will prompt for the first event to be deleted. Input the event number of the first event and press set. Next the Data Input Line will prompt for the last event number to be deleted. Put in the last number and press Set.

The remaining events will be renumbered.

## 11.2 Spreadsheet Editing

Spreadsheet Editing allows you to view program inputs in a table and make global changes to the program. This is particularly useful if you are working with a large program and you need to make a change to many events.

When you press the SEARCH EDIT softkey, the screen will load a table that contains data for every event. See Figure 11.2.1

EDIT		P/N R0424-11			TOOL# 1	3 AXIS	INCH
EVT#	TYPE	TOOL#	Z FEED	XYZ FEED	FIN FEED	Z RAPID	CONRAD
1	POSITION	1 (0.2500)				0.1000 abs	
2	DRILL	1 (0.2500)	5.0			0.0000 inc	
3	BOLT HOLE	1 (0.2500)	5.0			0.1000 abs	
4	MILL	2 (0.3750)	5.0	10.0		0.0000 inc	0.0000
5	MILL	2 (0.3750)	5.0	10.0		0.0000 inc	0.0000
6	MILL	2 (0.3750)	5.0	10.0		0.0000 inc	0.0000
7	ARC	2 (0.3750)	5.0	10.0		0.0000 inc	0.0000
8	CIRC PCKT	2 (0.3750)	5.0	10.0	10.0	0.1000 abs	
9	TAP	3 (0.1875)				0.1000 abs	
10	HELIX	3 (0.1875)	5.0	10.0		0.1000 abs	
11	THREAD MILL	4 (0.2400)	5.0	10.0	10.0	0.1000 abs	
12	POSITION	3 (0.1875)				0.1000 abs	

TOOL # : 1

F1	F2	F3	F4	F5	F6	F7	F8
PAGE FWD	PAGE BACK	▼	▲	◀	▶	SORT	CHANGE ALL

FIGURE 11.2.1 The Search Edit softkey launches Spreadsheet Editing. View the entire program by the variables you select

The first time the screen appears, the data is sorted by event number. Each row represents the data for the event number shown in the first column on the left. The event number is always displayed in the first column, but the other data displayed on the table can be changed.

Soft Keys in Search Edit:

**PAGE FWD:** pages forward through the table.

**PAGE BACK:** pages backwards through the table.

▼ ▲ ◀ ▶ : highlights data for editing. Only data that is highlighted and appears in the Data Input Line may be edited. Note: the EVT# (event number) and (event) TYPE may not be edited in Search Edit so the highlighter will not go there.

**SORT:** enables you to change the sort to any of the data displayed. See Section 11.2.2

**CHANGE ALL:** enables you to make global changes of data. See 11.2.3

### 11.2.1 Selecting Data to be Displayed on the Search Edit Table

In order to change the data selected in the table, press the HELP hard key. There will be a listing of all the data types that may be edited in Search Edit. Press the RETURN soft key and the table will be reloaded with the data that you selected.

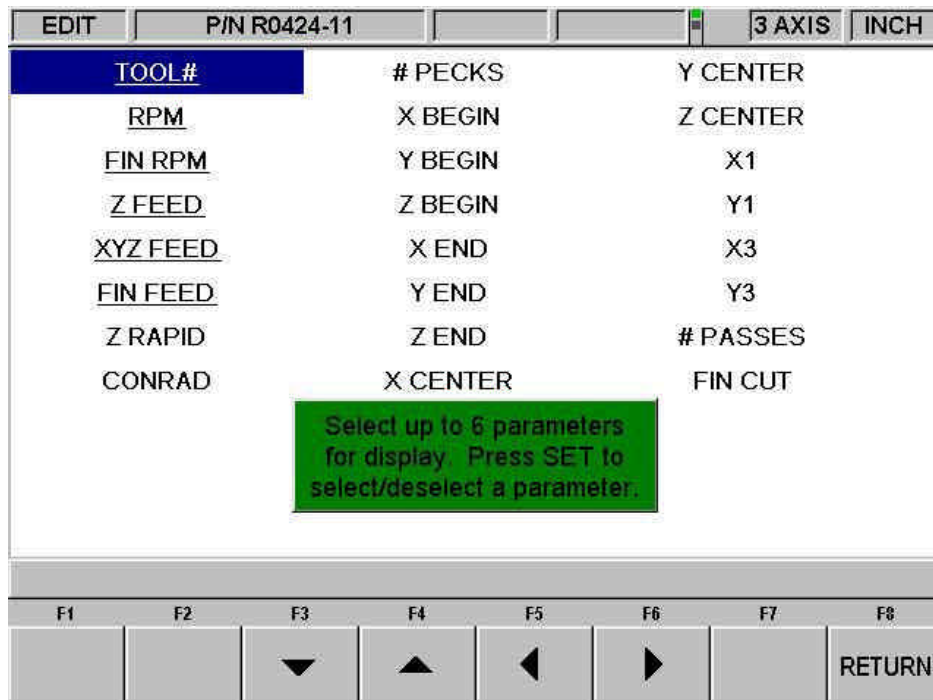

**FIGURE 11.2.2** Pressing Help while viewing the spreadsheet lets you change the program parameters

After you press the HELP hard key, the screen will display all the different parameters that can be displayed on the spreadsheet. To either select or deselect any parameter, simply highlight that parameter and press SET. When you are finished, press the Return softkey and return to the spreadsheet.

### 11.2.2 Sorting Data

Data may be sorted by any of the data types displayed in the column head. Red letters show which column is used for sorting the data.

To change the sort, press the SORT softkey, then select the type of data you want to use for sorting from the softkeys.

The table will be changed to sort the data in ascending order (the smallest value first, the largest last).

### 11.2.3 Making Global Changes to Data

Sometimes it is useful to be able to change data in a program without having to go through each event one at a time. For example, if you were to want to change the tool number for every milling event, it may be a chore to go through each event in a long program to make the changes on that event type.

In order to make global changes:

1. Sort the data in a way that groups together the things you want to change.
2. Highlight the data value that is highest on the table (nearest to the top) that you want changed.
3. Press the CHANGE ALL softkey. All the inputs that are the same as the one you highlighted and are listed together below the data you highlighted will then be highlighted.
4. Enter the new value, then press set. All the highlighted data will be changed to the value you just input.

**Example:**

From the screen shown in Figure 11.2.1, we will change the Z Feed for each of the mill events in the program.

1. Sort by event type to get all the Mill events together.
2. Highlight the Z Feed in the first Mill event (Event # 8). See Figure 11.2.3
3. Press the CHANGE ALL softkey. All the Z Feeds in the Mill events are highlighted. See Figure 11.2.4
4. Type in the new Z Feed value and press INC SET or ABS SET. See Figure 11.2.5

In this example, the Z feed is changed from 5.0 to 7.0 for all the Mill Events.

EDIT		P/N R0424-11			3 AXIS		INCH	
EVT#	TYPE	TOOL#	Z FEED	XYZ FEED	FIN FEED	Z RAPID	CONRAD	
14	BOLT HOLE	3 (0.1875)	5.0			0.1000 abs		
25	BOLT HOLE	1 (0.2500)	5.0			0.1000 abs		
36	BOLT HOLE	3 (0.1875)	5.0			0.1000 abs		
4	MILL	2 (0.3750)	5.0	10.0		0.0000 inc	0.0000	
5	MILL	2 (0.3750)	5.0	10.0		0.0000 inc	0.0000	
6	MILL	2 (0.3750)	5.0	10.0		0.0000 inc	0.0000	
15	MILL	3 (0.1875)	5.0	10.0		0.0000 inc	0.0000	
16	MILL	3 (0.1875)	5.0	10.0		0.0000 inc	0.0000	
17	MILL	3 (0.1875)	5.0	10.0		0.0000 inc	0.0000	
26	MILL	2 (0.3750)	5.0	10.0		0.0000 inc	0.0000	
27	MILL	2 (0.3750)	5.0	10.0		0.0000 inc	0.0000	
28	MILL	2 (0.3750)	5.0	10.0		0.0000 inc	0.0000	

? Z FEEDRATE : 5.0

F1	F2	F3	F4	F5	F6	F7	F8
PAGE FWD	PAGE BACK	▼	▲	◀	▶	SORT	CHANGE ALL

FIGURE 11.2.3 After sorting by Event Type, the highlighter is placed on the Z feed of the first Mill Event

EDIT		P/N R0424-11			3 AXIS		INCH	
EVT#	TYPE	TOOL#	Z FEED	XYZ FEED	FIN FEED	Z RAPID	CONRAD	
14	BOLT HOLE	3 (0.1875)	5.0			0.1000 abs		
25	BOLT HOLE	1 (0.2500)	5.0			0.1000 abs		
36	BOLT HOLE	3 (0.1875)	5.0			0.1000 abs		
4	MILL	2 (0.3750)	5.0	10.0		0.0000 inc	0.0000	
5	MILL	2 (0.3750)	5.0	10.0		0.0000 inc	0.0000	
6	MILL	2 (0.3750)	5.0	10.0		0.0000 inc	0.0000	
15	MILL	3 (0.1875)	5.0	10.0		0.0000 inc	0.0000	
16	MILL	3 (0.1875)	5.0	10.0		0.0000 inc	0.0000	
17	MILL	3 (0.1875)	5.0	10.0		0.0000 inc	0.0000	
26	MILL	2 (0.3750)	5.0	10.0		0.0000 inc	0.0000	
27	MILL	2 (0.3750)	5.0	10.0		0.0000 inc	0.0000	
28	MILL	2 (0.3750)	5.0	10.0		0.0000 inc	0.0000	

Z FEEDRATE : 5.0

F1	F2	F3	F4	F5	F6	F7	F8
							RETURN

FIGURE 11.2.4 Pressing the Change All softkey highlights the Z feed for all the Mill events

EDIT		P/N R0424-11			3 AXIS		INCH	
EVT#	TYPE	TOOL#	Z FEED	XYZ FEED	FIN FEED	Z RAPID	CONRAD	
14	BOLT HOLE	3 (0.1875)	5.0			0.1000 abs		
25	BOLT HOLE	1 (0.2500)	5.0			0.1000 abs		
36	BOLT HOLE	3 (0.1875)	5.0			0.1000 abs		
4	MILL	2 (0.3750)	7.0	10.0		0.0000 inc	0.0000	
5	MILL	2 (0.3750)	7.0	10.0		0.0000 inc	0.0000	
6	MILL	2 (0.3750)	7.0	10.0		0.0000 inc	0.0000	
15	MILL	3 (0.1875)	7.0	10.0		0.0000 inc	0.0000	
16	MILL	3 (0.1875)	7.0	10.0		0.0000 inc	0.0000	
17	MILL	3 (0.1875)	7.0	10.0		0.0000 inc	0.0000	
26	MILL	2 (0.3750)	7.0	10.0		0.0000 inc	0.0000	
27	MILL	2 (0.3750)	7.0	10.0		0.0000 inc	0.0000	
28	MILL	2 (0.3750)	7.0	10.0		0.0000 inc	0.0000	

? Z FEEDRATE : 7.0

F1	F2	F3	F4	F5	F6	F7	F8
PAGE FWD	PAGE BACK	▼	▲	◀	▶	SORT	CHANGE ALL

FIGURE 11.2.5 Type the new Z Feed and then SET to change all the highlighted values from 5 to 7.

### 11.3 Erase Program

Use the ERASE PROG soft key to erase the program from the current memory. Erasing the program from current memory will not affect any programs that are stored.

If you have made changes to the program and wish to save this modified program, you will need to store it. See Section 14.4

### 11.4 Clipboard

The Clipboard feature is a way to copy events in one program in order to put them into a different program. It is a two-part process that takes place in two different Modes. First, in the Edit Mode, the desired events are copied, or placed on the Clipboard, from the source program. Then the events are inserted into the destination program in the Program Mode.

When you press the Clipboard key from the Edit Mode, you start the process that copies the events that you want to put into a different program than the one in current memory.

Before you do that, you should write a program or open the program file that has the events you want to copy. This is called the source program.

Inspect the events you want to copy. Make sure that the dimensioned data uses Absolute references in the first event to be copied and in all events where it will be important. Incremental references may be used, but keep in mind where the Incremental reference will be made from. See the section on Incremental Reference Position in this manual.

In addition, you may want to modify this program in order to get all the events you want together. For example, if you want to copy events 2-5 and 7-12, you may want to modify the program to delete events 1 and 6 first. That way, you can copy the all the events as they are now numbered from 1 to 10. Remember that you can modify this program just for this purpose and it will not affect the original program unless you save it with the modifications in the Program In/Out Mode.

When the source program is ready, press the CLIPBOARD softkey. A message will appear that says "Copy Events Onto Clipboard" and the Data Input Line will read "From Event". Enter the number of the first event that you want copied and press SET.

The Data Input Line will read "To Event". Enter the number of the last event you want copied and press SET.

The group of events that you have specified is now on the clipboard and will remain there until you replace it with something else by going through the same procedure. When power is turned off to the CNC the clipboard information will also be lost.

The events on the clipboard are inserted into a program in the Program Mode. See Section 9.10.

## 12.0 Set Up Mode

The Set Up Mode contains the tool library, the tool path graphics and the machine's reference positions. Enter the Set-Up Mode by pressing the SET-UP soft key at the Select Mode screen.

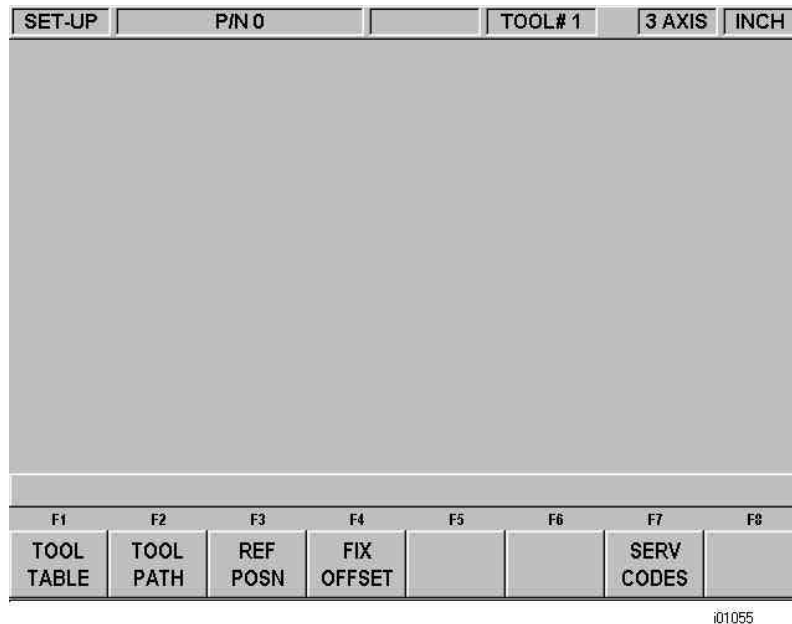

FIGURE 12.0 The Set-Up mode

### 12.1 The Tool Table

From the screen above, press the TOOL TABLE softkey.

TOOL #	DIAMETER	Z OFFSET	Z MODIFIER
REF		NOT SET	
1	0.2500	0.0000	0.0000
2	0.3750	0.0000	0.0000
3	0.1875	0.0000	0.0000
4	0.2400	0.0000	0.0000
5	0.0000	0.0000	0.0000
6	0.0000	0.0000	0.0000
7	0.0000	0.0000	0.0000
8	0.0000	0.0000	0.0000
9	0.0000	0.0000	0.0000
10	0.0000	0.0000	0.0000
11	0.0000	0.0000	0.0000
12	0.0000	0.0000	0.0000
13	0.0000	0.0000	0.0000
14	0.0000	0.0000	0.0000
15	0.0000	0.0000	0.0000

TOUCHOFF REFERENCE POINT : █

FIGURE 12.1 The Tool Table



### 12.1.1 The Tool Table Screen

When you first enter the tool table by pressing the TOOL TABLE soft key, you will see the screen shown in Figure 12.1.

**Tool #:** the number of the tool from 1 to 99. Tool numbers shown in red are active for the program in current memory.

**Diameter:** the diameter of the tool.

**Z Offset:** the difference between the Z position of the tool and the Z position of the reference. The Z offset is always relative to a reference point. Before the reference point is set, the highlight will not go into the Z Offset column because setting a Z offset before the Z reference is set has no meaning.

**Z modifier:** a value you enter to make adjustments for the tool depth. See 12.1.8 below.

**Ref:** the reference position for the Z offset. Before the reference position is set (and the Ref row reads "NOT SET") the highlight will not go into the Z Offset column. Once it is set, the highlight will not go into the Ref row, that is, you will not be able to highlight and reset your reference once it says "SET".

The soft keys in the tool table:

**DATA DOWN, DATA UP, DATA LEFT, DATA RIGHT:** move the highlight around the table.

**ERASE TABLE:** clears all tool information so you can start over. See 12.1.4 below.

**JOG:** puts the ProtoTRAK SM CNC into the DRO jog operation (see Section 6.3).

**RETURN:** reverts to the SET UP mode screen.

The electronic handwheels are active, including the fine/coarse selection, while you are in the tool table.

### 12.1.2 Simple Tool Set-Up for Two-Axis CNC Machining

When machining in two-axis CNC, you have a choice for how much tool set-up you want to do. At a minimum, you must tell the ProtoTRAK SM the tool diameter for all the active tools in the program (active tools have red numbers) when you want tool compensation applied or when you are machining a pocket.

If you want Z tool offsets applied to the DRO measurement, you can do the set-up steps in the following sections. For most two-axis work, however, this is not worth the effort. During program run, you can easily set or zero out your Z dimensions when you change tools.

If you want to do the minimum, simply enter the diameters for the active tools in the Tool Table. Please also read Sections 12.1.5, 12.1.10 and 12.1.11 for general information about the tool table. The other 12.1 sections may be safely ignored. Doing without the tool set up is one of the benefits of using a two-axis CNC.

### 12.1.3 The Logic of the Tool Table

The tool table is organized to do the following:

- Make it easy to set up tools.
- Make it easy to replace a tool or add a tool.
- Retain tool information in memory to reduce set-up.

You assign tool numbers as you write a program. These tool numbers may be from 1 to 99. Before machining, the diameters and Z offset of each of the tools in the program

must be defined so that the ProtoTRAK SM CNC can calculate the tool path. Tools that are used in the program that is in current memory are called active tools and their numbers are in red in the tool table.

When you save a program, all the tool information for active tools is saved with it. When the program is opened, the tool information is put into the tool table. This information will replace any information that already is in the tool table for the same tool numbers.

In addition to information about the tools used in a program, you may load in information for tools to be used in 2-axis CNC or in the DRO mode for machining manually. When you tell the ProtoTRAK SM CNC which tool you are using, it will adjust the Z DRO dimensions accordingly so you don't have to touch off and reset after a tool change.

The idea of retaining tool information in memory in order to reduce the amount of set-up needed requires that care be taken to avoid mistakes. Milling work usually requires a lot of tools, many of which are not preset into fixed tool holders. That means tool information that is not very recent is probably no good.

Think of the information in the tool table this way: if you clearly remember setting the tools and entering the diameters very recently, then use the tool table in DRO and CNC run. If you can't remember setting the tools clearly, erase the table and start over – it only takes a moment.

This may cause some confusion because the normal sequence for running a two-axis program is to load in a tool, touch it off and set zero, then press GO. The ProtoTRAK SM CNC will apply the tool offset after the GO press, making the Z dimension meaningless.

You have two choices:

1. Use the tool table, setting the reference and absolute dimension for one of them per the instructions above. This will save you from having to touch off tools every time they are changed in program Run.
2. Don't use the tool table. Erase the entire tool data so that the ProtoTRAK SM CNC will not try to apply offsets.

#### 12.1.4 Initial Tool Set-Up

This procedure is used for setting up tools when the tool table is clear.

1. When you enter this screen for the first time, the words "NOT SET" appear directly under the Z OFFSET column in the REF row. The Data Input Line reads "TOUCHOFF REFERENCE POINT". This is prompting you to establish a reference for the rest of your tools.
2. To establish a reference, put a cutting tool or some other reference setting tool into the spindle and touch the tool to a surface. We recommend that you use something besides a tool that you intend to use machining the job. Ideally, you will have a reference tool that you keep handy for setting up your tools every time. That way, a reference point can be easily re-established later.
3. We also recommend that you use the top of the vice or table as your reference surface because it is constant and never changes.
4. With the highlight on the screen on the words "NOT SET" and the tool touching some reference point, press SET.

*NOTE: If you do use a tool as your reference tool and it breaks, you must retouch off all tools.*

5. The words will change from "NOT SET" to "SET" and the highlight will shift to the DIAMETER column of Tool # 1. (Note that you may not be interested in setting up Tool #1 if it is not one of the active tools of the program. If this is the case, use the DATA softkeys to move to a tool you are interested in.)
6. Input the diameter for the tool and press SET.
7. The highlight will move to the Z OFFSET column. Put this tool in the spindle and touch it to the same surface as you used to touch the reference tool in Step 2 above.
8. Press set.
9. The highlight moves to the Z Modifier column. Input a Z modifier if you wish (see below) or simply press SET again for the highlight to move to the DIAMETER column of the next tool.
10. Repeat steps 5 to 8 for each of the tools you want to set up. Remember to touch the same surface you used to set the reference tool.

Once the reference position is set, you will not be able to move the highlight back to the word "SET".

*Note: You must set absolute zero reference in the DRO Mode before machining the part. You may use any tool that you have set up with the above procedure to set your reference and the ProtoTRAK will automatically compensate for the difference in length for the rest of the tools.*

### 12.1.5 Starting Over: Erasing Tool Information

There will be times when you don't completely trust the information that is in the tool table. For example, perhaps you have loaded in a program that you wrote a month ago and you recall that one of the tools you used was held in a chuck. In that case, you probably want to erase the table and start over.

In order to do this, simply press the ERASE TABLE softkey and answer yes to the prompt. All the data in the tool table will be erased including the reference. The numbers of the tools used in any program in current memory will still be red.

### 12.1.6 Adding a Tool

When the reference is SET and the original touch-off surface is still available, you can add a tool very easily:

1. First make the tool number active by using it in the program in current memory.
2. Put the new tool in the spindle.
3. Go to the Set-Up Mode, tool table
4. Enter the diameter.
5. Touch the new tool to the same surface as the reference.
6. Press SET.

If the surface is not available, it will be necessary to establish a new reference before adding the new tool. See Section 12.1.9 below. Once the reference is reset, use the procedure above on the new surface used to set the reference.

### 12.1.7 Replacing a Tool

If you need to replace a tool that was not used as the reference, simply do the following:

1. Put the replacement tool in the spindle.
2. Put the highlight in the correct row for the tool number.

3. Reenter the diameter if different.
4. Touch the tool to the same surface that was used to touch off the reference.
5. With the highlight in the Z OFFSET column for the correct tool number, press SET.

If you need to replace a tool that was used as a reference, we recommend that you press the ERASE TABLE softkey and start all over again. (Not to nag, but that is why it is a good idea to have a separate reference setting tool and use a constant reference surface. If you work with programs that use a lot of tools, this practice can really save time.)

### 12.1.8 Z Modifiers

Z modifiers make it easy to adjust the depth of cut of particular tools without having to change programmed Z end dimensions or change the tool offsets.

For example, say an end mill was under cutting the depth of a part by .003". An easy way to correct this is to enter a Z modifier.

1. Highlight the number in the Z MODIFIER column in the row for the correct tool.
2. Enter the amount of the adjustment you wish to make. To cut deeper, enter a negative number. To cut shallower, enter a positive number. In the example above, to correct this undercut, we would enter -.003.
3. Press SET.

The ProtoTRAK SM CNC will apply this modifier each time this tool is used.

### 12.1.9 Resetting the Reference Point

Once the reference reads SET, you are not allowed to highlight and reset it. If you need to reset the reference, there are two ways to change the reference to NOT SET. You can erase the table (and lose all the tool information) or load in a program.

### 12.1.10 Saving Tool Information

Tool information is saved with the program. If you have made changes to the program or to the tool table that you wish to keep, you must save, or store, the program in the Program In/Out Mode.

### 12.1.11 Opening a Program

When you open a program, the tool information that is saved with the program will be loaded into the tool table. The numbers for the tools that are used in the program are in red. The diameters, Z Offsets and Z modifiers that were saved with the program will overwrite any information that was in the tool table before the program was opened. If these tools were not set very recently, we recommend that you check them before running the program.

The Ref row will read "NOT SET". A reference may be set at this point.

If you do not go into the tool table after opening a program and before running, you will get a reminder message to check your tools.

### 12.1.12 Making Tool Set-Ups Easy

We highly recommend the following to make tool set-ups easy.

1. Always use the same tool to set your reference. Preferably, you should use a tool you don't use to machine, something that you keep in your toolbox.
2. Don't use a tool that you use to machine your part as a reference. If your reference tool breaks, you have to reset all your tools.
3. Always use the same surface for touching your tools to. Use the machine table, a gage block or the vice, something you can always count on being there. If you use the top of the part, your reference is changing all the time.

### 12.1.13 The Tool Table and Two-Axis CNC Operation

The information entered in the tool table will also be used when operating the ProtoTRAK SM CNC as a two-axis CNC. Instead of positioning the head, the DRO information seen in the Run Mode will be adjusted for the differences in tools. When a new tool is loaded, the Z dimension will change according to the offsets in the tool table. This change will occur when the GO key is pressed after the "Load Tool # \_\_\_" prompt.

## 12.2 Tool Path

When the TOOL PATH soft key is pressed, the program is processed and the tool path graphics are displayed.

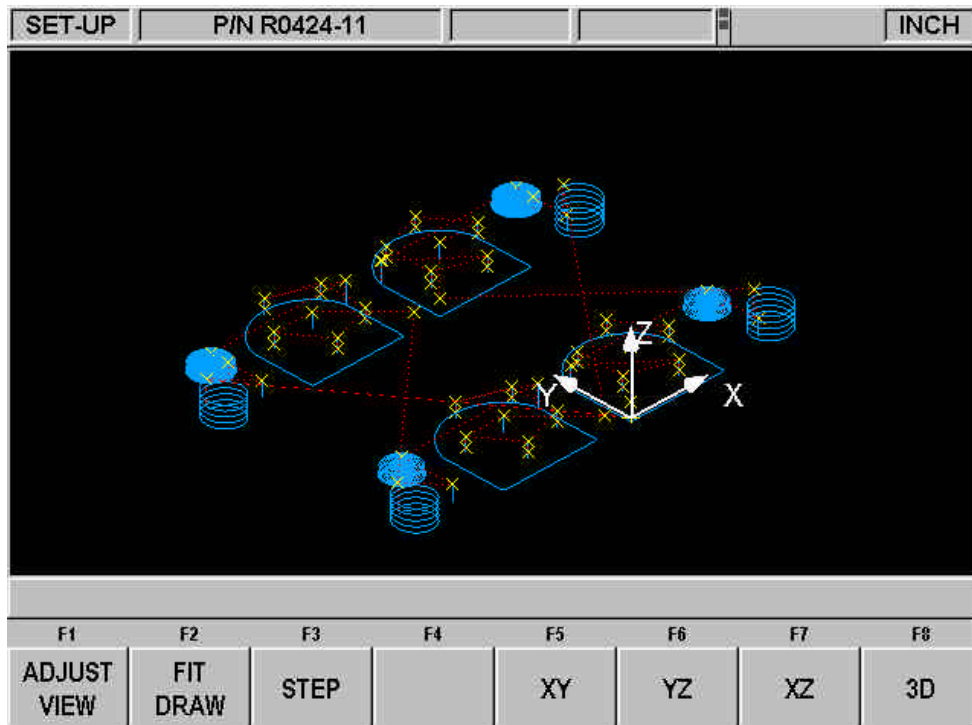

**FIGURE 12.2** The Tool Path graphics show the program and tool positions

Most programming errors that would prevent the program from running are detected when the tool path graphics are selected. For example, if you were to have omitted a

minus sign from a Z End dimension, the system would give you an error message that the Z End should not be higher than the Z Rapid.

The displayed graphic is automatically sized to fit the screen and an icon that represents the X, Y and Z orientation is placed at the program's absolute 0 reference point. The path shown on the screen represents the center of the tool.

- Position and drill events are drawn in yellow.
- Rapid moves are in red.
- Programmed geometry is in blue.

### 12.2.1 Soft keys in Tool Path

**ADJUST VIEW:** calls up additional softkeys to adjust the view. See below.

**FIT DRAW:** will re-draw, automatically sizing to fit the screen (necessary only if an adjustment changed the drawing from its initial sizing).

**STEP:** each press of the STEP button shows the next tool move. You may hold the STEP button down to draw the graphic without repeated button presses. To complete the drawing automatically, press FIT DRAW.

**XY, YZ, XZ, 3D:** shows the same drawing on the screen, with adjustments, in the view you select. Soft keys in ADJUST VIEW:

**FIT:** same as the FIT DRAW.

▼ ▲ ◀ ▶ : moves the drawing in that direction.

**ZOOM IN, ZOOM OUT:** resizes the drawing.

**RETURN:** returns to the previous soft keys, retaining the adjustments that were made to the drawing.

## 12.3 Reference Positions (REF POSN)

The Reference Positions screen shows the retract status, the home locations and software limits for all axes.

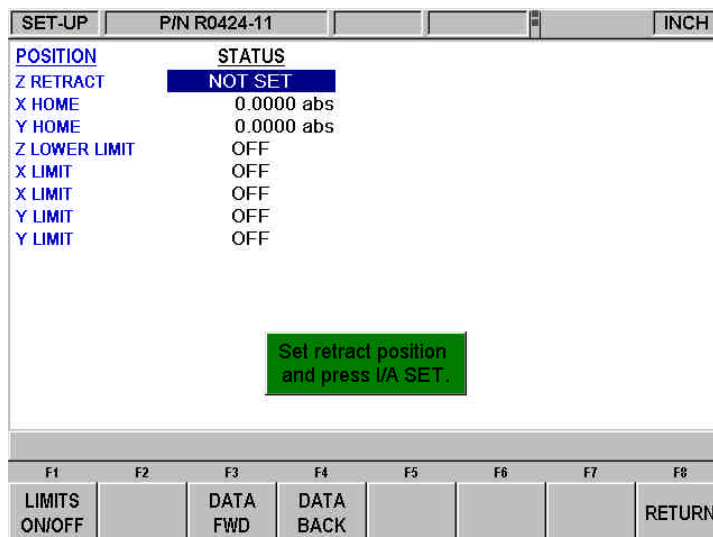

**FIGURE 12.3** Reference positions. The Z Retract is not set. Position the head and press a SET key

### 12.3.1 Z Retract (three-axis CNC)

The Z Retract is where the quill will go for a tool change or at the end of running a program. Programs may not be run in three-axis CNC until the Z Retract is set. Since the Z-axis (quill) is operated manually in two-axis CNC, it is not necessary to set the Z retract to run a two-axis CNC part.

As a general rule, always set your Z retract so that your longest tool is above the set-up.

When you first enter the Reference Positions screen, the Z Retract will show "NOT SET" and the message window will instruct you to move the ram to the desired retract position and then press SET. You may have to go into the DRO Mode to move the ram to where you want it and then return to the Reference Positions screen to set this position.

### 12.3.2 Home Positions

X and Y home positions are where the table and saddle go when there is a tool change or at the end of the program. These dimensions must always be from absolute zero. Note Z home is the same as Z Retract.

### 12.3.3 Limit Positions

X and Y limit positions (one for plus direction, one for minus) will stop the program if they are exceeded during run. Note that pressing the **LIMIT ON/OFF** soft key will turn the prompted limit off, or back on to its input value. If the limits are turned on, your program and home positions must fit within the limits you define. If you turn on the limits and leave them at the default of 0 Absolute, the program will not run.

## 12.4 Fixture Offsets

Fixture offsets are entered in the Set-Up Mode. From the screen in Figure 11.0, press the Fix Offset key. The following screen will result.

SET-UP				3 AXIS	INCH		
<b>FIXTURE #</b>	<b>X OFFSET</b>	<b>Y OFFSET</b>	<b>Z OFFSET</b>				
1	BASE	BASE	BASE				
2	8.1230	0.1160	0.0000				
3	0.0000	0.0000	0.0000				
4	0.0000	0.0000	0.0000				
5	0.0000	0.0000	0.0000				
6	0.0000	0.0000	0.0000				
X	0.0000	ABS					
Y	0.0000	ABS					
Z	0.0000	ABS					
X OFFSET FROM FIXTURE 1 TO 3 :				0.0000			
F1	F2	F3	F4	F5	F6	F7	F8
DATA DOWN	DATA UP	DATA LEFT	DATA RIGHT		ERASE TABLE	JOG	RETURN

*Figure 12.4 The Fixture Offset screen.*

Setting up fixtures is easy. First, establish your base by setting your X, Y and Z absolute zero. You can do this in the DRO Mode, but the X, Y and Z Absolute position dimensions are also on this screen for your reference. Fixture #1 is always the base.

Once you set your absolute zero on the base, it is simple a matter of entering the distance from the base to up to five other fixture locations. You can do this one of two ways. By entering the numbers with the keypad or by positioning to the next fixture, putting the cursor on the correct offset value, and then pressing ABS SET.

## 12.5 Service Codes

These are special codes that may be entered into the ProtoTRAK SM CNC to call up routines used in installation, setting of preferences, machine checkout and service.

The following is a summary of the service codes available.

**WARNING!**  
Before using service codes, be aware that some of the routines are very powerful and may change system settings in a way you don't want. Some of the routines cause the servos to come on and move at rapid speed.

Category	Service Code	Comments
Software	33 software and firmware version	Displays current software versions and system settings.
	141 load EEPROM file	To load in set-up values from a disk in the floppy drive
	142 save EEPROM file	To set-up values to a file on a floppy drive
	316 software update – master	Use with floppy disk
	317 software update – slave	
	318 converter activation	
	37 RS232 Baud rate	To set for RS232 communication
	232 RS232 com port	Change default
Machine set-up	123 sensor calibration	
	132 handwheel test	
	100 open loop test	<b>DANGER!</b> The machine will move!
	129 arc accuracy setting	To enter the preference. Default is .001
	304 toggle X glass scale or TRAK sensor on or off	Run the machine from the motor encoders in case of table scale or sensor failure.
	304 toggle Y glass scale or TRAK sensor on or off	Run the machine from the motor encoders in case of saddle scale or sensor failure.
Servo calibration	128 backlash calibration constant	
	127 auto backlash configuration	
	11 backlash hysteresis test	
	12 feed forward constant	<b>CAUTION!</b> The servo parameters may change.
Service code number	None	Shortcut to entering the service code when you know it





# 13.0 RUN MODE

## 13.1 Run Mode Screen

Press **MODE** and select the **RUN** soft key. The display will show:

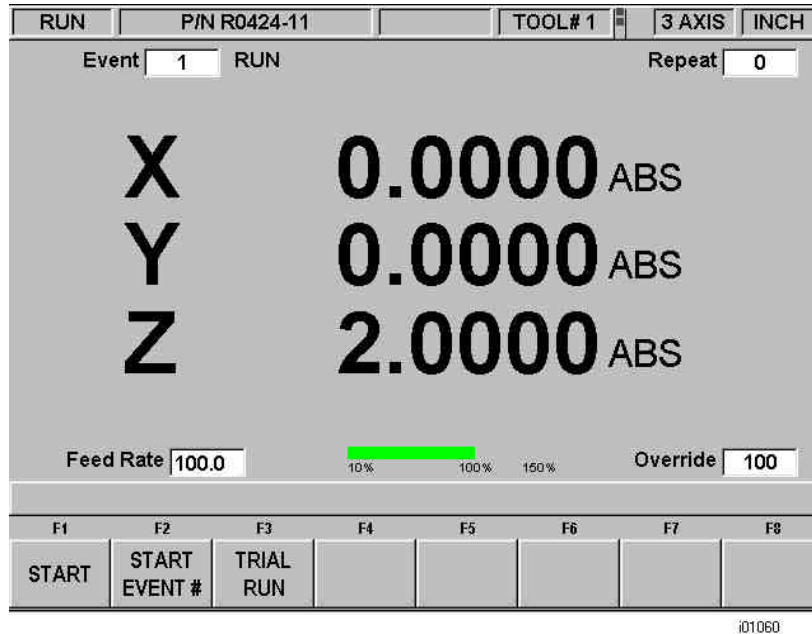

**FIGURE 13.1** The Run Mode. The ProtoTRAK SM CNC awaits your instructions for how to begin machining Part Number R0424-11

Items on the Run Screen:

**Event counter:** this will be the current event number and event type.

**Repeat:** if a repeat event is in the event counter, this will show which repeat number, for example, if you program a drill with 5 repeats, this will show which repeat of the event that is being machined.

**Feed Rate:** programmed feedrate of the current move as adjusted by the feed override.

**Green bar:** graphical representation of the feed override

**Override:** % of feed override.

## 13.2 Two Versus Three-Axis Running

The three-axis run will control all three axes; the two-axis will control the X and Y (table and saddle) only, with you manually positioning the Z (head).

Most differences that occur as a consequence of either two or three-axis operation are obvious. Two issues are worth noting:

1. The way the tool table works between two and three-axis operation. See Section 12.1
2. Positioning of the quill is automatic in the 3-axis CNC, but in two-axis, the ProtoTRAK SM CNC will prompt "Check Z" before a rapid move and "Set Z" for you to position the cutter to machine the part.

### 13.3 Starting to Run

Before running a part, you must establish the position relationship between the part and quill. That is, you need to identify where the part is on the table relative to the tool or quill centerline.

This is done by using an edge finder or dial indicator to move the table so that the part program absolute zero is under the quill centerline. **ABS SET** this position as absolute zero in the DRO mode. In addition, load the tool for Event 1 and position it at Z absolute zero. If this is impossible, position the tool some known distance above absolute zero and **ABS SET** this dimension.

The program may be started in the two ways identified as soft keys in the screen in Section 13.1

Pressing the **START** soft key begins the program at Event 1 and assumes that the absolute zero that was last set in the DRO mode corresponds to the part program zero. That is, if you were in the DRO mode and you moved the table to X=0 ABS, and Y=0 ABS the part program zero would be directly under the quill centerline.

Pressing the **START EVNT #** soft key allows you to start in the middle of a program. When you press the **START EVNT #** soft key, the conversation line will prompt "Input Event #." Input the number of the first event you wish to run, and press **SET**. If the **START EVNT #** is a Repeat or Rotate, the conversation line will prompt "Starting Repeat Number" asking which repeat or pass you wish to start.

### 13.4 Program Run

When you have started by any of the means above, the display will show:



**FIGURE 13.4** Press the GO feed key to start running.

Where:

The part number being run is shown in the status line.

- A "S/F" message will appear in the status line when the Scale Factor is not set at 1.0000
- The event number and type (and the repeat number, if applicable) being run is shown at the top of the screen.
- The current X, Y, Z absolute positions are shown in the information area.
- The **SHOW ABS** soft key (which is automatically assumed if one of the other 3 show keys are not selected) will show the absolute X, Y, Z positions as the part is run.
- The **SHOW INC** soft key will show the incremental (or distance to go within the event) X, Y, Z positions as the part is run.
- The **SHOW PATH** soft key will show the tool path graphics as the part is run.
- The **SHOW PROG** soft key will show the programmed data for the event being run, and the next event as the part is run.

The run procedure is very simple. Follow the instructions on the conversation line and proceed by pressing the GO key.

Once the STOP hard key is pressed, additional softkeys will be available:

### 13.5 Program Run Messages

During Program Run, all messages that will help you to run the part will appear in the data input line. The messages you will usually see are:

**Load Tool** \_\_ \_\_: Means to load the tool requested and press **GO** to continue.

### 13.6 Stop

At any time, the program may be halted by pressing the **STOP** key. This freezes the program at that point. You may choose to continue running the program by pressing the CNC RUN softkey or pressing the **GO** key. You may also run the program by using the table or saddle handwheels by pressing the TRAKing softkey.

### 13.7 Feedrate Override

The run feedrate may be changed at any time by pressing the **FEED** **↑** or **FEED** **↓** keys. Each press modifies the programmed feedrate, as well as rapid by 10%.

### 13.8 Trial Run

Trial Run allows you to quickly check out your program with no Z movement before you actually start to make parts. In trial run the table will move at rapid speed regardless of what feedrates are programmed (the rapid speed may be overridden with **FEED** **↑** and **FEED** **↓** keys). The table will stop at each "stop" location (for example, at each drill location) but immediately continue on without your input.

To do a trial run, press the **TRIAL RUN** soft key from the screen shown in Section 13.1. The message box will read "Ready to begin trial run. Press GO to start." Be certain the table is positioned so that if it moves through the part program, it will not reach its travel limit. Also check that the quill is fully retracted. Press **GO** to begin.

## 13.9 Data Errors

In order to run, a program must make sense geometrically. For example, you can't machine a .250-inch diameter circular pocket using a .500-inch end mill.

Data errors will nearly always be detected when the ProtoTRAK SM CNC runs through a program--either as a Trial Run or on an actual part run. They may also be detected in the Set Up mode when using the Tool Path Graphics routines.

Whenever the ProtoTRAK SM CNC detects a data error a message will appear that will tell you the error number (you may wish to record this number for troubleshooting purposes) and the event where the error was detected. This is not necessarily the event that is in error since the system often "looks ahead" to make sure there is compatibility from one event to another.

In addition, an explanation is given for each data error type as well as a suggested solution. Press the **RETURN** soft key to go back to the Select Mode screen, correct your error, and proceed.

## 13.10 Fault Messages

The ProtoTRAK SM CNC performs a number of automatic checks or self-diagnostics. If problems are found a message will appear: "Fault \_\_\_ \_\_\_ \_\_\_". The information area will display an explanation and suggested solution.

## 14.0 Program In/Out Mode

From the Select Mode screen, press the PROG IN/OUT softkey. The first screen you see will ask:

"LIST SUPPORTED PROGRAMS ONLY?"

With a highlighted YES or NO.

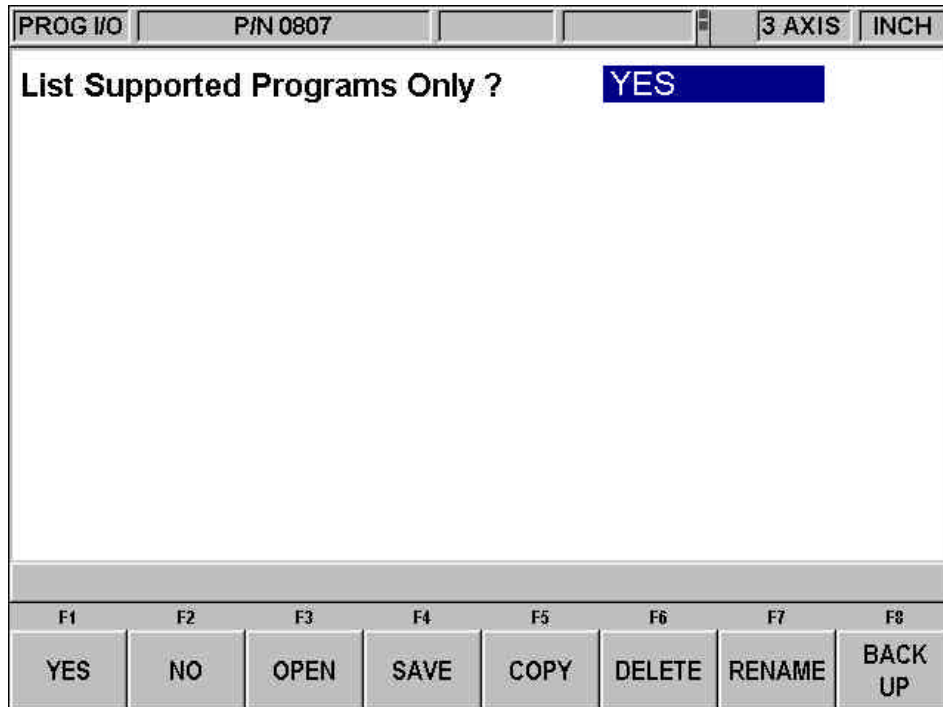

**FIGURE 14.0** Supported programs are part programs that can run on the ProtoTRAK SM CNC. You do not have to answer this question every time you are at this screen. Simply press the softkey for the operation you want.

Supported programs are the programs that will run on your ProtoTRAK SM CNC. It is possible to view other types of files through the Program In/Out Mode, for example, Microsoft Word® files. This type of file is not supported on the ProtoTRAK SM CNC in the sense that you cannot open it and work on it. We recommend a "Yes" response to this prompt. If "No" is selected, it is possible to view, and inadvertently damage, files that are critical to running the ProtoTRAK SM CNC (as well as on other networked computers.)

### Filenames and File Extensions

Most places in the ProtoTRAK SM CNC, we refer to the program or part. In Program In/Out Mode, this program or part is called a file. Filenames are program names or part names. They are the name you give to the programs you write on the ProtoTRAK SM CNC, plus a file extension. Although the ProtoTRAK SM CNC can have program names up to 25 characters that use letters and special symbols, most other CNC's must have file names that are eight or fewer characters using numbers only.

File extensions are part of filenames that help describe the file. They appear after the filename and are composed of three letters following a period. For example, .doc is the extension that appears after a file name for a file stored using Microsoft Word™.

Usually, but not always, the file name indicates what program was used to create the file. Sometimes this is not the case. Some programs, like those found in early models of CNC, do not attach a file extension to a file name at all. Also, a user may attach his own extension to a file name for his own purposes.

ProtoTRAK and TRAK A.G.E. CNC's always attach an extension to every file that is stored. The extension .mx2 is used for files, or programs, (written and) stored on a ProtoTRAK MX2, ProtoTRAK M2 or TRAK A.G.E. 2 CNC. The extension .mx3 is used for the ProtoTRAK MX3, ProtoTRAK M3 and TRAK A.G.E. 3 CNC's. The ProtoTRAK SM CNC uses the extension .PT4, whether the program is two or three-axis. (Before opening the file, the ProtoTRAK SM CNC is able to determine what kind of file it is.)

A file extension that is unique to the ProtoTRAK SM CNC is .GCD. The .GCD extension tells the ProtoTRAK SM CNC that a particular program is a standard RS274, or G Code program. When you specify this extension, the ProtoTRAK SM CNC will treat that program in a special way. This is explained in Section 14.9.2.

## 14.1 Softkey Selections in the Program In/Out Mode

**YES:** to display only supported programs.

**NO:** to display all files.

**OPEN:** to bring a program from storage into the current memory.

**SAVE:** to save the program that is in current memory to storage.

**COPY:** to select and make a copy of a file in storage for pasting in another storage location.

**DELETE:** to remove a file from a storage location without altering the current memory.

**RENAME:** to rename a file or folder.

**BACK UP:** to perform a convenient back up of program files to another storage location.

## 14.2 Basic Navigation of Program In/Out Mode Screens

The screens in the Program In/Out Mode do not have the normal ProtoTRAK look and feel because they are derived from the Windows operating system. Most functions may be performed using a mouse or keyboard. Softkeys are provided to operate the system through the control's keys.

### 14.2.1 Basic Parts of the Program In/Out Mode Screens

The status line at the top of the screen will display:

- The mode
- The program name for the program in current memory (if any).
- Whether the ProtoTRAK SM CNC is in two or three axis.

The **Look In** area shows the storage areas (or drives) and directories that are being displayed below in the listing area.

In the listing area (the biggest part of the screen) appears all the files and folders for the location shown in the **Look In** box. The C drive of the ProtoTRAK SM CNC is not accessible for program storage.

The File Name box shows the program file on which the operation will be performed.

Parts of the screen unique to specific operations will be discussed below.

## 14.2.2 Softkeys in the Program In/Out Mode Screens

Use the softkeys to move around any of the screens in the Program In/Out Mode:

**TAB:** Moves the highlight between the parts of the screen. Where applicable, tabbing to an area will cause a drop-down box to appear, showing all the selections possible.

**DATA FWD, DATA BACK:** Moves the highlight up and down through the list. Press and hold for automatic advancement.

**OPEN FOLDER:** Use this key to open a highlighted folder that contains program files. When the highlight is on the root directory, this will collapse the list displayed and show the next level up. The root directory is represented by a folder with an up arrow followed by two periods. The root directory will disappear when the most basic organization for the drive in the Look In box is reached.

## 14.3 Opening a File

To open a program file from a storage location, press the OPEN softkey from the Program In/Out Mode screen. The ProtoTRAK SM CNC will always default to the last folder you had open.

Find the file using the softkeys as described above in the section on basic navigation.

In addition to the basic parts of the screen described above, two additional parts of the screen appear in the open operation:

**File Name:** displays the name of the file that is highlighted from the list.

**Open As:** lists the formats for which the file may be opened. The default is .PT4.

Two additional softkeys appear:

**OPEN FILE:** Opens the highlighted program file and puts it in current memory. Only one file may be in current memory at a time, if one is there already, a warning message will appear before that file is overwritten.

**RETURN:** Returns to the Program In/Out Mode screen.

When the open operation is finished, the system will return to the Select Mode screen.

## 14.4 Saving Programs

To save a program file to a storage location, press the SAVE softkey from the Program In/Out Mode screen.

Find the drive and folder you want to save the program file in using the softkeys as described above in the section on basic navigation.

Three additional parts of the screen appear once the SAVE softkey is pressed:



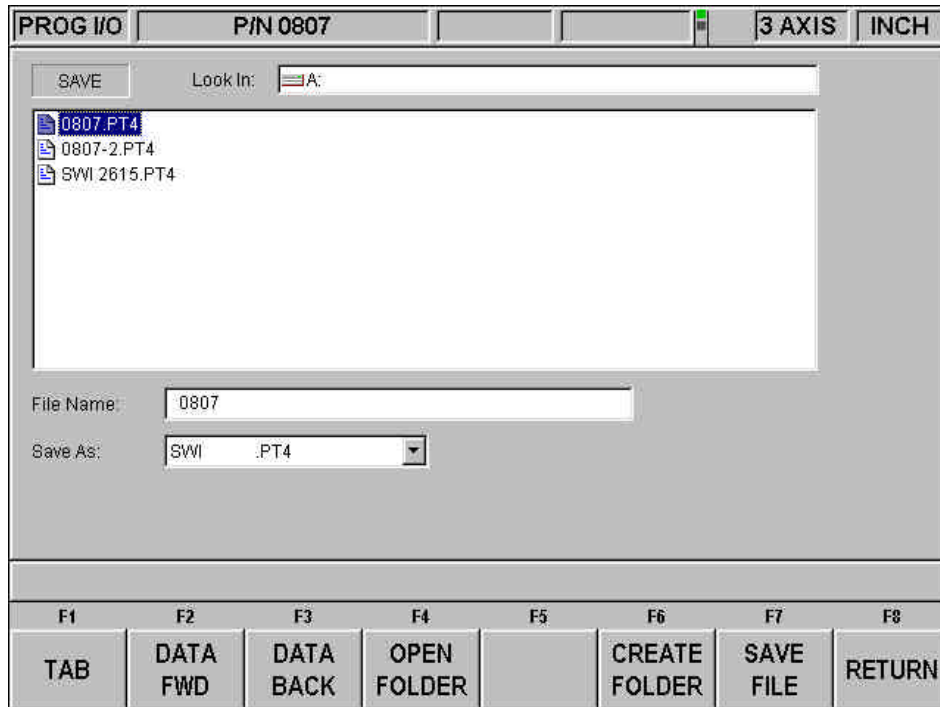

**FIGURE 14.4** *The Save screen*

**File Name:** displays the name of the file that is in current memory.

**Save As:** lists the formats for which the file may be saved. The default is .PT4.

Three additional softkeys appear:

**CREATE FOLDER:** Use this to create a new folder for the program file. This new folder will be added to the list shown in the listing area, at the same level of organization as the files and folders shown. Once the CREATE FOLDER softkey is pressed, a Data Input Line will appear for entering the name of the folder. The name "Folder1" will be written in the box. To accept this name, press SET. You may input a name you select by writing over this name. Use the same procedure for naming a program (see Section 7.3.1).

**SAVE FILE:** Saves the program file to the location shown in the Look In area.

**RETURN:** Returns to the Program In/Out Mode screen.

Once the save operation is finished, you will see the file name added to the files in the listing area.

## 14.5 Copying Programs

To copy a program file from one storage location to another, press the COPY softkey from the Program In/Out Mode screen. Only one file may be copied at a time using this operation. To copy multiple files or folders, see Section 14.8.

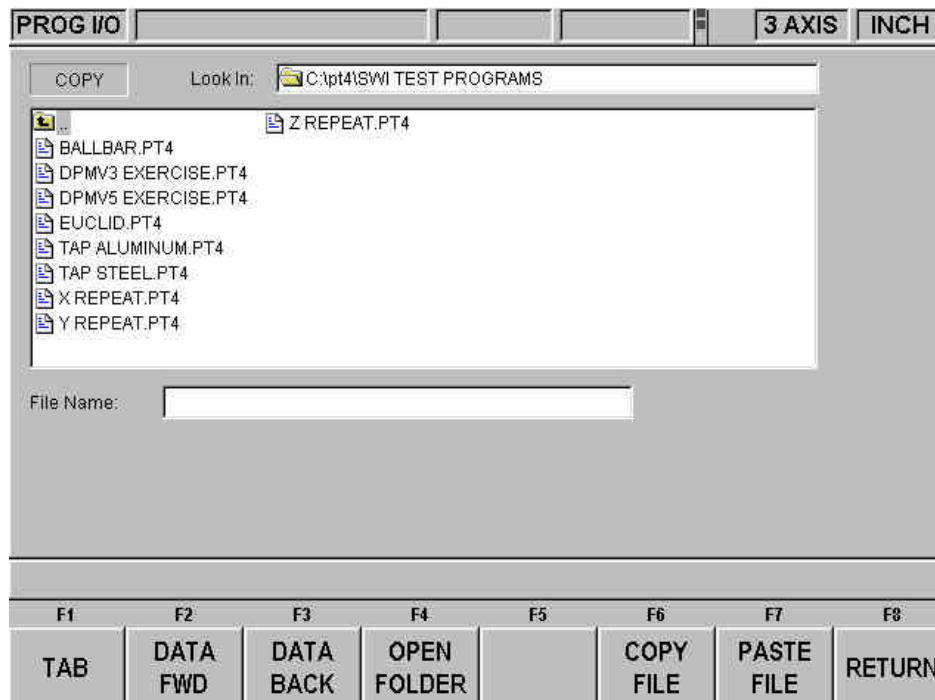

**FIGURE 14.5** *The Copy screen*

The copy operation is in two parts. First, use the navigation procedure described in Section 14.2 above and highlight the program you wish to copy. Press the COPY FILE softkey to copy the file. Then go to the new file or drive, open it using the Open Folder softkey and press Paste file. Once the file has been copied, it can be pasted to as many other locations as you want.

Additional softkeys in COPY:

**COPY FILE:** Makes a copy of the highlighted file.

**PASTE FILE:** Writes a copy of the file to the location shown in the Look In box.

**RETURN:** Returns to the Program In/Out Mode screen.

When the pasting operation is finished, you will see the file name added to the listing area.

## 14.6 Deleting Programs

Programs in current memory are removed from current memory in Edit Mode. See Section 11.3

To remove a program file from a storage location, press the DELETE softkey from the Program In/Out Mode screen.

Use the navigation procedure described in Section 14.2 above and highlight the program file or folder you wish to delete. Press the DELETE FILE or DELETE FOLDER softkey. A warning message will appear for confirmation.

Additional Softkeys in DELETE:

**DELETE FILE:** Press this to delete a file.

**DELETE FOLDER:** Press this to delete a folder.

Softkeys that appear with the confirmation message:

**YES:** Press this if you want to delete.

**NO:** Press this if you do not want to delete. The delete operation will be aborted and the previous softkey selections will return.

When the delete operation is finished, the file or folder name will disappear from the listing area.

## 14.7 Renaming

To rename either a file or a folder, press the RENAME softkey from the Program In/Out Mode screen.

To rename a file or folder:

1. Use the navigation procedure described in Section 14.2 above and highlight the program file or folder you wish to rename.
2. TAB to the New Name area and enter a new name. Use the same procedure as for naming a program (see Section 7.3.1).
3. TAB to the New Extension and enter a new extension.
4. Press either RENAME FILE or RENAME FOLDER.

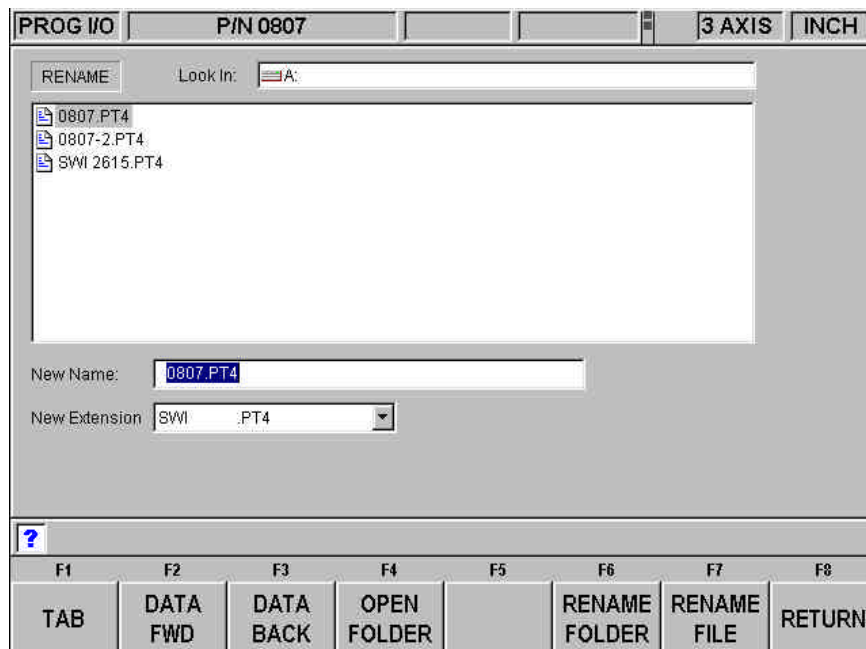

**FIGURE 14.7** Renaming a file. Press the Help hard key to call up the alpha keys

Additional parts of the screen appear once the RENAME softkey is pressed:

**New Name:** When a file or folder is highlighted, the name will appear here. When the TAB, the RENAME FILE or RENAME FOLDER softkey is pressed, the highlight will move here and you will then be able to write in a new name.

**New Extension:** A new extension can be given to the file picking from the ones available. If the file name already contains an extension, you will have to erase the old one before giving it a new one.

Additional softkeys:

**RENAME FOLDER** - Press once a new name has been entered into the New Name and New Extension areas to change the name of the folder.

**RENAME FILE**- Press once a new name has been entered into the New Name and New Extension areas to change the name of the file.

**RETURN** - Returns to the Program In/Out Mode screen.

## 14.8 Backing Up

In order to protect your important programs, it is a good idea to back them up regularly. That way, if a floppy disk or hard drive becomes unusable, you will not have to re-write the program.

To back up your files, press the BACK UP softkey from the Program In/Out Mode screen.

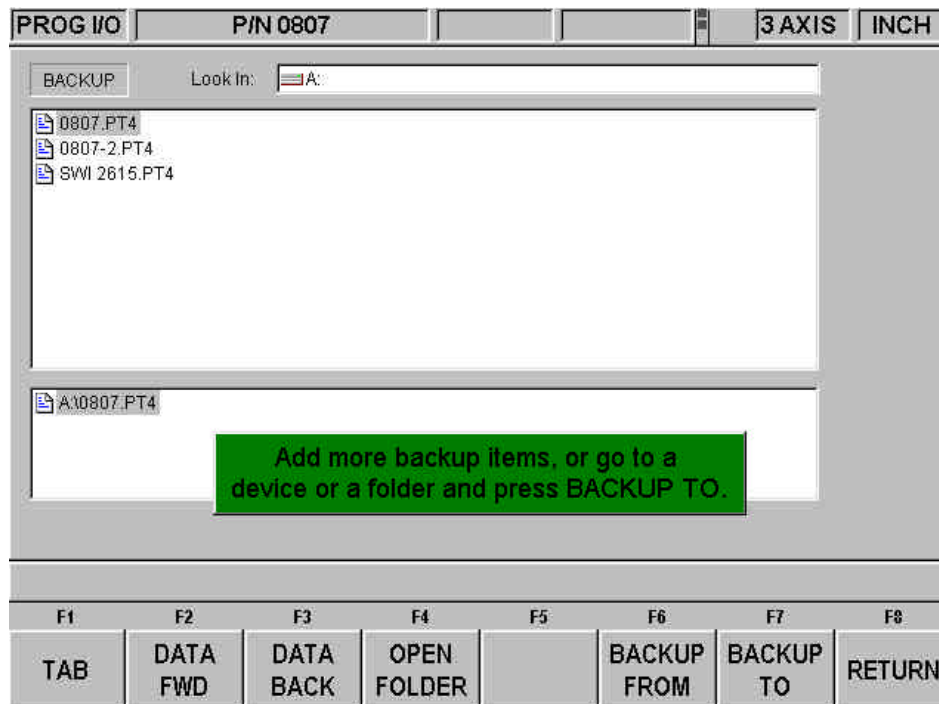

**FIGURE 14.8** *Backing up. The top part of the screen shows all the items in Drive A. The bottom part shows the items that have been picked for backing up*

The basic procedure for backing up is:

1. Use the navigation procedure described in Section 14.2 above and highlight the program file or folder you wish to back up.
2. Press the BACKUP FROM softkey. You will see the item appear, along with its directory path, in the new listing area under the main listing area.
3. Repeat the above for as many items as you wish.

4. Use the navigation procedure to select a different drive or a different folder.
5. Open the drive or folder using the Open folder key.
6. Press BACKUP TO.

When the back up operation is completed, you will see the items and their directories in the new location.

*Note: You must set an absolute zero reference in the DRO Mode before machining the part. You may use any tool that you have set up with the above procedure to set your reference and the ProtoTRAK will automatically compensate for the difference in the rest of the tools.*

## 14.9 Converters™

Converters are programs within the ProtoTRAK SM CNC that translate CNC program files of another format into a ProtoTRAK SM CNC file, or a ProtoTRAK SM CNC file into a different format. With converters, you can run programs written on the ProtoTRAK SM CNC on a machine that does not have a ProtoTRAK SM CNC and vice versa.

Each ProtoTRAK SM CNC comes with converters for other ProtoTRAK and TRAK CNC's. Converters for other brands of CNC's are sold separately.

Program conversions take place by first translating the file into a neutral run engine, then from neutral to the desired file format. For this reason, you should think of conversions as being only one way. The conversion process changes the file in ways that are harmless and so the results are correct. However, when converted back, it will not be the same as it was originally written; it will create the same part, but some of the lines of code will be different.

### 14.9.1 Activating Converters

Converters must be activated before you can use them. Standard converters include those that handle the translation between the ProtoTRAK SM CNC and other TRAK CNC's. Optional converters are purchased separately. Standard converters and optional converters that are ordered and shipped with the machine are activated at the factory.

You can tell which converters are activated by looking in the Open As (see Figure 14.9.3) or Save As windows (see Figure 14.4).

If you purchase a converter after you have installed your machine, you must activate it yourself using a simple procedure:

1. Go to Set Up Mode, Service Codes, then A. Software.
2. Press the soft key for Service Code 318.
3. A screen will appear that lists all the converters available for the version of ProtoTRAK SM CNC software that you have. The converters that are active are listed in black; the inactive converters are grayed out. See Figure 14.9.1.
4. Place the cursor over the inactive converter you want.
5. Press the Install soft key.
6. There is a password that enables you to use the converter. Enter the password in the Data Input Line and press Set. If you do not have the password, call the SWI Customer Service Group at (800) 367-3165. You will need to make arrangements to pay the fee for the converter before you are given the password.

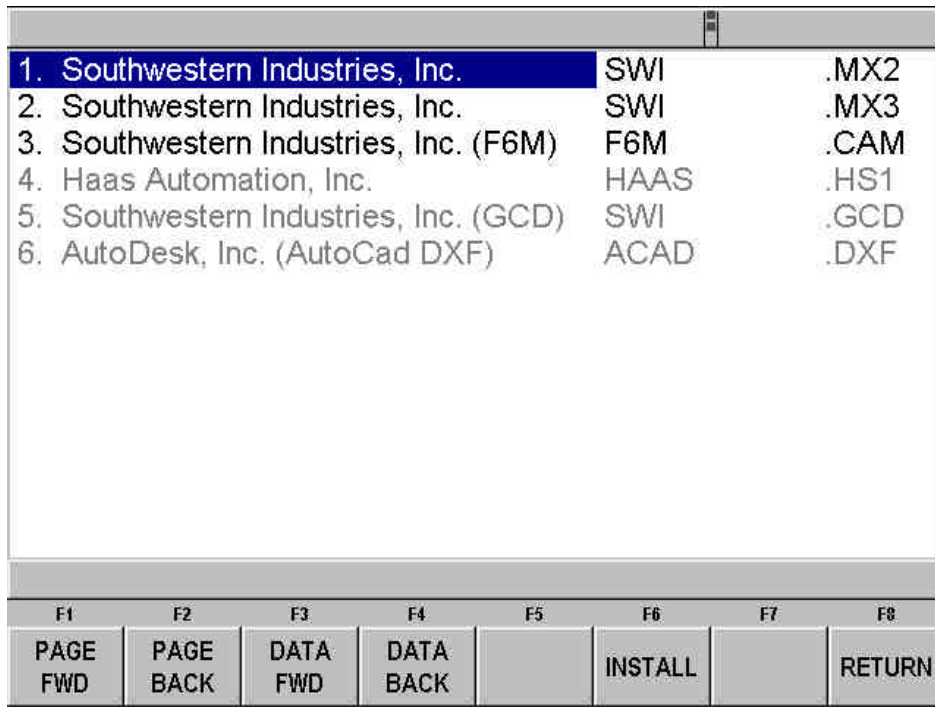

i01056

**FIGURE 14.9.1** Service Code 318 displays a list of converters available on the ProtoTRAK SM CNC software version you are running. On this list, the first three converters are active, the rest are not active.

#### 14.9.2 Converting From a Different Format into a ProtoTRAK SM CNC

Conversions from a different format into a ProtoTRAK SM CNC occur when the file is opened.

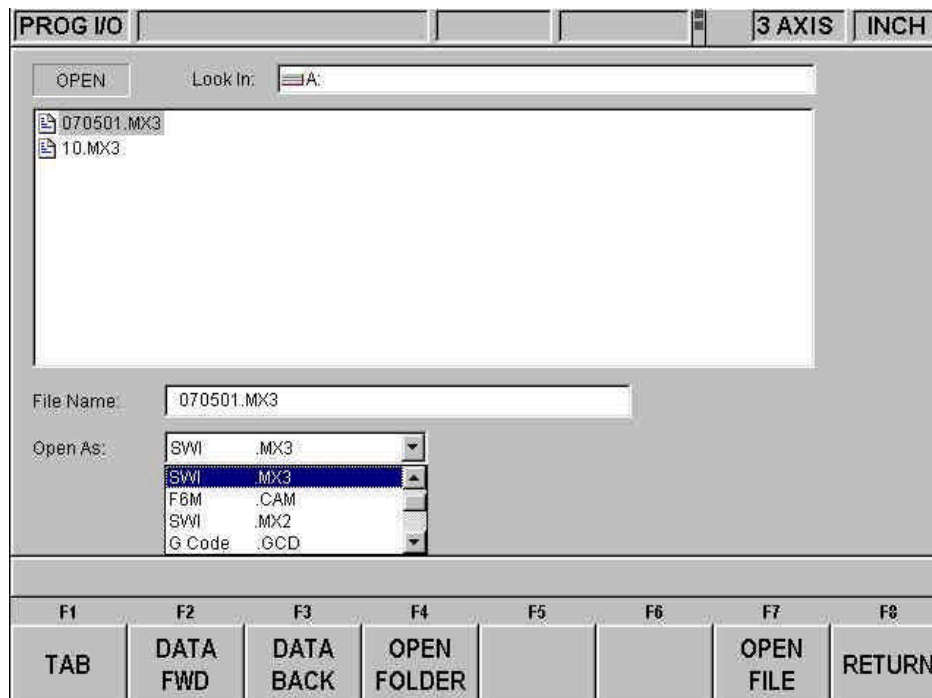

**FIGURE 14.9.2** Use the Open As box to tell the ProtoTRAK SM CNC what kind of file it is

Use the Open As box to tell the ProtoTRAK SM CNC what format the file is in so that it knows how to convert it to the ProtoTRAK SM CNC format. In Figure 14.9.1 the ProtoTRAK SM CNC could guess that the file to be converted was from a previous version of ProtoTRAK because of its file extension (.mx3). But since file extensions may be missing or may not really describe the file format correctly, you can use the Open As box to declare the file type.

All files, or programs, open on the ProtoTRAK SM CNC as a .PT4 file (with one exception, G-Code files, see below). Once the file is opened as ProtoTRAK SM CNC file, you may store it as ProtoTRAK SM CNC file with the same filename and the extension .PT4.

The drop-down menu in the Open As box shows which converters are available. Open As types that are grayed out indicate converters that are available for purchase.

### 14.9.3 Converting From the ProtoTRAK SM CNC to a Different Format

Files, or programs, are converted from the ProtoTRAK SM CNC to a different format using the Save function of Program In/Out Mode.

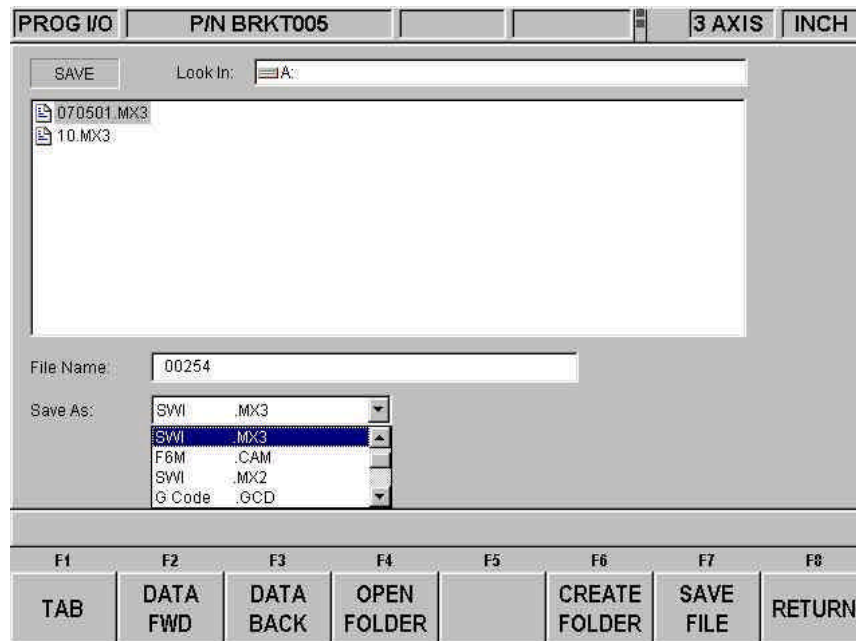

**FIGURE 14.9.3** Use the Save As box to tell the ProtoTRAK SM CNC what file format you want to end up with

Use the Save As box to tell the ProtoTRAK SM CNC what kind of file you want the current program (in the .PT4 format) to be converted into.

In Figure 14.9.3 the file name 070501 is being saved on drive A as a .mx3 file. Note that although the program or part name as shown in the status line is BRKT005, the file name given for converting the file conforms to the .mx3 format – fewer than eight characters long and consisting of numbers.

## 14.10 ProtoTRAK and TRAK CNC Compatibility

File exchange between the ProtoTRAK SM CNC and other ProtoTRAK and TRAK CNC's is possible because the ProtoTRAK SM CNC is backward compatible. In other words, the ProtoTRAK SM CNC can store and retrieve other ProtoTRAK and TRAK CNC files. The actual transfer of the files can be accomplished by using a floppy disk, zip disk, RS232 and/or Ethernet cable. In order to

transfer files between the ProtoTRAK SM CNC and previous generations of ProtoTRAK and TRAK CNC, you must have the .MX2 and .MX3 converters activated. See Section 14.9 above.

**Note:** Previous ProtoTRAK and TRAK CNC's allow numeric filenames of eight (8) characters or less, while the ProtoTRAK SM CNC allow alphanumeric filenames (letters and numbers) of up to twenty five (25) characters. Be sure to use only numeric filenames when storing a file on a ProtoTRAK SM CNC that will be retrieved by previous ProtoTRAK and TRAK CNC's. Before conversion, you can easily rename the file in the ProtoTRAK SM CNC current memory.

#### 14.10.1 File Formats

The ProtoTRAK SM CNC can store and retrieve the following ProtoTRAK and TRAK CNC "dot" file formats.

Previous ProtoTRAK and TRAK CNC "dot" file formats:

ProtoTRAK M2	.mx2 (pronounced "dot" mx2)
ProtoTRAK MX2	.mx2
ProtoTRAK MX2E	.mx2
TRAK AGE2	.mx2
ProtoTRAK EDGE	.mx2
ProtoTRAK M3	.mx3
ProtoTRAK MX3	.mx3
ProtoTRAK MX3E	.mx3
TRAK AGE3	.mx3
TRAK QMV	.mx3

#### 14.10.2 Opening .MX2 and .MX3 files on a ProtoTRAK SM CNC

Programs written on previous generation ProtoTRAK and TRAK CNCs may be opened and run on the ProtoTRAK SM CNC. You will need to have the .MX2 or MX3 converters activated (see section 14.9 above). The ProtoTRAK SM CNC will automatically convert the file (.MX2 or .MX3) to a .PT4 file. The original file will remain on the storage device unchanged and the converted file will be in current memory. You will have to save the converted file using the procedure in Section 14.4 above in order to place in into storage.

Since there are some feature differences between the ProtoTRAK SM and previous generation controls, you will have to pay attention to the following:

Event or feature	Comment	Result
Nested Repeats	These are handled a bit differently between the controls. The Nested Repeat must reference all event numbers from a previous Repeat event, not just the previous Repeat event number, otherwise it will be ignored.	For example Not Acceptable: Event #13 Repeat Events #1-12; Event #14 Repeat Events #13. Acceptable: Event #13 Repeat Events #1-12; Event #14 Repeat Events #1-13.
3 or 4 Sided Pocket	These Events will be recognized by the ProtoTRAK SM CNC but in a modified format.	The ProtoTRAK SM CNC will convert the 3 or 4 Sided Pocket routines into an Irregular Pocket Event.



### 14.10.3 Running ProtoTRAK SM Files on ProtoTRAK and TRAK CNC Controls

In order to have a program written on a ProtoTRAK SM run on a previous version ProtoTRAK or TRAK CNC, you will need the .MX2 and .MX3 converters activated (see section 14.9 above). Save the program as either a .MX2 or .MX3 file (depending on the control or program you want to run).

Since there are some feature differences between the CNC's the process will generally yield a useable .mx2 or .mx3 program but with the following exceptions:

Event or feature	Comment	Result
Hidden Areas in Irregular Pocket	The ProtoTRAK or TRAK CNC does not recognize Hidden Areas in Irregular Pockets.	The Irregular Pocket will be converted to an Irregular Pocket; however, the ProtoTRAK or TRAK CNC will display an error message that there are Hidden Areas in the Irregular Pocket. We recommend that you separate the Irregular Pocket into two or more Irregular Pockets using the ProtoTRAK SM before conversion.
Tap Events	This routine does not exist in the ProtoTRAK or TRAK CNC.	The routine will be ignored in the converted program. We recommend that you reprogram the Tap Events into Drill or Position events before conversion.
Copy Repeat Subroutines with %Feed or %RPM	The %Feed or %RPM function does not exist on the ProtoTRAK or TRAK CNC	The %Feed or %RPM information will be removed from the Copy Repeat Subroutines. The programmed feed rates will be run. We recommend that you inspect the feed rates before running the program on the ProtoTRAK or TRAK CNC when the %s are other than 100%.
Tool Path Programming	Only Part Geometry programming is supported on the ProtoTRAK or TRAK CNC.	You can only transfer Part Geometry programs to the ProtoTRAK or TRAK CNC.
Zig-Zag Entry Mode Ramps	This routine does not exist in the ProtoTRAK or TRAK CNC.	The routine will be converted to a Plunge routine. We recommend that you check your Z feedrate to make sure it will be correct for a plunge.
Event Comments	Event comments are not supported on the ProtoTRAK or TRAK CNC.	Event comments will be ignored.
Thread Mill	This routine does not exist in the ProtoTRAK or TRAK CNC.	Thread Mill events will be ignored. We recommend that you replace these events with the Helix Events and Mill Events to ramp in and ramp out of the helix.
Tool Table Info	The part programs for ProtoTRAK or TRAK CNC do not contain tool table information. This information is kept separately.	Tool table information will have to be set in the ProtoTRAK or TRAK CNC as usual.
Irregular Profile	The ProtoTRAK or TRAK CNC does not contain an Irregular Profile Event.	The Irregular Profile Event will be converted to Mill and Arc Events and the programming of the finish cut and steps will be lost. We recommend that after conversion, you add repeat events for the steps and finish cut, using the technique of overstating the size of the cutter you will use to cut the profile.

## 14.11 Running G Code Files

The ProtoTRAK SM allows you to run G Code files directly without having them converted to the ProtoTRAK SM programming format. You may want to do this if you have a very large CAM file made up of small XYZ position moves, or if there is complex surface contouring. In these cases, the ProtoTRAK SM can handle the files more efficiently by running the G Code directly. While running the G Code file directly does not give you the benefit of the easy programming format of the ProtoTRAK SM, you are not likely to be able to use this benefit with a very large or complex file anyway.

To run the G Code file directly, open the file using OPEN AS: G Code .GCD. The entire program will be brought into current memory. You will be able to view the tool path when you run the program in the Run Mode, but you will not be able to edit the program or view it in the Program Mode. In order to edit the program, you will have to use the same application (usually CAM) that you used to write the program originally.

### 14.11.1 G Codes Recognized by the ProtoTRAK SM CNC

G00	positioning (rapid)
G01	linear interpolation (feed)
G02	circular interpolation CW
G03	circular interpolation CCW
G06	CW Helix
G07	CCW Helix
G16	Selects a vertical plane via a bearing angle (value in 'D' word) from the x axis
G17	Selects the XY plane for circular interpolation.
G18	Selects the XZ plane for circular interpolation.
G19	Selects the YZ plane for circular interpolation.
G20	input in inch
G21	input in mm
G40	cutter compensation cancel (for SWI it means center)
G41	cutter compensation left
G42	cutter compensation right
G61	exact stop check mode
G64	cutting mode (no hesitation between events. NOHES=true)
G80	Hole machining canned cycle
G81	Drill canned cycle
G82	Spot drilling canned cycle
G83	Peck drilling canned cycle
G84	Tapping canned cycle
G85	Boring canned cycle

### 14.11.2 M Codes Supported by the ProtoTRAK SM CNC

M00	program stop with prompt (press go to procd.)
M01	optional stop
M02	end of program (no rewind)
M03	spindle CW
M04	spindle CCW
M05	spindle stop
M06	tool change
M07	mist coolant ON
M08	flood coolant ON
M09	coolant OFF
M30	end program (rewind stop)
M79	Send SWI 'O' (ascii 79) commands, value in 'P' word
M98	Subroutine Call to block (PWORD), repeat (L WORD)

14.11.3	Valid Characters for Word/Address Sequences	
G	Prepare to execute a G COMMAND	ParseGcode
M	Prepare to execute a M COMMAND	ParseMcode
N	Introduces a block number	ParseEventNum
T	Specifies the tool number to use	ParseToolNum
F	Specifies a feedrate	ParseFcode
S	Specifies a spindle rpm	ParseScode
D	Specifies the diameter for the current tool	ParseDval,
E	Optional parameter	ParseEval,
X	Specifies the X dimension	ParseXval,
Y	Specifies the Y dimension	ParseYval,
Z	Specifies the Z dimension	ParseZval,
I	Specifies the incremental X dimension	ParseIval
J	Specifies the incremental Y dimension	ParseJval
K	Specifies the incremental Z dimension	ParseKval
L	An Optional Parameter	ParseLval
P	An Optional Parameter	ParsePval
(	Introduces a comment	ParseComment

## 14.12 Networking

This portion of the ProtoTRAK SM CNC manual is written to give you a brief overview of networking and point out the benefits that can be received when setting up the ProtoTRAK SM CNC control in a network environment. There are many resources available at most bookstores on this subject.

### 14.12.1 What is a Network?

A *network* is nothing more than two or more computers connected by a cable so that they can exchange information.

Networks are often called LANs (Local Area Network)

### 14.12.2 Why would you want to use the networking capability of the ProtoTRAK SM CNC control?

1. To allow an easy way to backup programs to other computers or a dedicated storage device(s) connected to the network.
2. To transfer files between the ProtoTRAK SM CNC control and other SM, ProtoTRAK or Fanuc-type controls
3. To import CAD/CAM programs written on other computers connected to the network
4. To access printers on the network
5. To access e-mail over the network
6. To access an internet modem that is connected to the network
7. To run programs that are larger than the ProtoTRAK SM CNC control's storage capabilities from network storage devices connected to the network
8. To allow easy access for customer service support (i.e.; software updates and access to error logs via the internet)

The two most common types of networking are *peer-to-peer networking* and networking using a *server and clients*. Both types of networking can be used in a multitude of configurations, so for the purpose of this manual, we will focus on their most basic forms.

### 14.12.3 A Word of Advice Before Setting up Your Network

Setting up a network can be very tricky. Getting all the necessary components to install correctly and to communicate with your software properly can literally require hours of troubleshooting, even by experts. If you are very knowledgeable about networking and/or have set up a network before, then we encourage you to proceed through the following set of instructions. If you have little or no experience with computers or networking, then we strongly urge you to find a computer consultant to help you set up the network with your new ProtoTRAK SM CNC control. You can find these people in the Yellow Pages.

### 14.12.4 Peer-to-Peer Networking

The most basic type of networking is called *peer-to-peer networking*. This involves simply connecting two or more computers together with a cable attached to a *network interface card*, which is installed into each computer.

**Network Interface Card (also known as an Ethernet Card):** an electronic circuit adapter card that is placed inside a computer and allows it to attach to a special network cable.

**Network Cable:** The network cable is what physically plugs into a network interface card to allow the computers to communicate with one another.

There are many types of network cables. The network interface card inside the ProtoTRAK SM CNC control requires a *twisted-pair category 5 rated network cable*, which looks like a telephone cable and is readily available at most computer supply stores.

In a peer-to-peer network, all the computers that are connected together are thought of as peers, or equals. The ProtoTRAK SM CNC control can be considered a peer to other CNC's or desktop computers.

Peer-to-peer networking features are built right into the Windows 95/98/ME/XP software. If you are using any of these Microsoft operating systems you do not have to purchase any additional software to set up this type of network. The ProtoTRAK SM CNC control uses the Windows 95 OSR2 operating system.

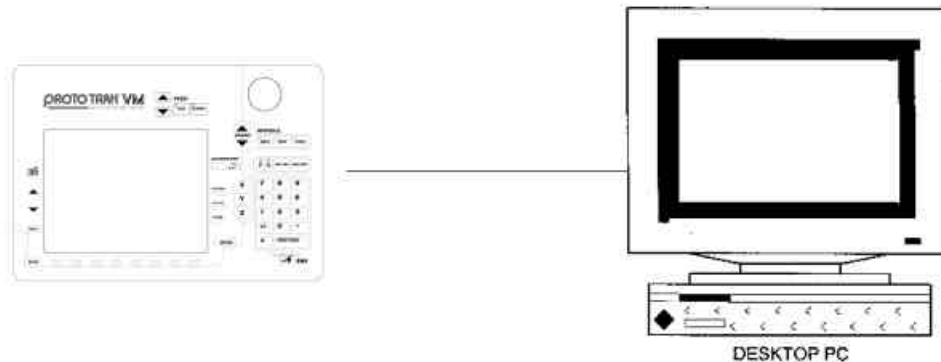

**FIGURE 14.12.4** Peer-to-Peer (desktop PC to ProtoTRAK)

### 14.12.5 Basic Network Set-Up

This section will give you instructions for the most basic set-up of one ProtoTRAK with one desktop computer. The desktop computer must have an Ethernet card installed. Use a crossover CAT5 cable to connect the machines. Before you begin, connect a keyboard and mouse to your ProtoTRAK and turn the ProtoTRAK on with them connected so that it will recognize them. If your set-up is more complicated than that pictured in Figure 14.12.4, you should skip this section and see Section 14.12.6.

1. For the ProtoTRAK VL and VM CNCs, press the Windows key and then press Windows 98. For the ProtoTRAK SM and SL, press the SYS key, then press CONFIG NETWORK. This will take you to the Windows desktop.
2. From there, click on START, then go to SETTINGS, CONTROL PANEL.
3. Double click the "NETWORK" icon, and go to the Configuration tab. You should get a window that looks something like the one below.



**Figure 14.12.5.1**

There are 4 components that are needed:

- Client for Microsoft Networks
  - Realtek PCI Fast Ethernet Adapter
  - TCP/IP
  - File and Printer sharing.
4. Double click on Realtek PCI Fast Ethernet, it should be the one with the green icon next to it.
  5. Under the Bindings tab, make sure that you have the option checked off which should read TCP/IP as shown in Figure 14.12.5.2.

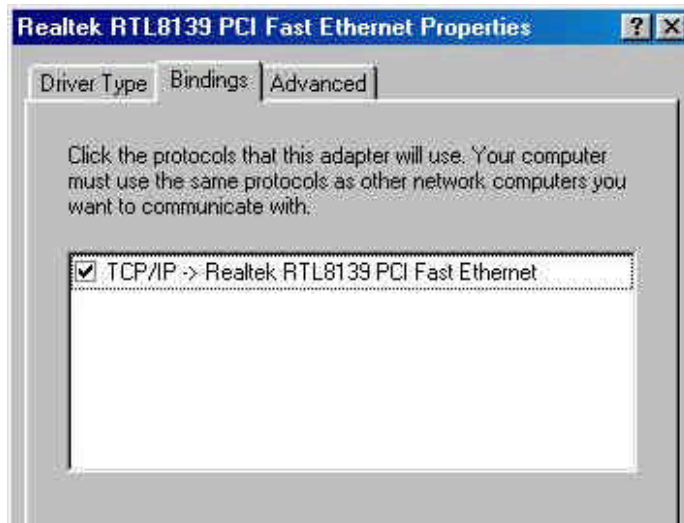

**Figure 14.12.5.2**

6. Exit this window and go back to the first Network window.
7. Highlight the line which reads "TCP/IP—Realtek PCI Fast Ethernet"
8. Click on "Properties", under the "IP address" tab, select "Specify an IP address". Now type in an IP address, making sure to match the first set of numbers with the IP address of the computer that you are connecting to. (You can obtain your computer's current IP number by going to START -> RUN -> WINIPCFG. Otherwise you can manually enter one).

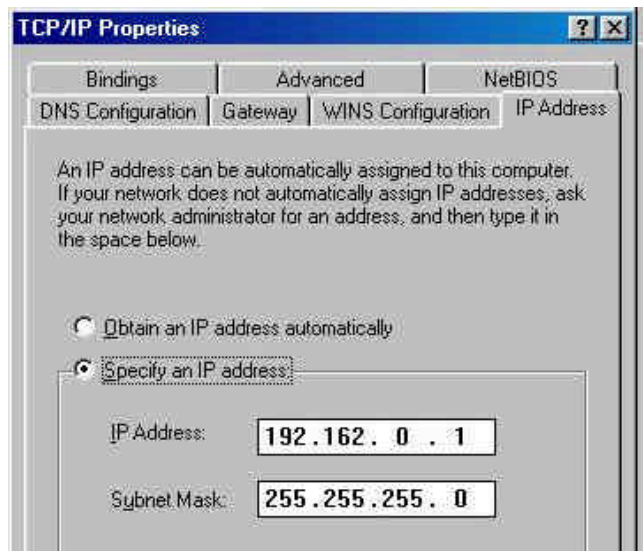

**Figure 14.12.5.3**

9. Click on the "DNS Configuration" tab, and make sure that it is disabled.
10. Click on the "WINS Configuration" tab, and make sure that is disabled as well.
11. Click on the "Bindings" tab, and make sure that you have "Client for Microsoft Network" and "File and printer sharing" checked. You will need these in order to log on correctly as well as be able to transfer files from one computer to the other.

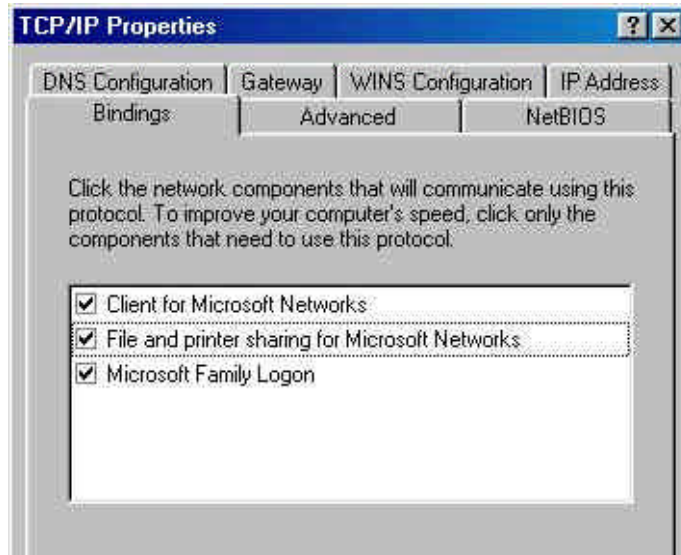

**Figure 14.12.5.4** TCP bindings

12. Close this window and return to the original Network window. Click on the "Identification" tab.
13. Compare these settings to the ones on your computer, and make sure that workgroup is the same for both, and that they each have unique computer names. (See Figure 14.12.5.5)

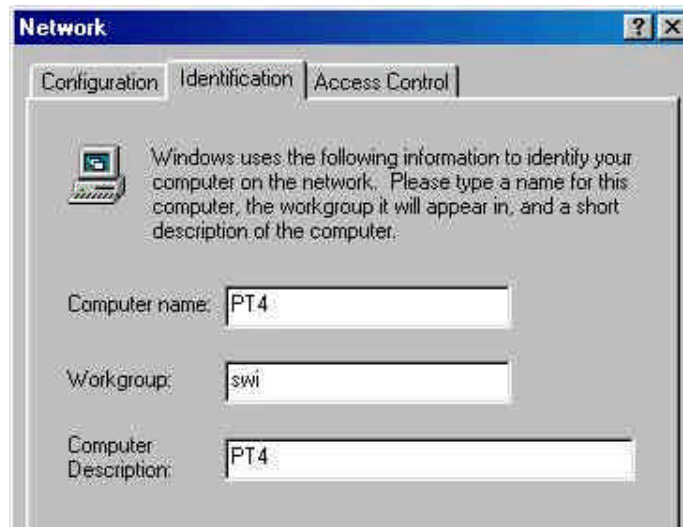
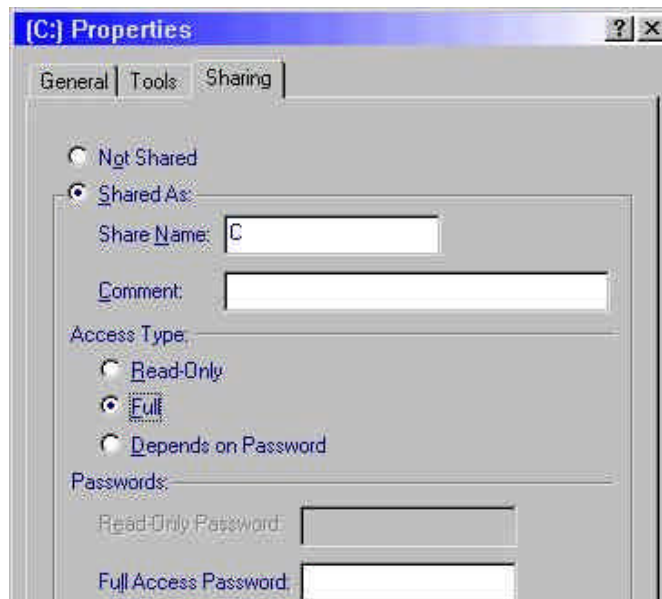

**Figure 14.12.5.5** Identification

14. Finally, close the windows. Restart the ProtoTRAK.
15. On your computer, you want to make sure (using the same steps), that you have TCP/IP installed, matching workgroups, unique computer names, unique IP addresses that will work together (192.162.0.1 & 192.162.0.2 for example), Client for Microsoft Windows, and file and printer sharing enabled.
16. Restart both the computer and your ProtoTRAK. To verify that we have successfully networked both computers together, on your desktop double click on Network Neighborhood. You should see each other's computer name here. If not, contact SWI customer service or your systems administrator for technical support.

Now you will need to share and map at least one drive in order to be able to transfer files back and forth between two networked computers. Sharing a drive determines what folders on your computer you want to share with the rest of the network. Mapping sets up a drive on your computer as a shortcut to a shared folder across a network. Depending on your needs, you would most likely want to share a folder on your PC, and map it on your ProtoTRAK.

17. To share a drive / folder on your computer, first you must locate it using Windows Explorer. Double click on MY COMPUTER, then on C DRIVE. Find the folder you wish to share, then using the right mouse button click on it and select SHARING. You can also share the entire C drive if you'd like (making everything on your hard drive available for sharing). You should get a window like the one below.



**Figure 14.12.5.6** *Sharing*

18. Make sure you select the option "Shared As", and most likely you will want to select Full access type, so that you can open AND save files across the network. Click on OK when you are finished.
19. To map a drive on your ProtoTRAK, go into Windows 98, and then double click on NETWORK NEIGHBORHOOD on your desktop. You should be able to see the name of the computer(s) that you are currently networked to. Double click on the one you wish to map to, and when opened you should see a list of all folders that we enabled sharing. Right click on one of these folders, and select "Map Network Drive", you should get a window like the one below.



**Figure 14.12.5.7** *Mapping*



20. Choose an available drive letter of your choice, make sure that the “Reconnect at logon” option is checked, and click OK. From now on, the drive letter that you chose will be assigned as a shortcut to the shared folder (which is actually a folder stored on the networked computer). On your ProtoTRAK, you will be able to see this drive when you go to PROG IN/OUT, and attempt to OPEN or SAVE your files. Using the TAB button to move to the LOOK IN window, you should now be able to save / retrieve to and from your newly mapped network drive.

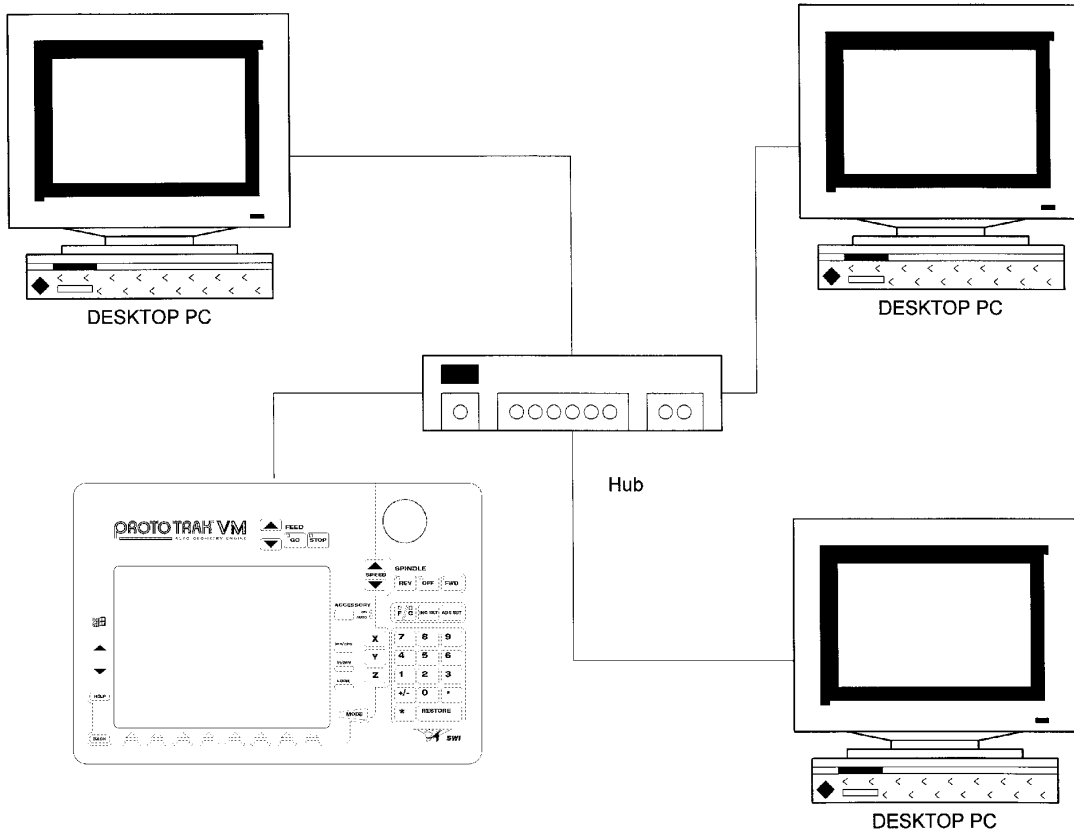

**FIGURE 14.12.6** Peer-to-Peer (3 desktop PC's and 1 SM CNC control hooked to a hub

### 14.12.6 Server and Client Network Overview

A more complex type of network, often found within an office environment, involves the use of a *server* and individual *clients*. Connecting more than two computers requires the addition of a hub.

**Server:** a computer that is dedicated primarily to the task of providing shared resources, such as hard drives, and printers to other users on a network.

**Client:** a computer that has access to a network server and shares its resources.

**Hub:** a device that allows multiple computers to communicate with each other.

We recommend that you use a DHCP switch instead of a simple hub. The switch will automatically assign IP addresses, subnet masks, and gateway addresses in addition to performing the distribution functions of a hub.

This will make setting up multiple CNCs or computers easier. Simply use the default settings shown in Section 14.12.6 and plug the devices into the switch.

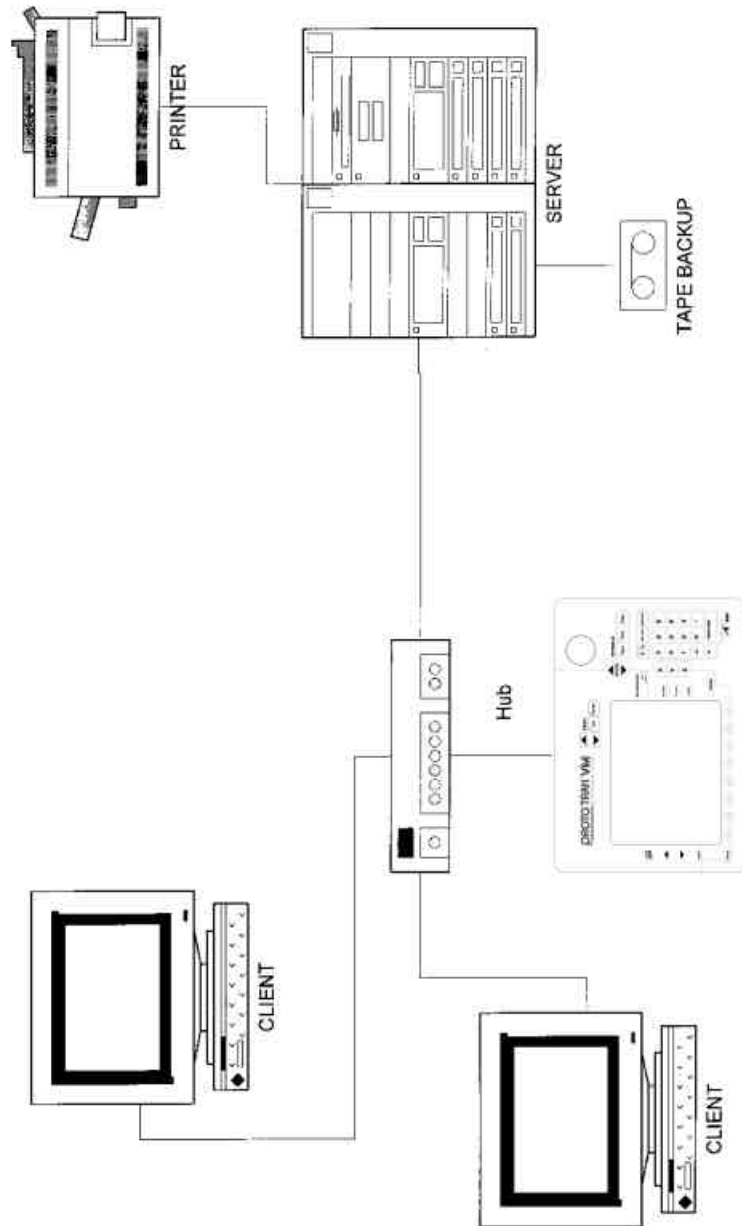

100847

**FIGURE 14.12.7** Typical server and client set-up diagram

In many companies, a main database is often kept on the server and is accessed by the clients. The client can be thought of as an individual desktop computer in an office cubicle. When the person using a client needs to make a change to a main database, he accesses the server through the network.

The server uses software specifically designed to manage this type of network set-up. The most commonly used software is Microsoft Windows NT/2000. This software carries out the tasks of coordinating the access to shared network resources among the network client computers. Most clients use a desktop version of Microsoft Windows 95/98/ME/XP.

#### 14.12.7 Network Description of the ProtoTRAK

The following table summarizes important settings for the ProtoTRAK V series and ProtoTRAK S series CNCs. It is intended for use by a professional Network Administrator.

*Note: The ProtoTRAK has many similarities to a desktop computer, but it is somewhat different because the use of the computer's resources is optimized for running part programs and a machine in real time. In order to avoid causing a slow-down or even instability in the operating system of the control, keep the following in mind while setting up the network:*

- Do not use a resource-intensive networking program such as SMS.
- Avoid loading in programs that direct background tasks, e.g. anti-virus programs.

ProtoTRAK system	SL or SM	VL or VM
Windows	95 OSR 2	98 Second edition
Processor	Pentium 2 - 233	Pentium 2 - 233
Memory- RAM	32	32
Disk	Compact flash, optional second compact flash	Hard drive, 2 gig or bigger
Floppy drive	Yes	Yes
Network	10/100 base T Ethernet	10/100 base T Ethernet
Ports available	COM1, LPT 1	COM1, LPT 1
System software	Not available to user. Instead use second flash drive, Network or LPT CDROM	Full Windows distribution on hard drive in C:\WIN98.

System and network set up	
Default password	PT4
Default user name	PT4
Default computer name	PT4SN0001
Default work group	SWI
Network settings	Client for MS Networks
	File and print sharing
Default protocols	Net beui
	TCP/IP
Network log in	Windows log in*
	Enabled share level access control
TCP/IP set up	Obtain IP address automatically
Dns	Disabled
Gateway	Not used
Wins configuration	Use DHCP for wins resolution

\*do not change

## 14.13 RS232 Interface

While networking and floppy disks are more modern, reliable and convenient methods, the RS232 protocol may also be used to transfer files between the ProtoTRAK SM CNC and other controls and computers. The ProtoTRAK SM CNC will support RS232 file transfer for Open and Save operations in the Program In/Out Mode. The other operations (such as Back up) cannot be done through RS232.

### 14.13.1 Connections

To transfer a file between the ProtoTRAK SM CNC and a remote computer or control, the two systems must be connected to each other with an RS232 cable. On the ProtoTRAK SM CNC, plug the cable into the connector on the left side of the pendant (see Figure 3.2). On the remote computer or control, the cable may go to any available serial port. The baud rate for the ProtoTRAK SM CNC is set at 4800; use Service Code 37 to reset the baud rate.

The pin-out for the 9-pin connector is the standard RS232 PC - PC Laplink/Interlink cable (PC 9 way female - PC 9 way female).

9D Female RS232 signal	Pin		Pin	9D Female RS232 signal
GND	Case	-----	Case	Gnd
TxD	3	-----	2	RxD
RxD	2	-----	3	TxD
RTS	7	-----	6	DSR
CTS	8	-----	4	DTR
DSR	6	-----	7	RTS
SG	5	-----	5	SG
DTR	4	-----	8	CTS

### 14.13.2 Receiving a File

Receiving a file via the RS232 is done through the file Open command. See Figure 14.13.1.

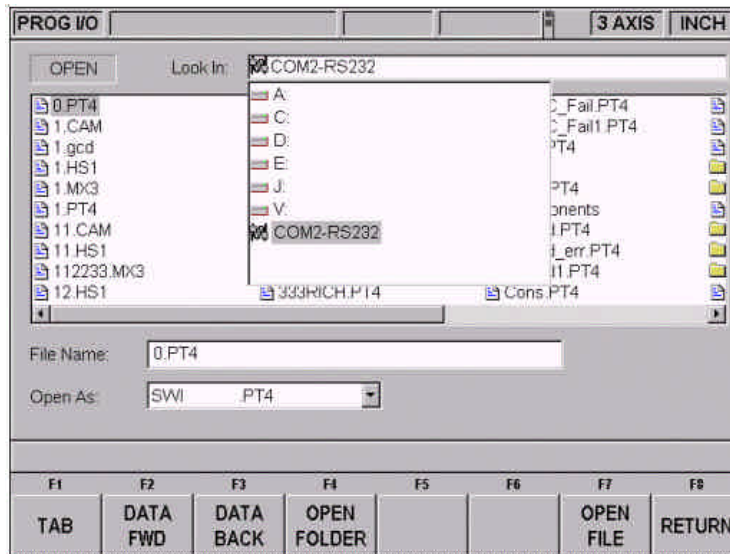

*Figure 14.13.1 The RS232 port is selected in the Look In box.*

Once the RS232 port is selected, pressing the Tab key will position the cursor in the now empty list of contents. A message window will appear prompting you to enter the file name of the file you wish to receive. Press Tab again to move the cursor to the File Name box. You may name the file the same name as the one it has on the remote computer or control, or you may give it a different name. After entering the file name, move the cursor to the Open As box and select the format of the file that you wish to receive as it exists in the remote computer or control. For example, if you were transferring a Haas file from a Haas CNC, you would select the file type: HS1.

After you have set up the ProtoTRAK SM CNC to receive the file, press the Open soft key. A message window will appear to notify you that the ProtoTRAK SM CNC is ready to receive the file.

If the remote computer or control is a TRAK or ProtoTRAK CNC (or is a computer that is running ProtoTRAK or TRAK A.G.E. offline software) you can send the file by simply using the Save softkey (via the RS232) in the Program In/Out Mode. If the remote computer or control is not a TRAK or ProtoTRAK CNC, consult your manual for sending files via the communications port.

Modern Windows operating systems have programs such as Windows hyper-terminal and CAD/CAM systems have the capability of communicating via the RS232 port.

Modern Windows operating systems have programs such as Windows hyper-terminal and CAD/CAM systems have the capability of communicating via the RS232 port.

The commands for an MS-DOS system are:

```
'mode COM1: 4800,e,7,1' – to set up the port where COM1 is the serial port on  
the remote computer  
and 'copy "filename" COM1: ' – to send a copy of the file to the COM1 port.
```

As the program is received it will be converted into the ProtoTRAK SM CNC format and put into the current memory. Once the transfer is complete, the Select a Mode screen will appear.

### 14.13.3 Sending a File

Sending a file via the RS232 is done through the file Save command. Transfer will take place only with a program that is in the ProtoTRAK SM CNC's current memory.

As with receiving the file, the RS232 port must be selected in the Look In box.

Since the file name does not transfer with the program through RS232, you can ignore the file name box.

Place the cursor into the Save As box and select a file format. The ProtoTRAK SM CNC will convert the file to the format that you select as it is being sent to the remote computer or control.

Once the transfer is set up, press the Save soft key. The ProtoTRAK SM CNC will be placed in a ready state for transferring the file to the remote computer or control. A second Save key press is required to go from this ready state to actually sending.

The remote computer or control must be set up to receive the file. If the remote computer or control is a TRAK or ProtoTRAK CNC (or is a computer that is running ProtoTRAK or TRAK A.G.E. offline software) you can receive the file by simply using the Open softkey (via the RS232) in the Program In/Out Mode. If the remote computer or control is not a TRAK or ProtoTRAK CNC, consult your manual for sending files via the communications port.

The MS-DOS commands for receiving the file are:

```
'mode COM1: 4800,e,7,1'  
and then: 'copy "filename" COM1:'
```

The receiving computer or control will attach the filename to the program it receives via the RS232 port.

When the receiving computer or control is ready, press the Save key a second time to send the file.

Once the file is sent, the Program In/Out Mode Save screen will remain and the Look In drive will change to the one used previous to the RS232 operation.

#### **14.14 CAD/CAM and Post Processors.**

In addition to running G-code files, the ProtoTRAK will also accept CAM files and convert them into the ProtoTRAK events. This is a great advantage as it allows you to have your CAD/CAM programmer send files to the machine that the machinist can then work with in the familiar ProtoTRAK interface. The machinist can modify the program as necessary without having to go back to the CAD/CAM programmer.

In order to be able to convert the program from a CAM system to a ProtoTRAK program the CAM program must be two or 2½ axis. A 2½ -axis program is defined as a program where the Z axis is stationary while X and Y is moving. If you want to run a full three-axis program, you should run a G Code, or .GCD program (see section 13.11).

The above 2½ -axis restriction does not mean that the ProtoTRAK is not capable of running three-axis simultaneous programs written in ProtoTRAK events (as some ill-informed competitors would have you believe). This restriction is a matter of practicality. Because the ProtoTRAK allows you to program in part geometry and therefore will figure out the tool path for you, the process of converting a three-axis program gives the ProtoTRAK a tool position problem that it cannot resolve without a lot more data from you. The other reason is that the output from a CAM systems for three-axis shapes is in the form of thousands and thousands of straight-line G01 moves that would convert into the equal number of ProtoTRAK Mill events. This is hardly a manageable program.

Instead of forcing the issue in a silly way, we give you the more elegant solution of running GCD files. To our competitors, we respectfully point out that the thread and helix milling canned cycles of the ProtoTRAK are three-axis simultaneous interpolation.

In order to run a CAM program, the program must be posted through a post-processor that makes some adjustments to the output of the CAM software so that it is understood by the ProtoTRAK. The ProtoTRAK uses a post-processor that is very similar to the Fanuc 6M.

If you are not familiar with writing a post-processor, we recommend that you contact your CAD/CAM supplier. We will be happy to work with him to get you the post-processor you need.

#### 14.14.1 Writing a Post Processor

The following are modifications to a Fanuc 6 post-processor that are necessary for writing the ProtoTRAK post-processor.

**Beginning file format:** The ProtoTRAK has no special requirements, it does not need any special characters.

**End of file format:** the ProtoTRAK requires the % to show the end of the file. Characters after the % will be ignored.

**Beginning of an operation:** the ProtoTRAK requires that the tool number, feedrate and tool offset appear before, or on the same line, as a move command. In addition, the ProtoTRAK VM (but not the SM) requires the spindle speed be set. The absolute zero of the ProtoTRAK is set in a different mode and does not need to be set at the beginning of each operation. The feedrate is modal; once it is set it remains the same until changed.

**Lines:** the line feed (or carriage return/line feed) signals the end of the line (ASCII code hex 0A or OD 0A). A semicolon is optional.

**Coordinates:** may be formatted in inch or metric. The addresses used for specifying coordinates are X, Y, Z, I, J, K. The valid ranges are:

- Inch: min -99.9999 to max +99.9999
- Mm: min -999.99 to max +99.999

**Rapid moves:** rapid moves are generated by the ProtoTRAK automatically as part of the definition of an event. For this reason, G0 moves are discarded unless they specify a location other than the beginning of the following event.

**Linear moves:** G01 are formatted the same as rapid moves.

**Arcs:** Arc centers are specified by the address I, J and K for the X, Y and Z axes. The number following the I, J and K are incrementally referenced from the starting point of the arc. Radius values are not allowed.

**Tool Numbers and Tool Changes:** the format of the tool number is from T1 to T99. During program run, the ProtoTRAK will rapid to home for a tool change and pause for the tool to be loaded manually and the operator to press GO.

**Feed rates:** the ProtoTRAK is programmed in inches (or mm) per minute using the 'F' address.

**Spindle speed:** the ProtoTRAK SM does not have spindle speed control, so S values are ignored. The VM uses S values.

**File name:** use the .CAM extension so the ProtoTRAK will recognize the file as a CAM file and convert it into ProtoTRAK events when it is opened. File names may include up to 20 alpha-numeric characters.

### 14.14.2 Convertible G-Codes

The following G-codes may be used in a CAM file that you want to have converted to a ProtoTRAK program. G Codes that are not on the list below have no correspondent operation in the ProtoTRAK events and will be ignored when the program is converted.

If a G Code is essential to your program and you do not see it here, you can do one of two things.

- Convert the file from CAM to ProtoTRAK and add an event to the resulting ProtoTRAK program.
- Run the program as a GCD file (See Section 13.11).

<b>G Code</b>	<b>Description</b>
G00	Rapid positioning
G01	Linear interpolation
G02	Circular interpolation CW
G03	Circular interpolation CCW
G20	Input in inch
G21	Input in metric
G40	Cutter compensation cancel
G41	Cutter compensation left
G42	Cutter compensation right
G54	Work coordinate system 1 selection
G55	Work coordinate system 2 selection
G56	Work coordinate system 3 selection
G57	Work coordinate system 4 selection
G58	Work coordinate system 5 selection
G59	Work coordinate system 6 selection
G73	Peck drilling cycle
G80	Hole machining canned cycle cancel
G81	Drilling cycle, spot boring
G82	Drilling cycle, counter boring
G83	Face hole machining cycle
G84	Tapping canned cycle (VM only)
G85	Face boring cycle
G89	Boring cycle, dwell at bottom
G90	Absolute programming
G91	Incremental programming
G98	Return to initial point in canned cycle
G99	Return to point R in canned cycle

### 14.14.3 Supported Addresses

CAM information is communicated through the use of ADDRESS – WORD pairs. For example in the line "N01G0X1.Y2." N, G, X, and Y are addresses. The other information (01, 1, and 2) are Data Words. The line starts with the Address = N and the data word = 01. The N address is defined as meaning "LINE NUMBER", therefore N01 means Line # 1, and so on.



X, Y, Z	Dimensions along the specified axis
I, J, K	Distance to arc center I = X, J = Y, K = Z.
D	Tool Diameter
M	Miscellaneous Functions
G	Preparatory Function
H	Tool Length Offset Selector (silently ignored).
N	Line Number (silently ignored)
T	Tool Number
F	Feedrate
P	Dwell time for drill/bore canned cycles
L	Repetition count for drill/bore canned cycles
Q	Depth of cut for drill/bore canned cycles
R	Reference point for drill/bore canned cycles
S	Spindle Speed

#### 14.14.4 Format Terms and Definitions

##### Number formats

- A. preparatory function number, denoted <prep-func>
  - 1. format: dd
  - 2. leading 0 suppression
  - 3. range: 0 to 99
  
- B. sequence or line number, denoted <seq-number>
  - 1. format (independent of units): dddd
  - 2. leading 0 suppression
  - 3. range: 1 to 9999
  
- C. Unsigned coordinate word, denoted <coord>
  - 1. format:  
metric: ddddd.ddd  
inch: dddd.dddd
  - 2. the "+" sign is implied and therefore may be omitted
  - 3. leading 0 suppression
  - 4. if no decimal point is given, the supplied number will be interpreted as an integer (i.e. a whole number).
  - 5. Fractional portion is optional
  - 6. Range:  
metric: 0 to 99999.999  
inch: 0 to 9999.9999
  
- D. signed coordinate word, denoted <scoord>
  - 1. format:  
negative number: -<coord>  
positive number: +<coord> or <coord>
  - 2. range:  
metric: -99999.999 to 99999.999  
inch: -9999.9999 to 9999.9999
  
- E. tool function, denoted <tool>
  - 1. format : dd (use 2-digit only)
  - 2. leading 0 suppression
  - 3. range: 1 to 99.

- F. miscellaneous or M codes function number, denoted <prep-func>
  1. format: dd
  2. leading 0 suppression
  3. range: 1 to 99
  
- G. feedrate values, denoted <frate>
  1. format:
    - metric: ddddd
    - inch: ddd.dd
  2. leading 0 suppression
  3. decimal point not required
  4. fractional portion is optional
  5. range:
    - metric: 1 to 6350
    - inch: 0.1 to 250
  
- H. RPM command (VM)
  1. format: dddd
    - S1000 = 1000 RPM

#### 14.14.5 G Codes that Generate Errors

<b>G Code</b>	<b>Function</b>
G27	Reference point return check
G28	Return to reference point
G29	Return from reference point
G30	Return to 2 <sup>nd</sup> reference point
G31	Skip function
G33	Thread cutting
G37	Tool length automatic measurement
G38	Cutter radius compensation vector change
G39	Cutter radius compensation corner rounding
G45	Tool offset increase
G46	Tool offset decrease
G47	Tool offset double increase
G48	Tool offset double decrease
G62	Automatic corner override mode
G63	Tapping mode
G65	User macro simple call
G66	User macro modal call
G67	User macro modal call cancel
G74	Counter tapping cycle
G76	Fine boring
G86	Boring cycle
G87	Back boring cycle
G88	Boring cycle
G92	Programming of absolute zero point
G95	Feed per revolution

#### 14.14.6 Accepted M Codes

<b>M Code</b>	<b>Function</b>
M00	A pause is generated. The axes will not move, but the motors will be engaged. The spindle motor will not turn off.
M02	Executed automatically at the end of all programs. Turns off the servo motors and all auxiliary functions. The auxiliary function box must be present for this function to work.
M05	Stops the spindle at the end of the current event. The auxiliary function box must be present for this function to work.
M06	Tool change. The M06 is ignored, as the tool change on the ProtoTRAK is accomplished by changing the tool number.
M07	Flood coolant on. This will turn on the auxiliary box A/C outlet before the event.
M08	Mist coolant on. This will turn on the air supply from the auxiliary box before the event.
M09	Coolant off. This will turn off the auxiliary box A/C outlet and air supply after the event.
M12 & M20	Send a pause to the indexer and wait for an "in position" response.
All other M codes will be ignored.	
<i>Notes:</i>	
<ol style="list-style-type: none"> <li>1. <i>Place M Codes on same line as movement G Code.</i></li> <li>2. <i>One M Code per block.</i></li> </ol>	

# 15.0 Sample Programs

## 15.1 Sample Program No. 1

2-Axis Profile with Limited Print Data

This program is designed to provide practice with the ProtoTRAK SM A.G.E. programming system. A basic rule of thumb for A.G.E. programming:

- When you have unknown tangent elements, you may skip data.
- When you have unknown non-tangent elements, you use the Guess feature.

The Program

All programs start by first selecting "Program" from the front panel softkeys. You may enter in an alphanumeric program description, or simply press "Go to Begin" to get started.

**Be certain to start your program by selecting Profile.**

Sample Drawing 2

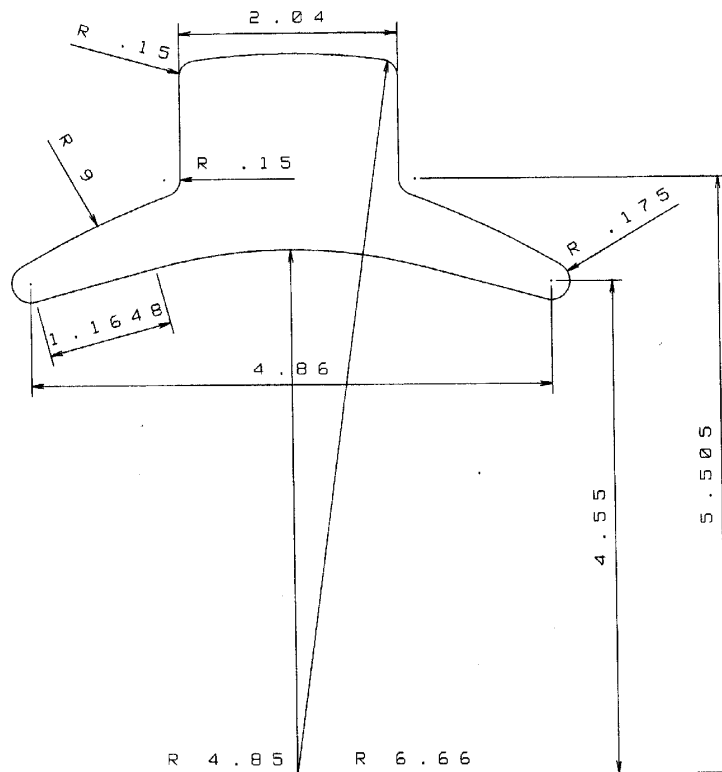

i00851

EVENT 1	IRREGULAR PROFILE	NOTES
X Begin Y Begin Tool Offset Finish Cut Feedrate Fin Feedrate Tool #	-1. abs 6.66 abs 2 Inc Set 100 abs Inc Set abs/set	Leads into part – no witness mark Leads into part – no witness mark Sets tool offset LEFT Means no finish cut Sets feedrate to 100 ipm. Means no finish feedrate Sets tool to default # 1

EVENT 2	AGE Mill	NOTES
Tangent X End Y End Conrad Angle End Length Line Angle	1 0 6.66 abs	Selects Tan Mill Known print value Known print value <b>Press Page Forward now, as no further data is required</b>

EVENT 3	AGE ARC	NOTES
Tangent Direction X End Y End X Center Y Center Conrad Radius Chord Length Chord Angle	1 1 abs 1.02 abs Guess (6.6) abs Abs/set Abs/set .15	Selects Tan Arc Selects CW arc direction Known endpoint Unknown endpoint, guess Defaults to 0 – known print dimension Defaults to 0 – known print dimension Sets Conrad of 0.15" <b>Press Page Forward now, as no further data is required</b>

EVENT 4	AGE MILL	NOTES
Tangent X End Y End Conrad Angle End Length Line Angle	1 Inc set 5.505 abs	Selects tan mill By default, X will remain the same Known print dimension <b>Press Page Forward now, as no further data is required</b>

EVENT5	AGE ARC	NOTES
Tangent Direction X End Y End X Center Y Center Conrad Radius Chord Length Chord Angle	1 2 data forward data forward 1.17 abs 5.505 abs data forward 0.15 abs	Selects tan arc CCW arc direction Unknown Endpoint Unknown Endpoint Known Center Known Center  Known print dimension <b>Press Page Forward now</b>

EVENT 6	AGE ARC	NOTES
Tangent Direction X End Y End X Center Y Center Conrad Radius Chord Length Chord Angle	1 1 Data Forward Data Forward Data Forward Data Forward Data Forward 9 abs	Selects tan arc CW arc Unknown data Unknown Data Unknown Data Unknown data Known print dimension <b>Press Page Forward now, as no further data is required</b>

EVENT 7	AGE ARC	NOTES
Tangent Direction X End Y End X Center Y Center Conrad Radius Chord Length Chord Angle	1 1 data forward data forward 2.43 abs 4.55 abs data forward .175 abs	Selects tan arc CW Unknown value – not required Unknown value – not required Known print dimension Known print dimension Known print dimension <b>Press Page Forward now, as no further data is required</b>

EVENT 8	AGE MILL	NOTES
Tangent X End Y End Conrad Angle End Length Line Angle	1	Selects tan mill <b>Press Page Forward now, as no further data is required</b>

Event 9	AGE ARC	NOTES
Tangent Direction X End Y End X Center Y Center Conrad Radius Chord Length Chord Angle	1 2 data forward data forward 0 abs 0 abs data forward 4.85 abs	Selects tan arc CCW Unknown value – not required Unknown value – not required Known print dimension Known print dimension Known print dimension <b>Press Page Forward now, as no further data is required</b>

EVENT 10	AGE MILL	NOTES
Tangent X End Y End Conrad Angle End Length Line Angle	1	Selects tan mill <b>Press Page Forward now, as no further data is required</b>

EVENT 11	AGE ARC	NOTES
Tangent Direction X End Y End X Center Y Center Conrad Radius Chord Length Chord Angle	1 1 data forward data forward -2.43 abs 4.55 abs data forward 0.175 abs	Selects tan arc CW Unknown value – not required Unknown value – not required Known print dimension Known print dimension Known print dimension <b>Press Page Forward now, as no further data is required</b>

EVENT 12	AGE ARC	NOTES
Tangent Direction X End Y End X Center Y Center Conrad Radius Chord Length Chord Angle	1 1 Data Forward Data Forward Data Forward Data Forward Data Forward 9 abs	Selects tan arc CW arc Unknown data Unknown Data Unknown Data Unknown data Radius of Arc <b>Press Page Forward now, as no further data is required</b>

EVENT 13	AGE ARC	NOTES
Tangent Direction X End Y End X Center Y Center Conrad Radius Chord Length Chord Angle	1 2 -1.02 abs 5.505 abs -1.17 abs 5.505 abs	Selects tan arc CCW Known print dimension Known print dimension Known print dimension Known print dimension <b>Press Page Forward now, as no further data is required</b>

EVENT 14	AGE MILL	NOTES
Tangent X End Y End Conrad Angle End Length Line Angle	1 0 inc Guess 6.6 abs 0.15	Selects tan mill X value is unchanged Unknown value – Guess Known print value <b>Press Page Forward now, as no further data is required</b>

EVENT 15	AGE ARC	NOTES
Tangent	1	Selects tan arc
Direction	1	CW
X End	0 abs	Known print dimension
Y End	6.66 abs	Known print dimension
X Center	0 abs	Known print dimension
Y Center	0 abs	Known print dimension
Conrad		<b>Press Page Forward now, as no further data is required</b>
Radius		
Chord Length		
Chord Angle		

EVENT 16	AGE MILL	NOTES
Tangent	1	Selects tan mill (off the part)
X End	1 abs	Known value
Y End	0 inc	Value unchanged
Conrad		<b>Press Page Forward now, as no further data is required</b>
Angle End		
Length		
Line Angle		

**Press the Look Key Now! If all is OK, press Look key again to return to program, and End the AGE.**



## 15.2 Sample Program No. 2

### Basic 2 ½-Axis Program

This program is designed to give you practice on programming 2½ -axis events for 3-axis CNC programming. To practice on 2-axis CNC, simply ignore the Z prompts.

### The Program

All programs start by first selecting "Program" from the front panel softkeys. You may enter in an alphanumeric program description, or simply press "Go to Begin" to get started.

**Start your program by selecting Pocket and then Circle Pocket.**

Sample Drawing 2

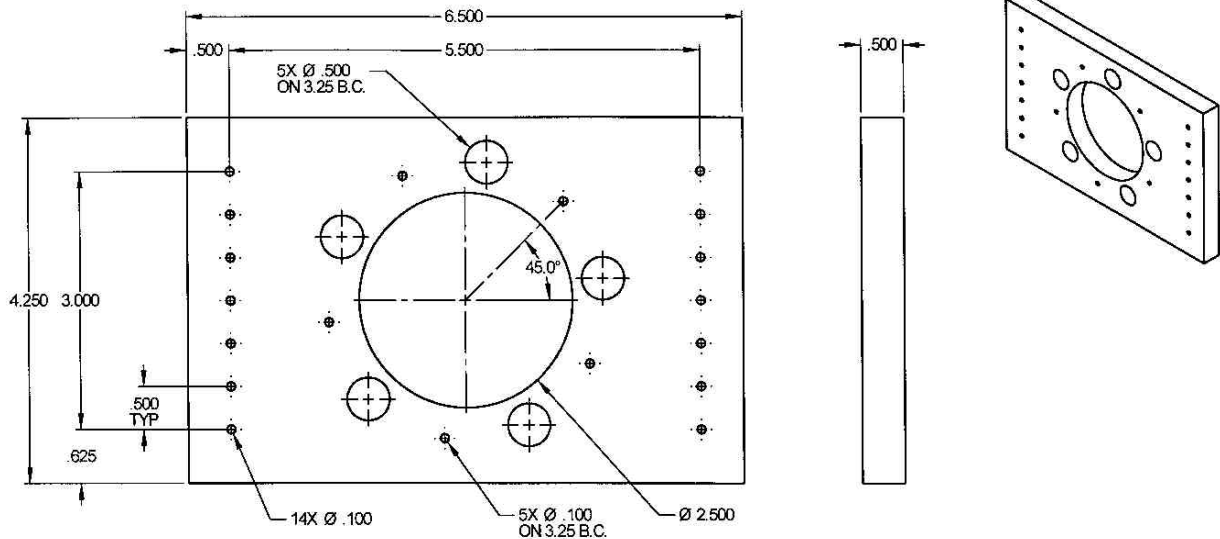

<b>EVENT 1</b>	<b>CIRC PCKT</b>	<b>NOTES</b>
X Center	abs/set	Sets the pocket center to X zero
Y Center	abs/set	Sets the pocket center to Y zero
Z Rapid	.1 abs	Sets the Rapid plane to 0.1"
Z End	-.6 abs	Sets the pocket depth to -0.6"
Radius	1.25 abs	Sets radius of pocket to 1.25"
Direction	2 abs	Makes the cut direction CCW
# of Passes	2 abs	Cuts the pocket using two (2) depths
Entry Mode	1 abs	Makes the tool ramp into the material
Fin Cut	.01 abs	Takes a 0.01" cut to finish the pocket
Z Feedrate	5 abs	Sets the ramp feedrate to 5 ipm
XYZ Feedrate	20 abs	Sets the pocket cutting feedrate to 20 ipm
Fin Feedrate	15 abs	Sets the finish pocket feedrate to 15 ipm.
Tool #	abs/set	Sets tool to default # 1

<b>EVENT 2</b>	<b>Bolt Hole</b>	<b>NOTES – drill for 0.1" bolt pattern</b>
Drill or Bore	1	Selects Drill Function
# of Holes	5 abs	Known print value
X Center	abs	Defaults to X zero
Y Center	abs	Defaults to Y zero
Z Rapid	.1 abs	Sets the rapid plane to 0.1"
Z End	-.6 abs	Sets the drill depth to -0.6"
Radius	1.625 abs	The radius of the bolt hole circle
Angle	45 abs	Angle of first hole from zero (0) degrees
# of Pecks for Drill	6 abs	Sets drill function for 6 pecks
Z Feedrate	10 abs	Sets Z plunge rate to 10 ipm
Tool #	2 abs	Selects Tool # 2 (0.1" drill)

<b>EVENT 3</b>	<b>DRILL</b>	<b>NOTES – center drill for 0.1" hole patterns</b>
Drill or Bore	1 abs	Selects Drill Function
X	2.75 abs	Known print value
Y	-1.5 abs	Known print value
Z Rapid	.1 abs	Sets the rapid plane to 0.1"
Z End	-.6 abs	Sets the drill depth to -0.1"
# of Pecks for Drill	6 abs	Sets drill function for 6 pecks
Z Feedrate	5 abs	Sets Z plunge rate to 5 ipm
Tool #	inc/set	Keeps Tool # 2 (0.1" drill)

**Select More then Copy, then Repeat (to do the drilling using the previous event info)**

<b>EVENT 4</b>	<b>COPY REPEAT</b>	<b>NOTES – for the drill 0.1" operation</b>
First Event #	3 abs	Selects the first event to copy from
Last Event #	3 abs	Selects the last event to copy to
X Offset	inc/set	Does not offset the pattern in X
Y Offset	.5 inc/set	Offset the pattern in Y by 0.5"
Z Rapid Offset	inc/set	Does not change the Z Rapid plane
Z Offset	inc/set	Does not change the Z depth
# Repeats	6 abs	Copies the selected events 6 times
% Feed	inc/set	Leaves the feedrate where it was
Tool #	inc/set	Leaves the previous tool as the current tool

Select More then Copy, then Repeat (to do the drilling using Event # 3 thru 9 info)

<b>EVENT 10</b>	<b>COPY REPEAT</b>	<b>NOTES – for the drill 0.1" operation</b>
First Event #	3 abs	Selects the first event to copy from
Last Event #	9 abs	Selects the last event to copy to
X Offset	-5.5 inc/set	Offset the pattern in X by -5.5"
Y Offset	inc/set	Does not offset the pattern in Y
Z Rapid Offset	inc/set	Does not change the Z Rapid plane
Z Offset	inc/set	Does not change the Z depth
# Repeats	1 inc/set	Copies the selected events 1 time
% Feed	inc/set	Leaves the feedrate where it was
Tool #	inc/set	Leaves the previous tool as the current tool

<b>EVENT 17</b>	<b>BOLT HOTE</b>	<b>NOTES – drill for 0.5" bolt pattern</b>
Drill or Bore	1	Selects Drill Function
# of Holes	5 abs	Known print value
X Center	abs	Defaults to X zero
Y Center	abs	Defaults to Y zero
Z Rapid	.1 abs	Sets the rapid plane to 0.1"
Z End	-.75 abs	Sets the drill depth to -0.75"
Radius	1.625 abs	The radius of the bolt hole circle
Angle	9 abs	Angle of first hole from zero (0) degrees
# of Pecks for Drill	6 abs	Sets drill function for 6 pecks
Z Feedrate	10 abs	Sets Z plunge rate to 10 ipm
Tool #	3 abs	Selects Tool # 3 (0.5" drill)

**This is the end of the program.**

## 16.0 Description of TRAK K Mills

This section provides a description of TRAK K Mills.

If you purchased your ProtoTRAK SM CNC as a retrofit, please refer to the user manual that came with your machine.

### 16.1 TRAK K Mill Models

The TRAK K Mill comes in the following models:

TRAK-K2S	TRAK K2 Knee Mill, 33"x12", 3HP, w/PTSM2 CNC
TRAK-K3S	TRAK K3 Knee Mill, 32"x16", 3HP, w/PTSM2 CNC
TRAK-K4S	TRAK K4 Knee Mill, 32"x16 1/2", 5HP, w/PTSM2 CNC
TRAK-K2S-3	TRAK K2 Knee Mill, 33"x12", 3HP, w/PTSM3 CNC
TRAK-K3S-3	TRAK K3 Knee Mill, 32"x16", 3HP, w/PTSM3 CNC
TRAK-K4S-3	TRAK K4 Knee Mill, 32"x16 1/2", 5HP, w/PTSM3 CNC

The -3 designation above indicates that the machine has been fit with the Z-axis motor and ballscrew assembly for three-axis CNC operation.

### 16.2 Machine Overview

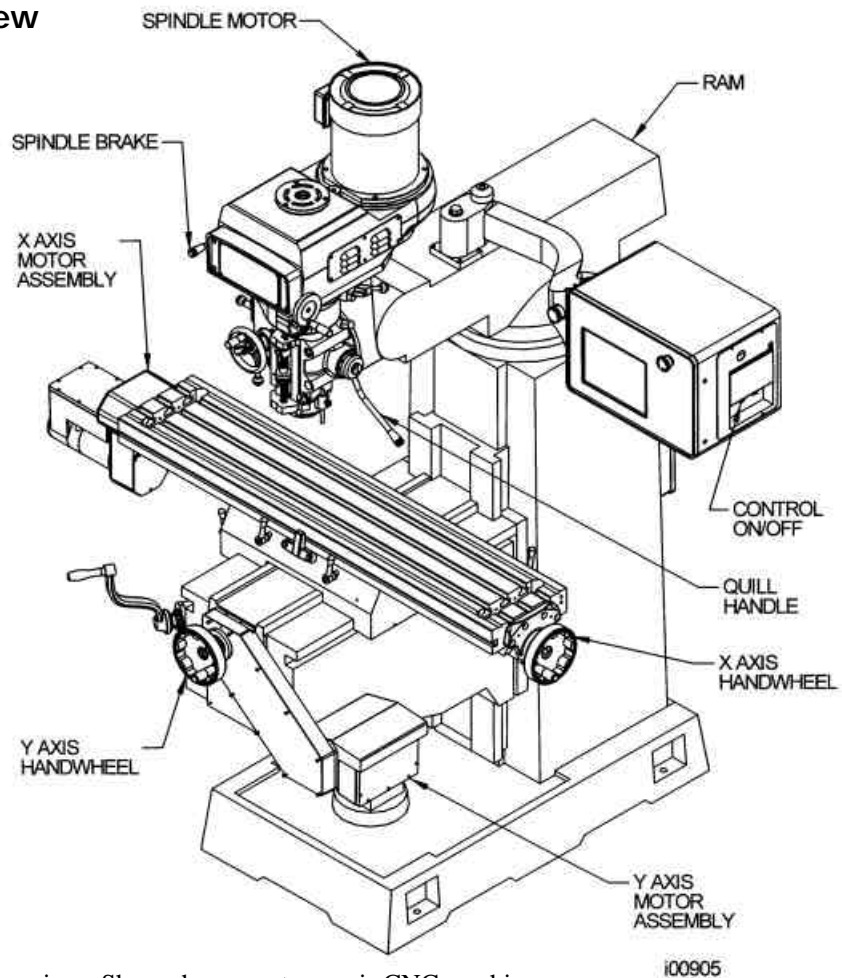

**Figure 16.2** The TRAK-K3S overview. Shown here as a two-axis CNC machine.

## 16.3 Machine Dimensions

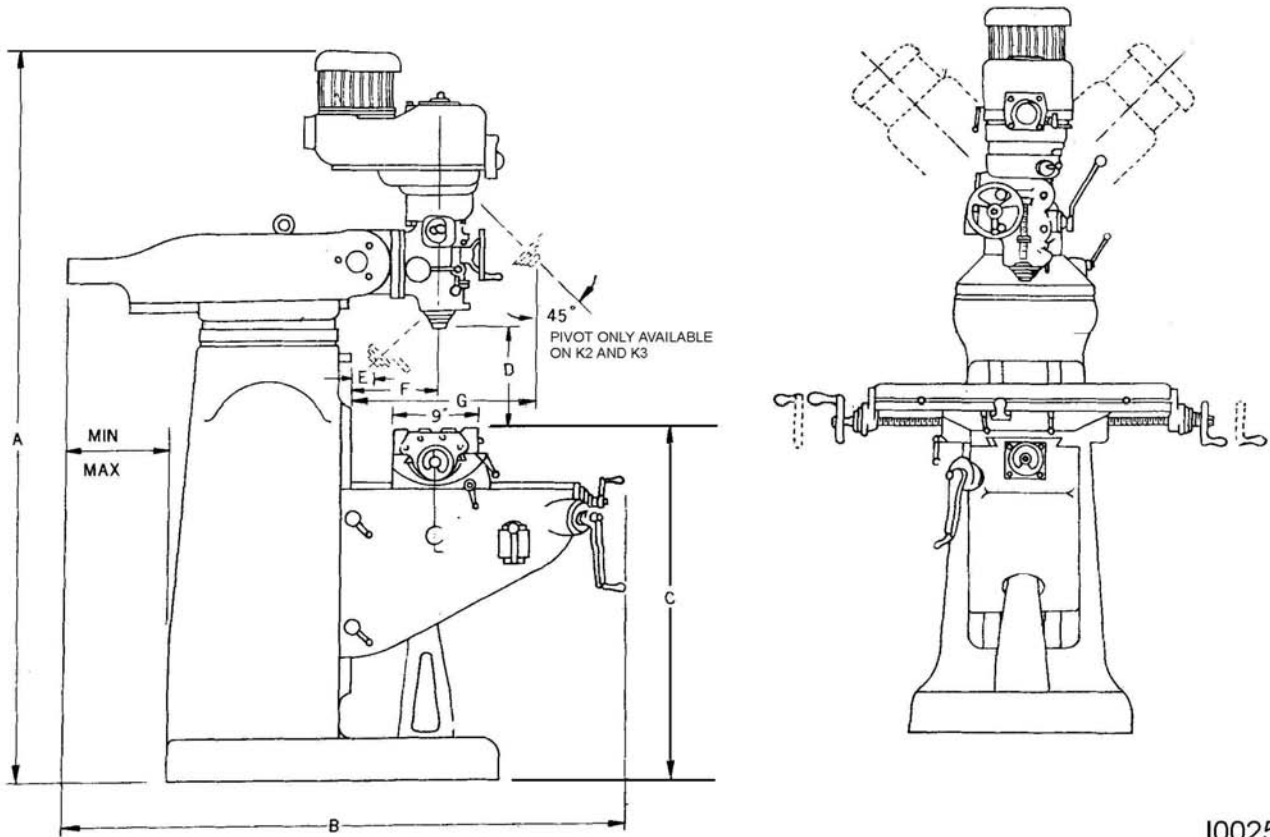

I00252

Figure 16.3 Machine dimensions.

	K2	K3	K4
Table Size	9" x 49"	10" x 50"	10" x 50"
T-Slots (number x width x depth)	5/8"x3"x2 1/2"	5/8"x3"x2 1/2"	5/8"x3"x2 1/2"
Dimension A	85"	86"	92"
Dimension B Min	54"	54"	56"
Dimension B Max	68"	78"	80"
Dimension C Min	30"	30"	33"
Dimension C Max	46"	46"	50"
Dimension D	102"	102"	102"
Dimension E	38"	40"	45"
Dimension F	24"	25"	26"
Weight (approx) net	2400 lb.	3060 lb.	3630 lb.
Weight (approx) shipping	2700 lb.	3360 lb.	4290 lb.
Pallet Size			
1 machine/pallet	70"x70"	70"x70"	70"x70"
2 machines/pallet	90"x66"	90"x66"	90"x66"

## 16.4 Machine Specifications

	K2	K3	K4
Movement & Ranges (X, Y, Z axis)	33"x12"x16"	32"x16"x16"	32"x16.5"x16.5"
Quill Travel (maximum)	5"	5"	5"
Spindle Head			
a. Quill Diameter	3 3/8"	3 3/8"	3 15/16"
b. Spindle Taper	R8	R8	NST40
c. Speed Range	60-4200 RPM	60-4200 RPM	70-3800 RPM
d. Spindle Nose to Table (max part ht.)	16"	16"	16"
e. Quill Feeds Per Rev. of Spindle	0.0015"	0.008"	0.006"
Tilt	45° Forward	45° Back	90° Right
	90° Right	90° Left	90° Left
Spindle Motor			
Power	3 Hp	3 Hp	5 Hp
Voltage	220/440V	220/440V	220/440V
Phase/Cycle	3 Phase, 50/60 Hz	3 Phase, 50/60 Hz	3 Phase 50/60 Hz
Current	4.3 Amp	4.3 Amp	7 Amp
Maximum Weight of Workpiece	750 lb.	850 lb.	850 lb.

## 16.5 Maximum Machining Capacities

	K2	K3	K4
Drilling Mild Steel	1 1/4"	1 1/4"	1 1/4"
Tapping	1"	1"	1"
Milling (metal removal rate/mild steel)	1 in <sup>3</sup> /min	1.5 1n <sup>3</sup> /min	2 in <sup>3</sup> /min

## 16.6 Machine Options

The following options are available for TRAK K Mills. See Section 3 for a list of the CNC options.

**Chip Pan**

**Halogen Work Lamp**

**Power Draw Bar** for K4 – CAT 40 or NMTB 40

**Power Draw Bar** K2 and K3 – R8

**Riser Block**, 4", 6" or 8"

**Knee Power Feed**

## 16.7 Lubrication

### 16.7.1 Manual Lubrication

The TRAK Knee Mill X, Y, Z way surfaces and ball screws are lubricated manually with the lubrication pump located on the left side of the knee. Pull the handle fully and release 4 to 6 times at the beginning of each shift, and once every four hours of operation thereafter.

1. At the beginning of each day, check the oil level in the pump. If low, fill with SAE 30 or 30W oil.
2. Every six months of operation, apply a liberal coating of Mobile Grease-MP, or equivalent to the Z-Axis ACME screw.

**CAUTION!**

Failure to manually activate the pump at the beginning of each day may cause severe damage to the TRAK Knee Mill way surfaces and ball screws.

### 16.7.2 Head Lubrication

**Once Each Week:**

1. Fill the oil cup on the front of the head with SAE 30 or 30W oil. This oil lubricates the Hi/Lo range shifter.
2. Fill the ball oiler located in the front lower right corner of the speed hanger housing. This oil lubricates the speed changer shaft.
3. Extend the quill fully and apply a coating of SAE 30 or 30W oil to the outside diameter of the quill.

**Every Four Months:**

Apply a good grade of general-purpose grease through the grease fittings on the back of the head and on the left side of the head. The grease lubricates the low range gear set and the feed change gears respectively.

## 17.0 Machine Operation

If you purchased your ProtoTRAK SM CNC as a retrofit, please refer to the user manual that came with your machine.

### 17.1 Spindle On/Off, Forward/Reverse

The spindle switch is located on the left side of the milling head.

- Turn the Spindle switch to **left to 1** for forward (clockwise) spindle rotation if the Hi-Lo-Neutral lever is in the low position.
- Turn the Spindle switch **right to 2** for forward (clockwise) spindle rotation if the Hi-Lo-Neutral lever is in the high position.
- Turn the Spindle switch straight ahead for off.

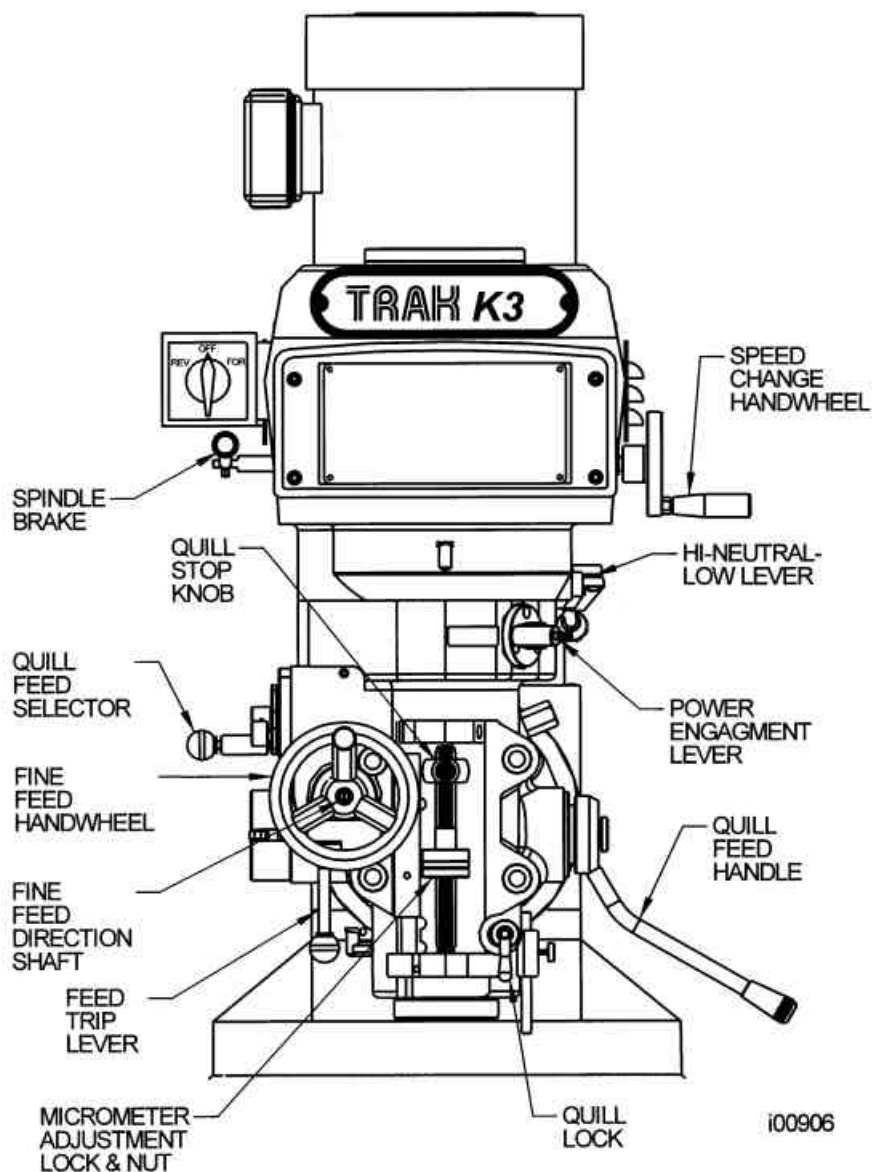

**Figure 17.0** TRAK K3 Mill head front view. Shown without the standard quill glass scale.



## 17.2 Table, Saddle, Knee/Clamps

The table clamps are located on the front of the saddle. Rotate them clockwise until snug--overtightening is not necessary.

The saddle clamp is located on the left side of the saddle. Pull forward to clamp the table until snug--overtightening is not necessary.

The knee clamps are located on the left side of the knee for the K2 and K3 mills, and on the right side for the K17.

### CAUTION!

*Do not run ProtoTRAK SM program unless the table and saddle clamps are free .*

## 17.3 Raising/Lowering the Knee

The knee is raised and lowered using the hand crank located on the left front of the knee. Clockwise rotation moves the knee up, while counterclockwise rotation moves the knee down.

Be sure the knee is unclamped before raising or lowering.

## 17.4 Spindle Brake

The mechanical spindle brake is activated pulling it down, or pushing it up. When the lever arm is in the horizontal position, the brake is off.

### CAUTION!

*Be certain that the spindle brake is released before starting the motor. Never attempt to activate the spindle brake when the motor is on.*

## 17.5 Draw Bar

The draw bar holds the R8 or #40 NST tool holders into the spindle taper. The bar has a 5/8-11 right hand thread and should be tightened with a 23mm wrench from the top of the head. When tightening, it is necessary to activate the spindle brake (See 17.4 above). If the tool holder does not release from the spindle, lightly tap on the top of the bar to dislodge the tool.

## 17.6 Changing Speeds: High-Low-Neutral Level

The spindle speed may be varied within a low range (70-500 RPM) or high range (600 to 4200 RPM). The range selection is made through the High-Low-Neutral Lever.

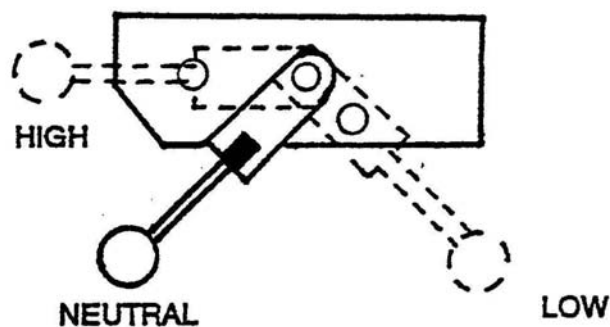

Figure 17.6

**CAUTION!**

*Never attempt to change the range selection through the High-Low-Neutral lever when the spindle is rotating. Be certain the spindle ON/OFF switch is in the Off position.*

Rotate the spindle by hand to help engage the lever into the high or low position.

*Note: Shifting from the high to low range, or low to high range changes the direction of rotation for the On/Off switch (See Section 17.1).*

### 17.7 Changing Speeds: Variable Speed

Within each speed range the spindle speed may be varied by rotating the variable speed crank.

**CAUTION!**

*Do not rotate the variable speed crank when the spindle is stationary.*

### 17.8 Operating the Quill

The quill may be moved up and down through its range with the quill feed handle. The quill may be locked into position by rotating the quill lock clockwise. Pull the handle out slightly to rotate it freely to a new position.

### 17.9 Adjusting the Quill Stop

The quill stop may be adjusted by rotating the micrometer dial nut. It is locked in place with the knurled nut.

### 17.10 Quill Feed

Several devices are used in controlling the fine quill feed process. Each of these devices are described in the 17.10.1 through 17.10.4 subsections below. Subsections 17.10.5 and 17.10.6 describe the hand and automatic feed procedures.

#### 17.10.1 Power Feed Engagement Lever

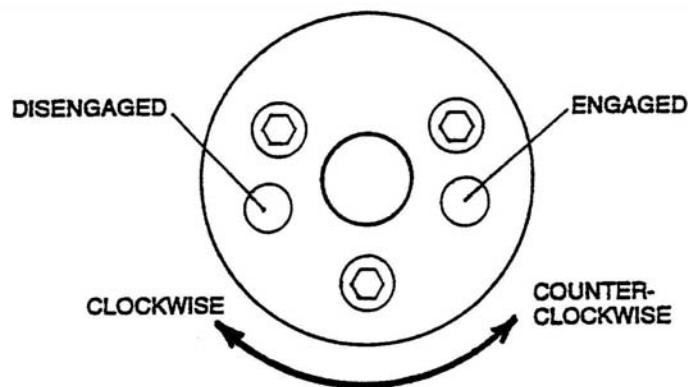

Figure 17.10.1

i00166

The power feed is engaged or disengaged with this selector. Pull out the knob and rotate it clockwise to disengage power feed. Rotate it counterclockwise to engage power feed.

**CAUTION!**

*It is recommended that the selector be engaged when the spindle is not running. Never have the feed engaged when the spindle RPM is over 3000. Always leave the selector in the disengaged position unless the feed function is being used.*

17.10.2 Fine Feed Direction Shaft

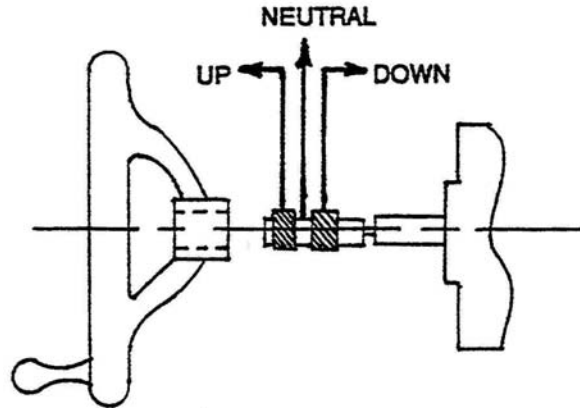

Figure 17.10.2

i00166

The direction of the fine feed is set by the position of the fine feed direction shaft. IN sets the direction down, OUT sets the direction up, and NEUTRAL in the middle.

17.10.3 Quill Feed Selector

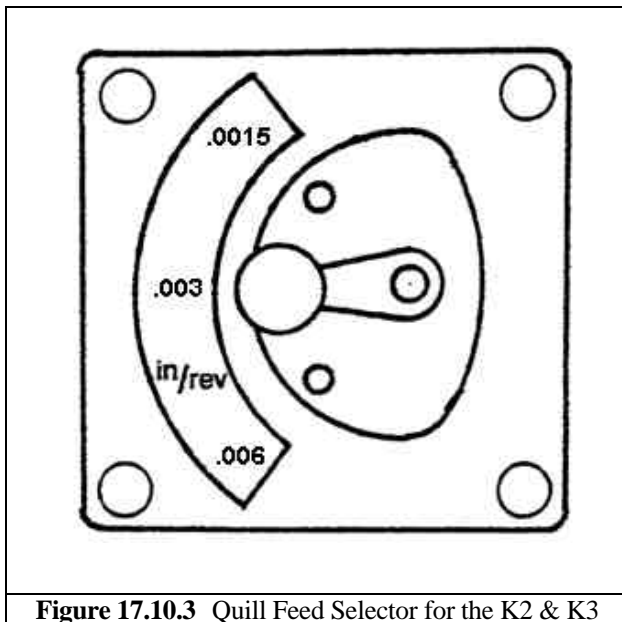

Figure 17.10.3 Quill Feed Selector for the K2 & K3

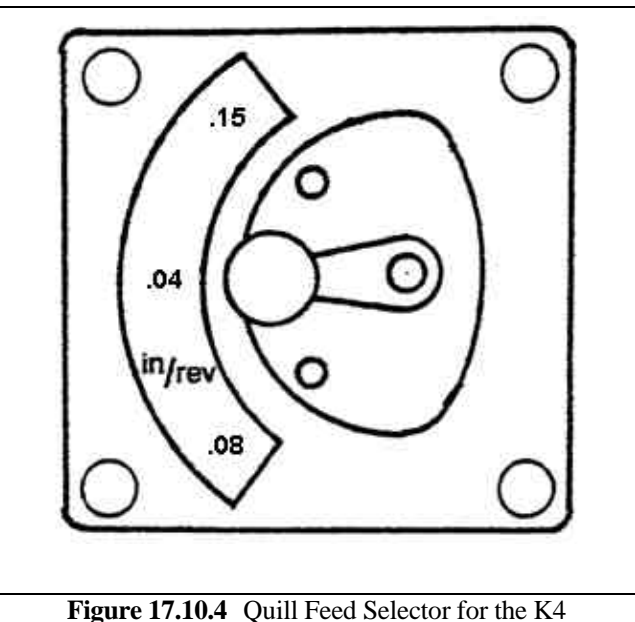

Figure 17.10.4 Quill Feed Selector for the K4

This selector is used to set the quill feed speed. The options are .002 inches per revolution of the spindle, .004 inches per revolution, and .006 inches per revolution.

To change speeds, pull the knob out and rotate the selector to the proper position. It is generally easier to change speeds with the spindle running or rotated by hand. Do not force the lever.

#### 17.10.4 Feed Trip Lever

The Feed Trip Lever stops the quill feed motion when the quill stop knob reaches the quill micrometer dial.

Move the lever to the left to engage, or to the right to disengage.

#### 17.10.5 Fine Hand Quill Feed

1. Disengage the Power Feed Engagement Lever (See 17.10.1).
2. Set the fine feed direction shaft to the neutral position (See 17.10.2).
3. Rotate the Fine Feed handwheel.

#### 17.10.6 Fine Automatic Quill Feed

1. Be certain the quill lock is off.
  2. Set the quill micrometer dial to the proper depth (See 17.10.4).
  3. Engage the Power Feed Engagement lever when the motor is stopped (See 17.10.1).
17. Select proper quill feed (See 17.10.3).

# Checklist

In order for SWI to process a trainee for certification, all aspects of the training on the product must be successfully completed to the satisfaction of the trainer and the trainee. Please fill out and sign this document when the training is completed and send it to Ruby Yonan at Southwestern Industries. Upon receipt, the certification document will be created and sent to the trainee.

**Complete the following information:**

Full name of person to receive certification \_\_\_\_\_

Company name and complete address \_\_\_\_\_  
 \_\_\_\_\_  
 \_\_\_\_\_

Name of trainer \_\_\_\_\_

Machine Name \_\_\_\_\_

Machine Model \_\_\_\_\_

Machine Serial No. \_\_\_\_\_

Place a checkmark next to each of the completed training areas:

<input type="checkbox"/>	1.	Definitions, terms and concepts for Axes, Planes and Referenced Data
<input type="checkbox"/>	2.	The DRO Mode, and using the machine tool manually
<input type="checkbox"/>	3.	Programming; using all canned cycles
<input type="checkbox"/>	4.	Editing capabilities
<input type="checkbox"/>	5.	Using all of the program storage and retrieval choices
<input type="checkbox"/>	6.	Converting data from other program sources
<input type="checkbox"/>	7.	Setting up tools and using the tool table
<input type="checkbox"/>	8.	Programming, setting up and running a complete part
<input type="checkbox"/>	9.	Understanding networking capabilities
<input type="checkbox"/>	10.	Using Math Help
<input type="checkbox"/>	11.	Using AGE capability in programming profiles
<input type="checkbox"/>	12.	Using Windows functions for non programming functions
<input type="checkbox"/>	13.	A review of related SWI products and compatibility to the SM control

\_\_\_\_\_  
 Trainee Signature Date

\_\_\_\_\_  
 Trainer Signature Date

# ProtoTRAK SM Training

Southwestern Industries, Inc

# Trav-A-Dial & TRAK Warranty Policy

## Warranty

Trav-A-Dial and TRAK products are warranted to the original purchaser to be free from defects in workmanship and materials for the following periods:

Product	Warranty Period	
	Materials	Factory Labor
New Trav-A-Dial	1 Year	1 Year
New TRAK	1 Year	1 Year
Any EXCHANGE Unit	90 Days	90 Days

The warranty period starts on the date of the invoice to the original purchaser from Southwestern Industries, Inc. (SWI) or their authorized distributor.

If a unit under warranty fails, it will be repaired or exchanged at our option for a properly functioning unit in similar or better condition. Such repairs or exchanges will be made FOB Factory/Los Angeles or the location of our nearest factory representative or authorized distributor.

## Disclaimers of Warranties

- This warranty is expressly in lieu of any other warranties, express or implied, including any implied warranty of merchantability or fitness for a particular purpose, and of any other obligations or liability on the part of SWI (or any producing entity, if different).
- Warranty repairs/exchanges do not cover incidental costs such as installation, labor, freight, etc.
- SWI is not responsible for consequential damages from use or misuse of any of its products.
- Trav-A-Dial/TRAK products are precision mechanical/electromechanical measurement systems and must be given the reasonable care that these types of instruments require:
- Replacement of chip scrapers and wipers is the responsibility of the customer. Consequently, the warranty does not apply if chips have been allowed to enter the mechanism.
- Accidental damage, beyond the control of SWI, is not covered by the warranty. Thus, the warranty does not apply if an instrument has been abused, dropped, hit, disassembled or opened.
- Improper installation by or at the direction of the customer in such a way that the product consequently fails, is considered to be beyond the control of the manufacturer and outside the scope of the warranty.