

# TRAK Machine Tools Site Preparation Guide TRAK TMC10

## Service Manual Link:

[https://www.southwesternindustries.com/media/manuals/31551\\_manual.pdf](https://www.southwesternindustries.com/media/manuals/31551_manual.pdf)

## Programming Manual Link:

[https://www.southwesternindustries.com/media/manuals/31550\\_manual.pdf](https://www.southwesternindustries.com/media/manuals/31550_manual.pdf)

Before an Authorized Field Service Technician can perform the machine's final checkout, the following requirements must be met:

- The machine must be in position and placed on its rest pads.
- To move the machine while on the pallet, a 15000 lb. forklift with a 24" load center & 6' fork extensions is required. Depending on the load center or rating of the forklift, a larger forklift may be required. The center of gravity (CG) of the machine while on the pallet is ~56" from the edge of the pallet.
- The TMC must be lifted from either the left or right hand sides. Make certain that the forks are squarely in the lifting cutouts beneath the machine. See the figures below.
- The TMC may be lifted via a crane with 4 points shown in figure 7 and 8.
- Once the machine is raised from the pallet, thread the adjusting screws into the bed casting. Thread the leveling screws down approximately 1.25" as measured from the bottom of the leveling bolt to the bottom of the casting. The TMC should be placed on the 4 leveling pads labeled L1, R1, L2 and R2. The leveling screws labeled L3 and R3 should be threaded in but not touching the pad. They will be adjusted during installation.
- The machine must be wired (refer to the installation and service manual for additional information). Make sure to follow our grounding recommendations.
- The machine must have air hooked up. We strongly recommend that a water separator or air dryer be installed upstream of the TMC air supply.

## Space & Weight

- Floor area (W x L) = 174.50" x 135"
- Height = 90" (min) / 106.5" (max)
- Footprint (W x L) (coolant tank in place) = 111" x 135"
- Net (approx.) Weight = 9900 lbs.
- Shipping (approx.) Weight = 10250 lbs.
- Pallet Size = 91" x 119"
- The floor area encompasses the space required to position the chip container and have the electrical cabinet or side doors open along the X axis.
- A solid and level foundation to maintain approximately 9900 lbs. plus the weight of the workpiece (maximum total of ~ 11500 lbs.) is required. Six leveling screws are provided.
- Minimum doorway width is 88" and minimum height is 90" that the TMC can fit through (assumes Z cable carrier collapsed and Z axis motor removed). The 90" height dimension can be reduced to 84" if further items are removed or adjusted.\*

*\*Additional charges may apply.*

## Electrical

- With the 8k spindle a separate 208 VAC (200 to 240 V is acceptable), 68 amps, 60 Hz, 3 phase circuit is required. Note – Current can be as high as 87 amps with all options ordered – CTS (+14 amps, 4<sup>th</sup> axis (+5 amps)
- With the 12k spindle a separate 208 VAC (200 to 240 V is acceptable), 69 amps, 60 Hz, 3 phase circuit is required. Note – Current can be as high as 88 amps with all options ordered – CTS (+14 amps), 4<sup>th</sup> axis (+5 amps)
- With the 8k spindle a separate 480 VAC (432 to 528 V is acceptable), 46 amps, 60 Hz, 3 phase circuit is required. Note – 46 amps based nominal rated current of transformer.
- With the 12k spindle A separate 480 VAC (432 to 528 V is acceptable), 46 amps, 60 Hz, 3 phase circuit is required. Note – 46 amps based nominal rated current of transformer
- A step-down transformer is required for 480V. TMT provides this as an option.
- Machine tool should be earth grounded with a dedicated 8-foot long copper rod. The 6-gage ground wire should run from the copper rod to grounding location in the electrical cabinet. See figures 9 and 10.

## Air

- ½" ID minimum air connection is required.
- Air pressure must be a minimum of 90 psi.
- Air – 2.5 CFM (at 90 psi), 18 SCFM

**TRAK Machine Tools**  
**Site Preparation Guide**  
**TRAK TMC10**

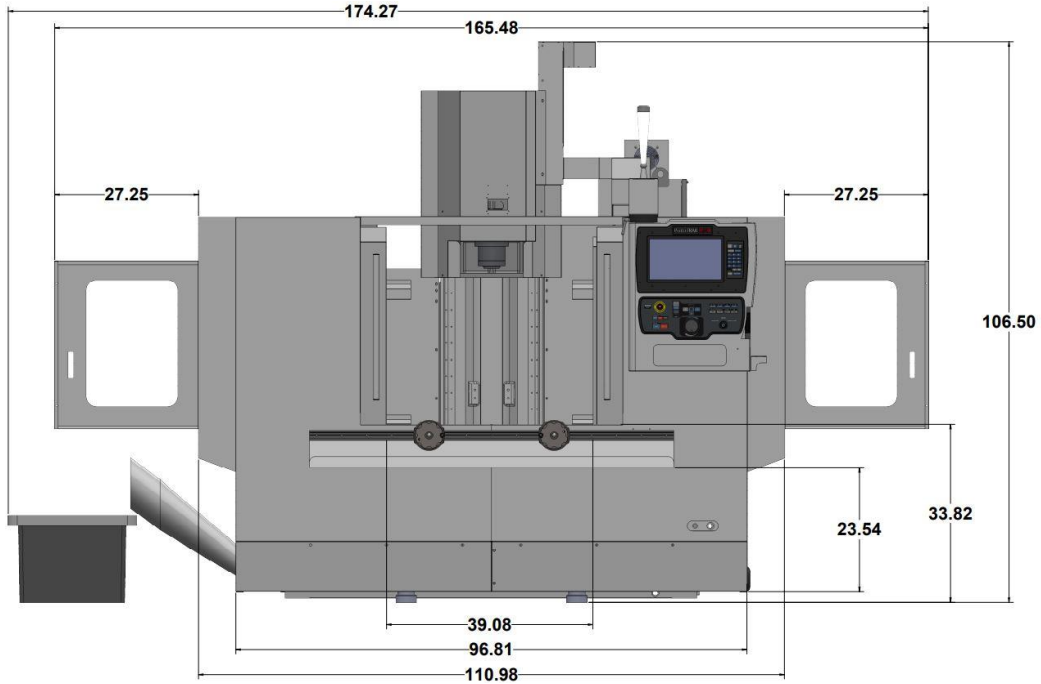

**Figure 1 – Front View of Machine**

**TRAK Machine Tools**  
**Site Preparation Guide**  
**TRAK TMC10**

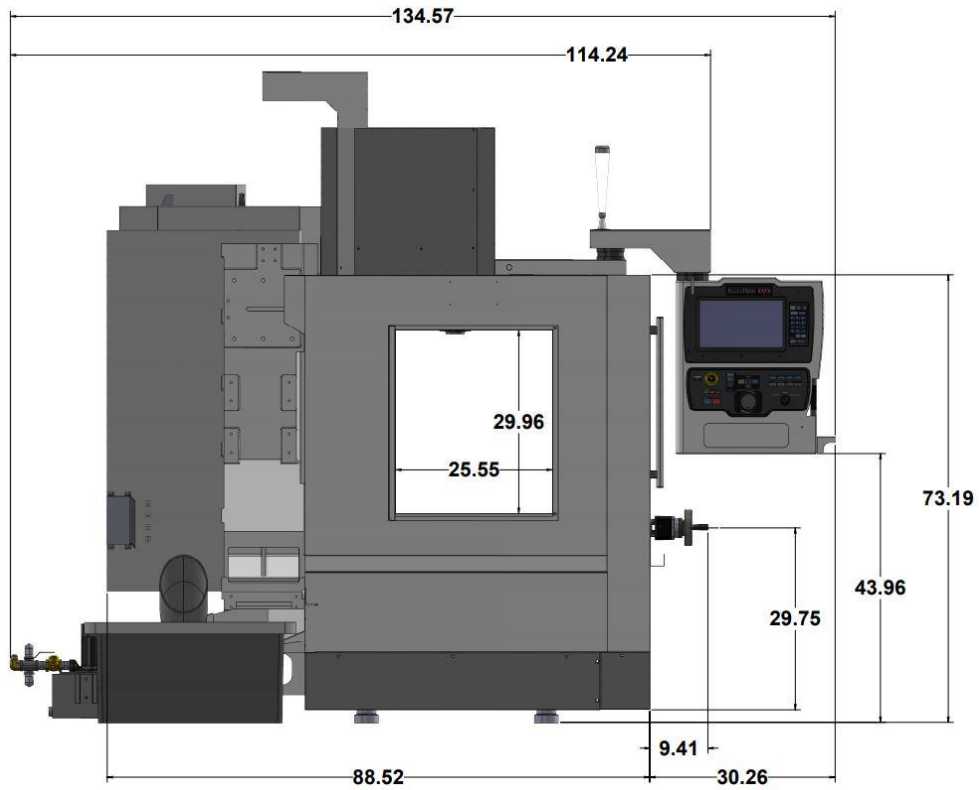

**Figure 2 – Side View of Machine**



**Figure 3 – Lifting the TMC**

**TRAK Machine Tools**  
**Site Preparation Guide**  
**TRAK TMC10**

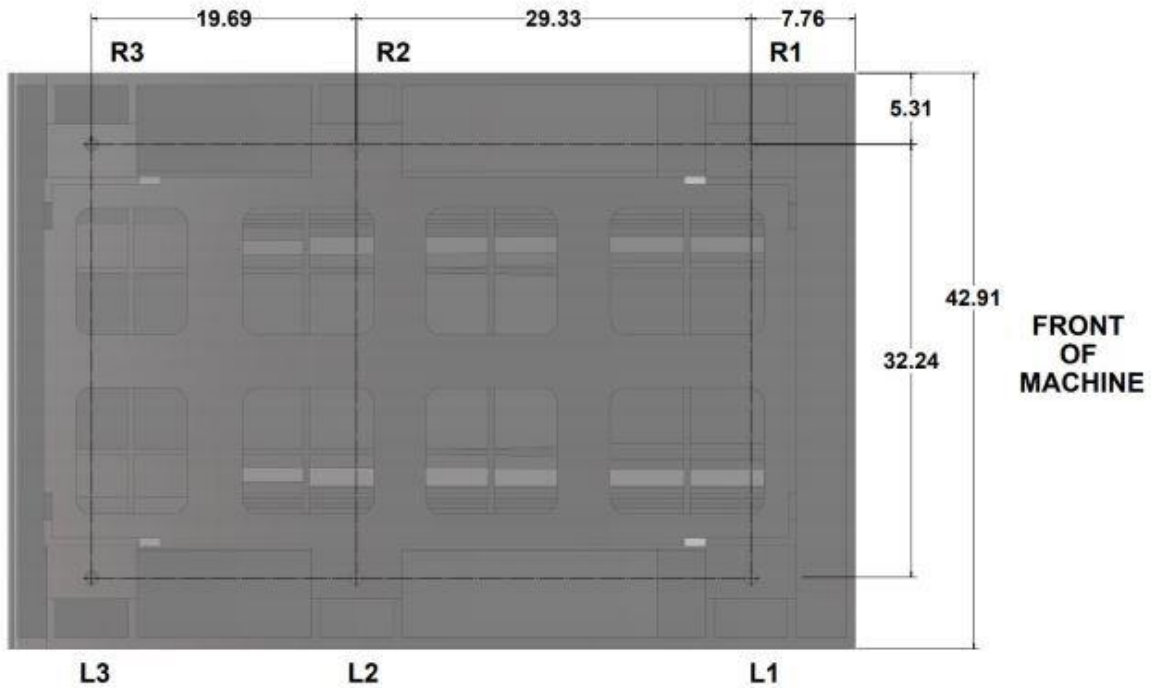

**Figure 4 – Lifting the TMC**



**Figure 5 – Lifting the TMC**

**TRAK Machine Tools**  
**Site Preparation Guide**  
**TRAK TMC10**



**Figure 6 – Leveling Pad Locations**

If you would like to lift the machine with a crane, the following figures show the lifting points. Note – Brackets that attach to the two-column casting and shown in figure 8 are not provided with the machine.

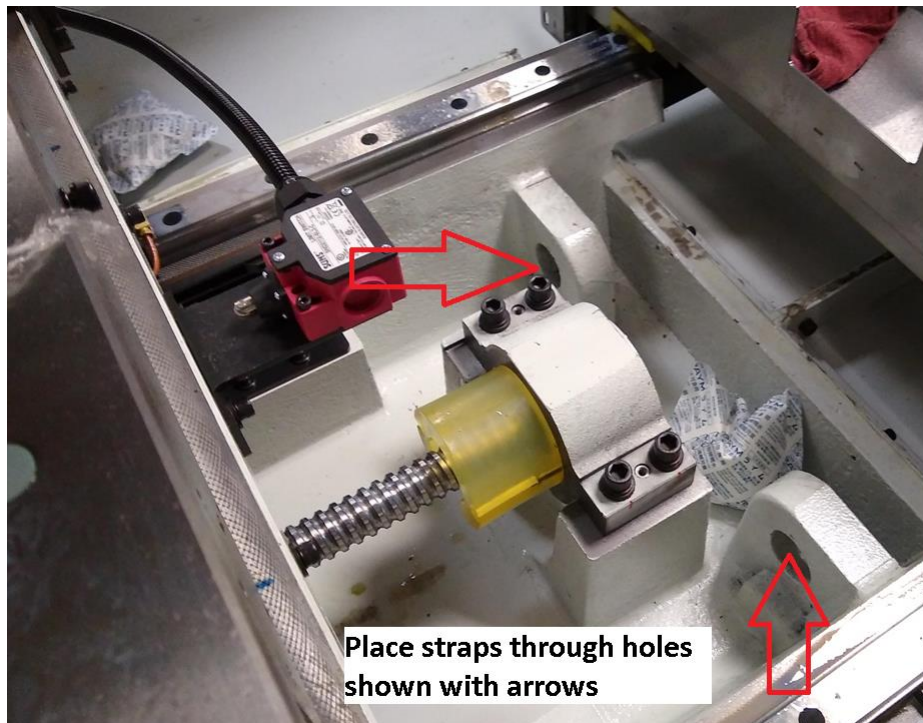

**Figure 7 – Lifting Machine with Straps**

**TRAK Machine Tools**  
**Site Preparation Guide**  
**TRAK TMC10**

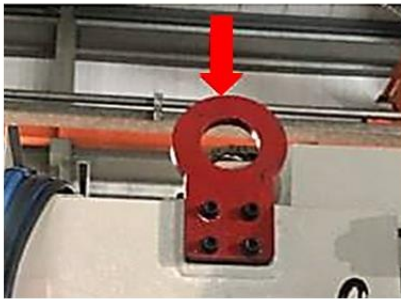
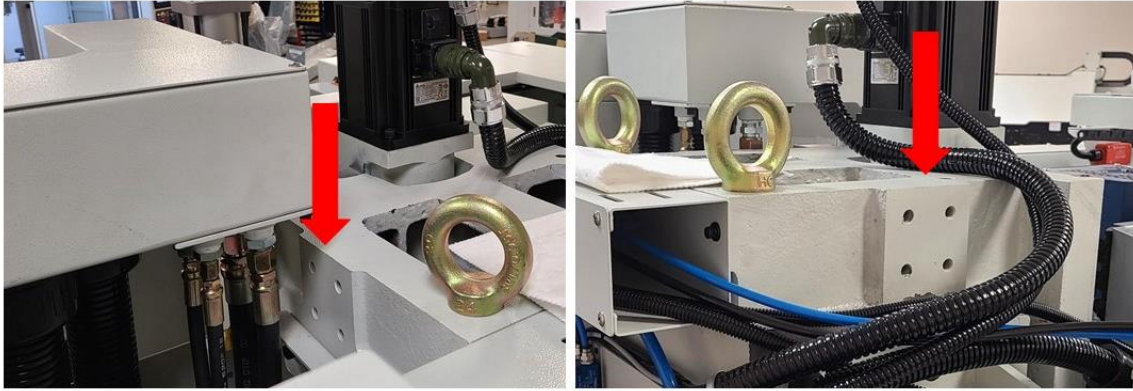

**Figure 8 – Lifting Machine on Top of Column**

Both brackets mount with (4) M12 bolts using a 50mm X 50mm bolt pattern.

**TRAK Machine Tools**  
**Site Preparation Guide**  
**TRAK TMC10**

**Electrical Connections**

**Main Power to the Machine Connections**

The 3 phase 208 voltage (200 – 240 V is acceptable) is connected to L1, L2 and L3 at the main power switch inside the electrical box. Connect the ground wire as shown in the figure 9.

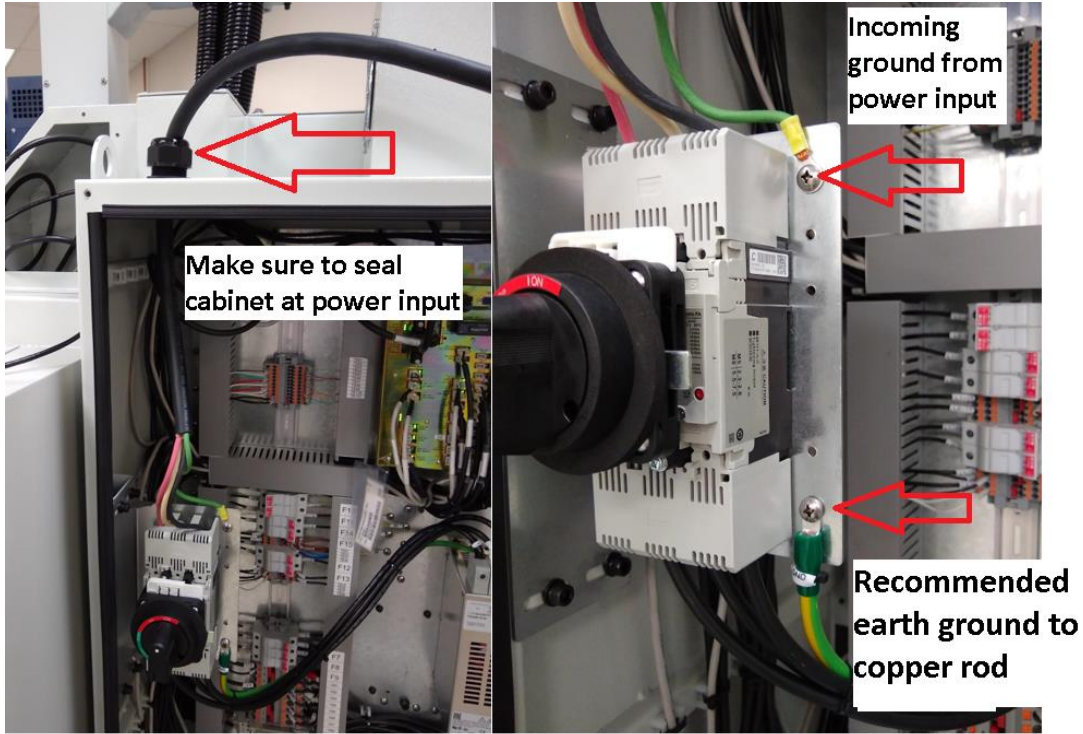
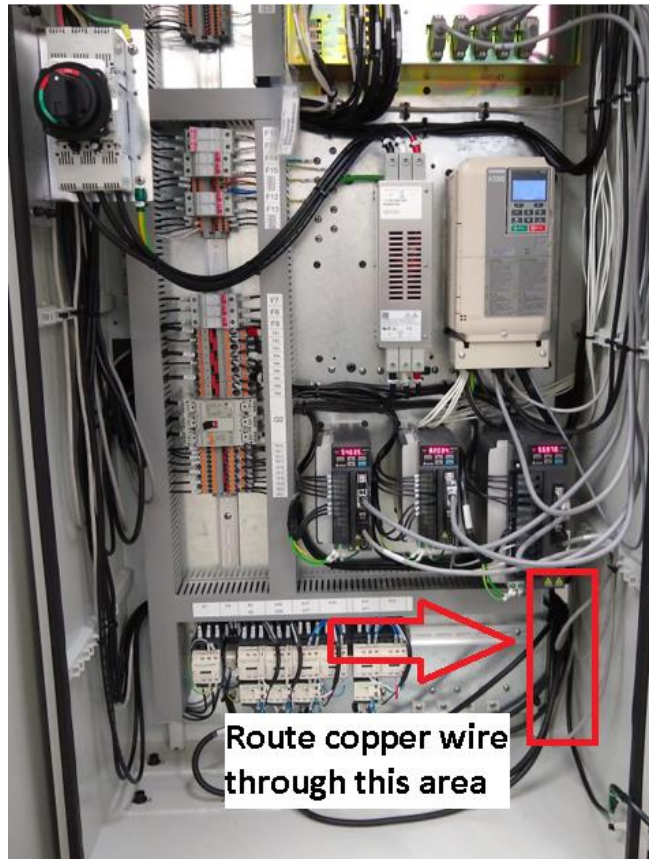

**Figure 9 – Connect the Ground Wire**

**Machine Grounding**

It is strongly recommended that the machine be earth grounded. A dedicated copper rod 8 feet or so in length should be driven into the ground near the TMC. A ground wire should then be run from the location shown in figure 9. The copper wire should exit the electrical cabinet in the lower right-hand corner as shown in figure 10. Make sure the foam where the copper wire goes through seals the cabinet from external debris. The wire should be 6 gage in size.

**TRAK Machine Tools**  
**Site Preparation Guide**  
**TRAK TMC10**



**Figure 10 – Exit Location for Ground Wire to Copper Rod**