

TRAK[®] VMC2 ProtoTRAK[®] RMX CNC

Safety, Installation, Maintenance, Service and Parts List

Document:	31552
Version:	121222

Covers Current Model:

- TRAK VMC2

TRAK MACHINE
TOOLS



SOUTHWESTERN INDUSTRIES, INC.

2615 Homestead Place

Rancho Dominguez, CA 90220-5610 USA

T | 310.608.4422 | F | 310.764.2668

Service Department: 800.367.3165

e-mail: sales@trakmt.com | service@trakmt.com | web: www.trakmt.com

Copyright © 2021, Southwestern Industries, Inc. All rights are reserved. No part of this publication may be reproduced, stored in a retrieval system, or transmitted, in any form or by any means, mechanical, photocopying, recording or otherwise, without the prior written permission of Southwestern Industries, Inc.

While every effort has been made to include all the information required for the purposes of this guide, Southwestern Industries, Inc. assumes no responsibility for inaccuracies or omission and accepts no liability for damages resulting from the use of the information contained in this guide.

All brand names and products are trademarks or registered trademarks of their respective holders.

TRAK Machine Tools

Southwestern Industries, Inc.

2615 Homestead Place

Rancho Dominguez, CA 90220-5610

Phone 310.608.4422 ▪ Fax 310.764.2668

Service Department

Phone 800.367.3165 ▪ Fax 310.886.8029

Web: www.trakmt.com

Table of Contents

1.0	Safety	1
1.1	Safety Publications	1
1.2	Danger, Warning, Caution, Note Labels & Notices As Used In This Manual	1
1.3	Tool Room OP and Production OP	7
1.4	Safety Precautions.....	8
2.0	Installation of TRAK VMC2 Series Machining Centers	10
2.1	Installation Requirements	10
2.2	Overall Dimensions VMC2 (inches)	10
2.3	Cleaning the VMC2	14
2.4	Lifting and/or Placing the VMC2	15
2.5	Uncrating the VMC2.....	17
2.6	Leveling Procedure	18
2.7	Shortages: Inventory Checklist.....	18
2.8	Electrical Connection	19
2.8.1	Transformer Option	19
2.8.2	Single Phase Power Option.....	21
2.9	Connection	21
2.9.1	Air Regulator/Air Pressure Switch/Solenoid Assembly Mounting	21
2.9.1.1	Pressure Switch Connection	22
2.9.2	Air Connection.....	23
2.9.3	Air Regulators and Solenoids	23
2.10	Installation Checklist.....	24
2.11	Coolant and Coolant Wash System	27
2.12	Air Blast System	27
2.13	Lubrication.....	27
2.13.1	Way Lubrication	27
2.13.2	Other VMC2 Lubrication Points.....	29
2.14	TRAK VMC2 Machine Specifications	30
2.15	Maximum Spindle Torque & HP	31
2.16	ProtoTRAK RMX Euclid Block Procedure	32
3.0	Troubleshooting by Symptom	34
3.1	Problems Relating to Machining Results	34
3.1.1	Poor Finish	34
3.1.2	Circles Out of Round	34

3.1.3	Parts Have Incorrect Dimensions	35
3.1.3.1	Every Part Has the Same Error	35
3.1.3.2	The Dimensional Errors Are Random or Accumulate in Size Over the Part Program Run 36	36
3.2	Motion Related Problems	36
3.2.1	Run Away Axis.....	36
3.2.2	Axis Will Not Jog with Electronic Handwheel	36
3.2.3	Searching Axis.....	37
3.2.4	Homing Error – Axis, Tool Changer	37
3.3	Computer Related Issues	38
3.3.1	USB Not Working on Pendant Enclosure	38
3.3.2	Programming Panel Does Not Power On.....	39
3.3.3	Blank Display.....	40
3.3.4	White Display	41
3.3.5	System Will Not Boot	41
3.3.6	E-Stop Error	42
3.3.7	Overlay Keys Not Responding.....	43
4.0	Tool Changer Problems.....	45
4.1	Automatic Tool Changer (ATC) Will Not Move	45
4.2	Spindle Will Not Orientate Properly	46
4.3	Tool Will Not Clamp or Unclamp in the Spindle.....	46
4.4	Service Codes	47
4.4.1	Section A - Software Code Details.....	49
4.4.1.1	CODE 33: Software ID.....	49
4.4.1.2	CODE 141: Load Configuration File from USB Flash Drive	49
4.4.1.3	CODE 142: Save Configuration File to USB Flash Drive	49
4.4.1.4	CODE 316: Update Software	50
4.4.1.5	CODE 318: Activate Converters or Options.....	50
4.4.2	Section B - Machine Set-Up Code Details.....	50
4.4.2.1	CODE 123: Calibration	50
4.4.2.2	CODE 128: Input Backlash Constant.....	50
4.4.2.3	CODE 134: Friction Feed Forward Constant.....	50
4.4.2.4	Code 400: Update Foreign Language MLS Files	50
4.4.2.5	Code 505: Over Travel Limits	50
4.4.2.6	Code 510: Electronic Spindle Setup	51

4.4.2.7	Code 520: Set Tool Change Locations.....	51
4.4.3	Section C - Diagnostic Code Details.....	52
4.4.3.1	Code 54: Program Continuous Run.....	52
4.4.3.2	Code 81: Program Panel Test.....	52
4.4.3.3	Code 131: Manual DRO	52
4.4.3.4	CODE 132: Electronic Handwheel Test.....	52
4.4.3.5	Code 314: Toggle Test Lights 'On' in Status Line.....	53
4.4.3.6	Code 319: Error Log	53
4.4.3.7	Code 326: Error Message Display	53
4.4.3.8	Code 327: Display Memory Check	53
4.4.4	Section D - Operator Defaults/Options Codes Details	53
4.4.4.1	Code 79: Beeper On/Off	53
4.4.4.2	Code 521 - Check Control /Indexer IO	53
4.4.4.3	Code 530: Set Machine and Computer Module Serial Numbers	54
4.5	Critical Service Codes that Must Be Performed	54
5.0	Diagnostics.....	55
5.1	The Machine Tool & Set-Up	55
5.1.1	The Milling Machine Checklist	55
5.1.2	A Special Word About Linear Guides	55
5.1.3	Lubrication	56
5.1.4	Machining Set-Up	56
5.1.4.1	Spindle Speeds.....	56
5.1.4.2	Feedrates	57
5.2	The Mechanical Drive Train.....	57
5.2.1	Ballscrew Alignment.....	57
5.2.2	Protecting the Axis from a Crash.....	57
5.2.3	Z Axis Mechanical Brake	57
5.2.4	Linear Guides	58
5.2.5	Lubrication	58
5.2.6	Way Covers.....	58
6.0	Procedure for Replacements & Maintenance	59
6.1	Replacements	59
6.1.1	X Axis Motor Replacement.....	59
6.1.1.1	Removal of the X Motor	59
6.1.1.2	Installation of the X Motor	61

6.1.2	Y Axis Motor Replacement.....	62
6.1.2.1	Removal of the Y Motor	62
6.1.2.2	Installation of the Y Motor	63
6.1.3	Z Axis Motor Replacement.....	63
6.1.3.1	Removal and Replacement of the Z Motor.....	63
6.1.4	AC Spindle Drive Replacement.....	66
6.1.5	Programming Panel, Run Panel and Computer Module Replacement	67
6.1.5.1	Programming Panel Replacement	67
6.1.5.2	Pendant Run Panel Replacement.....	68
6.1.5.3	Pendant Hand Wheel, Key Lock Switch or Emergency Off Knob Replacement.....	69
6.1.5.4	Computer Module Replacement.....	69
6.1.5.5	VMC2 Computer Components.....	70
6.1.6	Updating the Pendant and CM Software	70
6.1.7	Adding Solid State Drive (SSD) Memory Option	70
6.1.8	Cable Routing on Machine	73
6.1.9	Maintenance.....	73
6.1.9.1	How to Clean the Touchscreen.....	73
6.1.9.2	Periodic Maintenance.....	74
6.1.10	Calibration	74
6.1.10.1	Introduction	74
6.1.10.2	Set Up Calibration Test	74
6.1.11	Auto Tool Changer Maintenance	76
6.1.11.1	ATC Cylinder Initial Adjustments.....	76
6.1.11.2	ATC Door Assist Cylinder Initial Adjustments	77
7.0	Introduction to Self-Service	78
7.1	When You Have a Service Problem	78
7.1.1	Communication with the SWI Customer Service Group.....	78
7.2	Replacements	78
7.2.1	Exchange Program.....	78
7.2.2	Return Material Authorization (RMA) Number	79
8.0	Appendix	80
8.1	Pneumatic System Drawing – 27563-1.....	80
8.2	Electrical Enclosure Assembly Drawing – 29103-22.....	87
	TRAK Warranty Policy.....	95

1.0 Safety

The safe operation of the TRAK VMC2 depends on its proper use and the precautions taken by each operator.

- Read and study this manual and the ProtoTRAK VMC2 Programming, Operating, and Care Manual. Be certain every operator understands the operation and safety requirements of this machine before its use.
- Never run the machine with enclosure doors open when in production ops.
- Always wear safety glasses and safety shoes.
- Always stop the spindle and check to ensure the CNC control is in the stop mode before changing or adjusting the tool or workpiece.
- Never wear gloves, rings, watches, long sleeves, neckties, jewelry, or other loose items when operating or around the machine.
- Use adequate point of operation safeguarding. It is the responsibility of the employer to provide and ensure point of operation safeguarding per OSHA 1910.212 - Milling Machine.

1.1 Safety Publications

Refer to and study the following publications for assistance in enhancing the safe use of this machine.

Safety Requirements for Machining Centers and Automatic, Numerically Controlled Milling, Drilling and Boring Machines (ANSI B11.23-2002) (R2007). Available from The American National Standards Institute, 1819 L Street N.W., Washington D.C. 20036

Concepts and Techniques of Machine Safeguarding (OSHA Publication Number 3067). Available from The Publication Office - O.S.H.A., U.S. Department of Labor, 200 Constitution Avenue, NW, Washington, DC 0210.

1.2 Danger, Warning, Caution, Note Labels & Notices As Used In This Manual

DANGER - Immediate hazards that **will** result in severe personal injury or death. Danger labels on the machine are red in color.

WARNING - Hazards or unsafe practices which *could* result in severe personal injury and/or damage to the equipment. Warning labels on the machine are orange in color.

CAUTION - Hazards or unsafe practices, which *could* result in minor personal injury or equipment/product damage. Caution labels on the machine are yellow in color.

NOTE - Call attention to specific issues requiring special attention or understanding.

Safety & Information Labels Used on The TRAK VMC2 Milling Machines

It is forbidden by OSHA regulations and by law to deface, destroy or remove any of these labels.

SAFETY INSTRUCTIONS

1. Read and understand the Operator's Manual and all warnings on this sign before operating machine.
2. Machine should only be operated by qualified personnel that have been trained in the operation and use of this machine.
3. Machine starts and moves automatically. Never place any part of your body near or on moving parts of this machine.
4. Stop spindle completely before touching the tool, work piece, or spindle.
5. Do not operate machine unless all guards, interlocks, and safety devices are installed and functioning.
6. Always clamp work piece and tool securely. Avoid excessive feeds and spindle speeds.
7. Wear safety glasses, shoes, and hearing protection when operating machine.
8. Remove rings, watches, jewelry and loose fitting clothes. Keep hair away from moving parts of the machine.
9. Installation and service must be performed by qualified personnel only, following instructions in the Maintenance Manual. Turn off and lock-out the power at the main electrical panel before servicing.
10. It is the responsibility of the user to be sure that this machine is in safe operating condition at all times, and that the operator follows the safe operating procedures described in the Operator and Maintenance Manuals.

Do not remove or disfigure this sign. S-81140

TRAK MACHINE TOOLS
 SOUTHWESTERN INDUSTRIES, INC.
 Service: 800-367-3165
 Office: 800-421-6875
 www.TRAKMT.com

Instagram: @PicksTRAK_ Facebook: @PicksTRAK_ YouTube: PicksTRAK

SAFETY WARNING!

1. Hazardous voltage present in the electrical equipment of this machine. Only qualified engineers are allowed to install, test, adjust or maintain it.
2. Isolate power before install, test, adjust or maintain the electrical equipment of this machine.
3. Do Not turn on the power before the protective grounding has been securely connected.
4. Do Not change any device of this machine without permission.

FAILURE TO COMPLY WITH THE ABOVE MAY RESULT IN A SERIOUS ACCIDENT S-81879

WARNING

1. Never open door during operation.
2. Do not operate with door removed.

Failure to observe the above may result in serious injury. S-83120

WARNING

Keep hands, clothing and body clear of rotating spindle. Machine starts and moves automatically. Can cause severe injury.

1. Set control in manual mode before working near spindle.
2. Isolate machine before servicing.

S-83018

WARNING: PRESSURIZED VESSEL

THIS AIR TANK STAYS PRESSURIZED EVEN IF THE MAIN AIR IS DISCONNECTED. BEFORE DISCONNECTING THIS TANK, FIRST DISCONNECT THE MAIN AIR SUPPLY, LOWER THE FRONT DOOR ALL THE WAY DOWN, THEN RELEASE ALL AIR PRESSURE FROM THE TANK BY SLOWLY OPENING THE DRAIN VALVE LOCATED ON THE BOTTOM OF THE TANK.

CAUTION!
IN ADDITION TO THE COMPRESSED AIR, THIS TANK MAY CONTAIN SOME OIL AND WATER. USE PROPER EYE PROTECTION AND EXERCISE CAUTION WHEN OPENING THE DRAIN VALVE.

WARNING

1. IMPROPER OPERATION OR IMPROPER MAINTENANCE OF THIS MACHINE MAY CAUSE SERIOUS BODILY INJURY OR DEATH.
2. DO NOT OPERATE THIS MACHINE UNTIL YOU HAVE RECEIVED OPERATING AND SAFETY INSTRUCTIONS FROM YOUR EMPLOYER.
3. FOLLOW ALL SAFETY PRACTICES PRESCRIBED BY YOUR EMPLOYER AND OUTLINED IN THE "SAFETY, PROGRAMMING AND OPERATING MANUAL".
4. IT IS THE RESPONSIBILITY OF THE EMPLOYER TO PROVIDE AND ENSURE METHODS OF SAFEGUARDING PER ANSI B11.22-2002 (R 2007) & B11.23-2002 (R 2007)
5. THE MANUFACTURER IS NOT LIABLE (RESPONSIBLE) FOR ANY DAMAGE OR INJURY OF ANY KIND TO PERSONS OR PROPERTY CAUSED BY OR RESULTING FROM THE IMPROPER OR UNAUTHORIZED USE, OPERATION, MAINTENANCE, ALTERATION, MODIFICATION, CHANGE IN CONFIGURATION OF THIS MACHINE OR ANY OF ITS COMPONENTS, PARTS, OR THE USE OF THIS UNIT WITH ANY THIRD PARTY ACCESSORIES OR PARTS.

DO NOT REMOVE THIS SIGN FROM MACHINE

! VISE & FIXTURE WARNING !

Vise or fixture must not protrude beyond the back edge of the worktable to avoid collision with the ATC. It may not protrude more than 1.5 inches beyond the front of the worktable to avoid collision with the front door. Use SWI modified Kurt vise P/N VISE-2OPM10 or Kurt vise 3600V-INT or equivalent

FRONT

S-S1250

DOOR OPEN DOOR CLOSE

S-S1260

S-S1150



⚠ CAUTION

Check and fill drawbar intensifier monthly
Recommended oil:
ISO 32

⚠ CAUTION

1. Air pressure must be between 6 - 7kgf/cm² (85psi-100psi).
2. Filter and Lubricator must be maintained once a week.
3. Recommended Air line - 12mm (1/2 inch).

S-S2050

NOTICE

Carefully hold tooling before pressing the tool release button. Otherwise, the spindle, tooling, table and workpiece could be damaged.

S-S3062

**ISO VG 32
Slideway Oil
ONLY**

S-S1121

208 VOLTS

WARNING - HOT!

Eye protection must be worn

MAINTENANCE

ONCE A MONTH, PLEASE REMOVE THIS BACK COVER AND VACUUM OUT THE MAJORITY OF THE CHIPS IN THE ATC COMPARTMENT AREA TO PREVENT EXCESSIVE CHIP BUILDUP, WHICH MAY OTHERWISE RESULT IN A POTENTIAL ATC MALFUNCTION OR FAULT.

S-S1220

MAINTENANCE SCHEDULE

DAILY

- Remove majority of chips from around the axis slide ways, work table and way covers, especially between table and ATC.
- Empty chip tray.
- Visually check lubrication pump oil level and make sure it is always above the minimum line.
- Visually check the coolant level and add if it is low.
- Visually check the air regulator filter.

MONTHLY OR AS SPECIFIED

- Remove rear ATC and Y-axis motor compartment access covers and clean chips and other debris. Cleanup any oil or coolant accumulated on the bottom panel of the machine base.
- Visually inspect the condition of way and ball screw covers. Clean if showing chip build up.
- Check and if needed replace the air regulator filter element.
- Every two months drain and remove the coolant tank and clean inside, including pump screen. Fill with new coolant.
- Visually check the tool unclamp oil reservoir level.
- Remove all air filters in the electrical cabinet and transformer enclosure every two months and clean.

YEARLY

- Remove all covers. Vacuum chips, debris, and wipe down machine from top to bottom.
- Check backlash on each axis and adjust if needed. Refer to the machine manual for more information.
- Inspect machine for any unusual wear and play.
- Check cables and pneumatic lines for any excessive abrasions or cuts.
- Inspect the ATC air cylinder and grease the ATC linear rail bearing blocks.
- Please contact SWI Service Dept. for help with any machine maintenance procedures. Service Dept. contact number is 1-800-367-3165.

I27694-20

Safety & Information Labels Used on The TRAK Milling Machines

It is forbidden by OSHA regulations and by law to deface, destroy or remove any of these labels.

TRAK MACHINE TOOLS
SOUTHWESTERN INDUSTRIES, INC.
2615 HOMESTEAD PLACE,
RANCHO DOMINGUEZ, CA 90220

MODEL
S/N

THIS UNIT HAS _____ POWER SOURCE(S)
ELECTRICAL RATINGS:

VOLTS AMPS 3 PHASE
 60 Hz

VOLTS AMPS 1 PHASE
 60 Hz

FLA OF LARGEST MOTOR AMPS
SHORT CIRCUIT CURRENT RATING AMPS

ELECTRICAL DRAWING #:

MACHINE (ONLY) MADE IN TAIWAN

TRAK Serial Number Plate will have the specific information engraved applicable to the mill.

1.3 Tool Room OP and Production OP

TRAK's VMC2's are designed to be switchable between tool room operation and production operation. Each operation changes several parameters and methods of use to optimize the machine for each operation.

Specifically:

Production Operation

- 600 ipm rapid
- 10,000 maximum rpm
- Interlocked door
- ATC (Automatic Tool Changer) operation
- Auto spindle start after tool change
- Full 3 - Axis operation

Tool Room Operation

- 400 ipm rapid
- 5,000 maximum rpm
- Programs run with door open or closed
- No ATC operation
- Manual Spindle by operator
- Allows manual, 2 – axis and 3 – axis operation

Figure 1.3 shows the VMC2 Console Programming Panel and Run Panel. Also shown are the key lock switch to select Tool Room or Production Operation and a display of the current Operation selected.

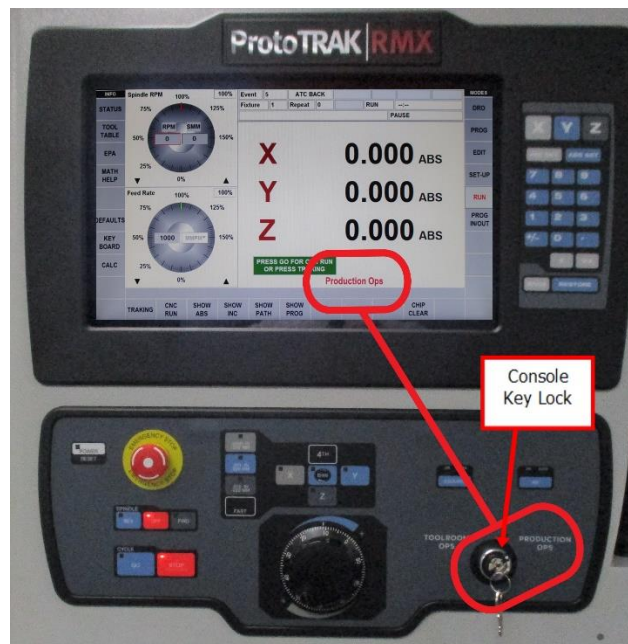

Figure 1.3 - VMC2 Pendant in "Production Ops"

1.4 Safety Precautions

1. Do not operate this machine before the TRAK VMC2 Installation, Maintenance, Service and Parts List Manual, and ProtoTRAK VMC2 Programming, Operating & Care Manual have been studied and understood.
2. Do not run this machine without knowing the function of every control key, button, knob, or handle. Ask your supervisor or a qualified instructor for help when needed.
3. Protect your eyes. Wear approved safety glasses (with side shields) at all times.
4. Don't get caught in moving parts. Before operating this machine remove all jewelry including watches and rings, neckties, and any loose-fitting clothing.
5. Keep your hair away from moving parts. Wear adequate safety headgear.
6. Protect your feet. Wear safety shoes with oil-resistant, anti-skid soles, and steel toes.
7. Take off gloves before you start the machine. Gloves are easily caught in moving parts.
8. Remove all tools (wrenches, chuck keys, etc.) from the machine before you start. Loose items can become dangerous flying projectiles.
9. Never operate a milling machine after consuming alcoholic beverages, or taking strong medication, or while using non-prescription drugs.
10. Protect your hands. Stop the machine spindle and ensure that the CNC control is in the stop mode:
 - Before changing tools
 - Before changing parts
 - Before you clear away the chips, oil or coolant. Always use a chip scraper or brush.
 - Before you make an adjustment to the part, fixture, coolant nozzle or take measurements.
 - Before you open safeguards (protective shields, etc.). Never reach for the part, tool, or fixture around a safeguard.
11. Protect your eyes and the machine as well. Don't use compressed air to remove the chips or clean the machine.
12. Disconnect power to the machine before you change belts, pulley, and gears.
13. Keep work areas well lighted. Ask for additional light if needed.
14. Do not lean on the machine while it is running.
15. Prevent slippage. Keep the work area dry and clean. Remove the chips, oil, coolant and obstacles of any kind around the machine.
16. Avoid getting pinched in places where the table, saddle, tool changer or spindle head create "pinch points" while in motion.
17. Securely clamp and properly locate the workpiece in the vise, on the table, or in the fixture. Use stop blocks to prevent objects from flying loose. Use proper holding clamping attachments and position them clear of the tool path.
18. Use correct cutting parameters (speed, feed, depth, and width of cut) in order to prevent tool breakage.

19. Use proper cutting tools for the job. Pay attention to the rotation of the spindle: Left hand tool for counterclockwise rotation of spindle, and right-hand tool for clockwise rotation of spindle.
20. After an emergency stop, release the E-stop and press the power reset button for 2 seconds to turn the servos back on.
21. Prevent damage to the workpiece or the cutting tool. Never start the machine (including the rotation of the spindle) if the tool is in contact with the part.
22. Check the direction (+ or -) of movement of the table, saddle, and quill when using the jog or power feed or ram out.
23. Don't use dull or damaged cutting tools. They break easily and become airborne. Inspect the sharpness of the edges, and the integrity of cutting tools and their holders. Use proper length tool for the job.
24. Large overhang on cutting tools when not required result in accidents and damaged parts.
25. Inspect the retention knobs for damage or excessive wear before each use.
26. Prevent fires. When machining certain materials (magnesium, etc.) the chips and dust are highly flammable. Obtain special instruction from you supervisor before machining these materials. Keep flammable materials and fluids away from the machine and hot, flying chips.
27. Always be certain that you know if the machine is in Production or Tool Room Operation (See Section 1.3).
28. Always be certain the door is closed during Run Mode when the machine is in Production Operation.

2.0 Installation of TRAK VMC2 Series Machining Centers

IMPORTANT!

Read and understand this entire installation section before beginning the VMC2 installation.

2.1 Installation Requirements

Before an Authorized Field Service Technician can perform the machine's final checkout, detailed requirements must be met. Please refer to the Site Preparation Guide for the needed set up details for your VMC2.

2.2 Overall Dimensions VMC2 (inches)

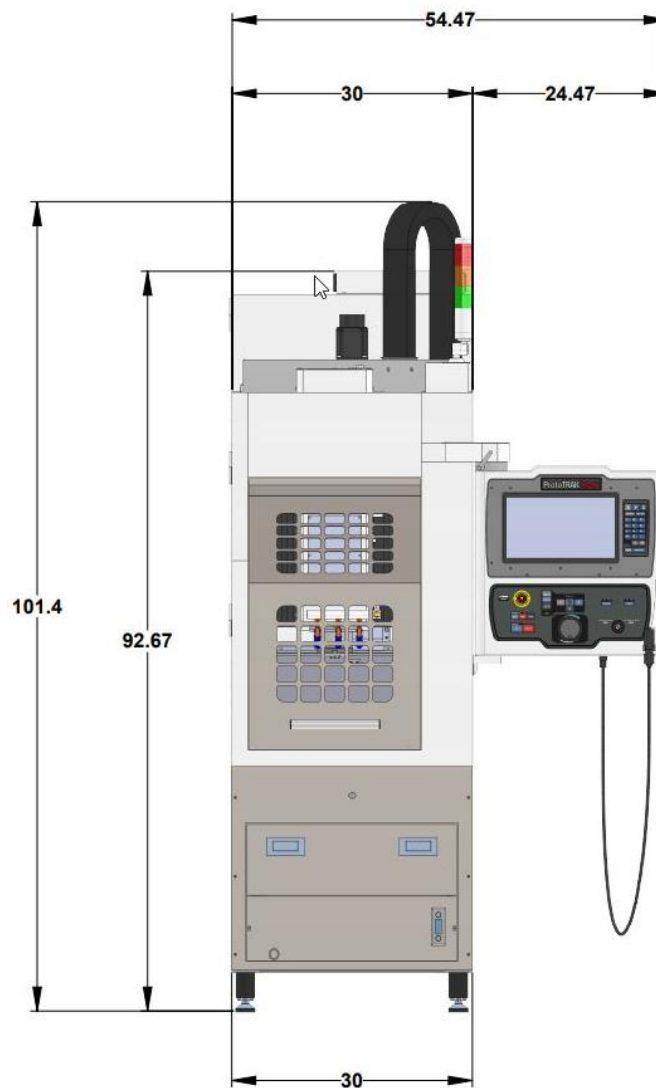

VMC2 Front View

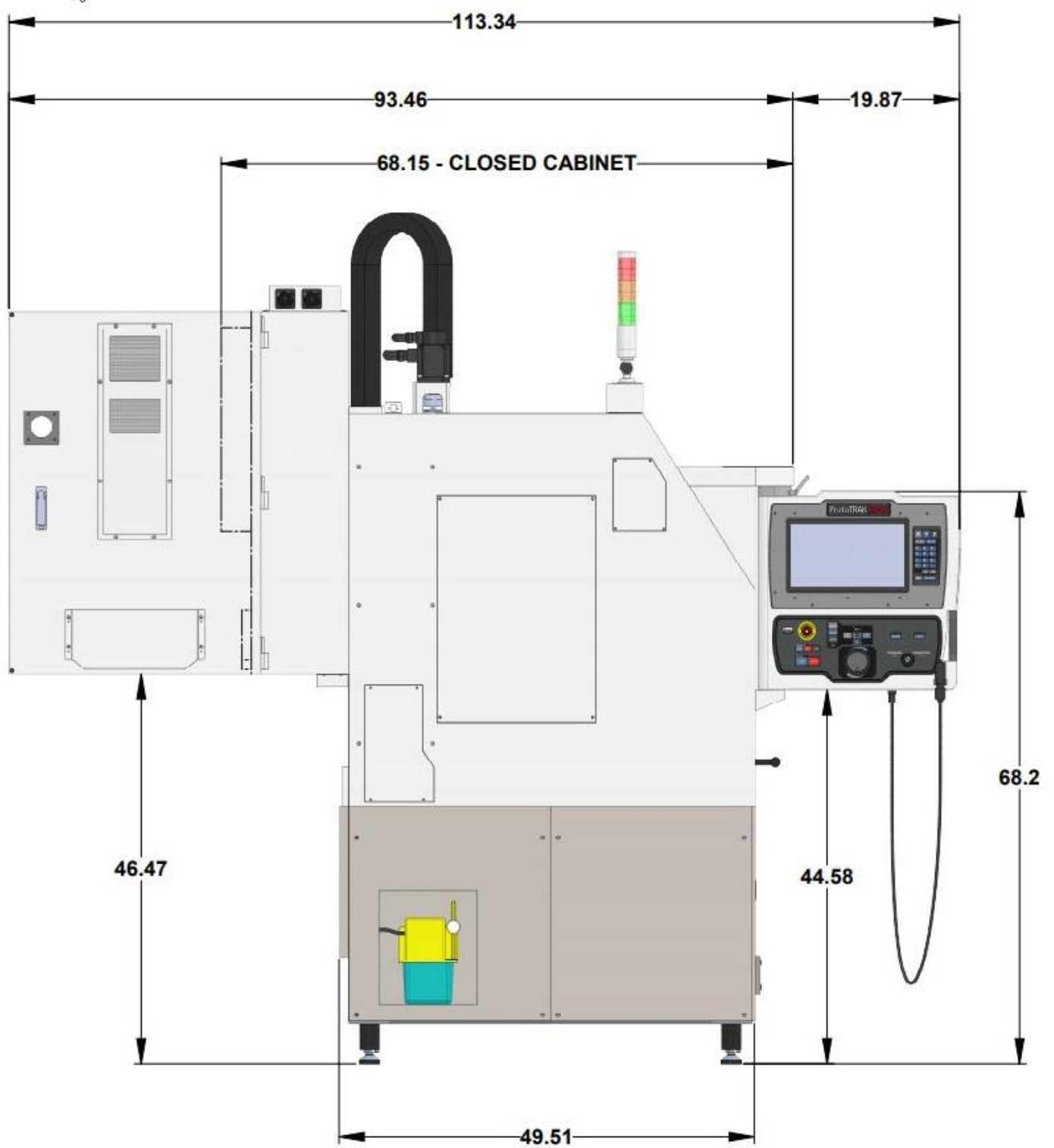

VMC2 Left Side View

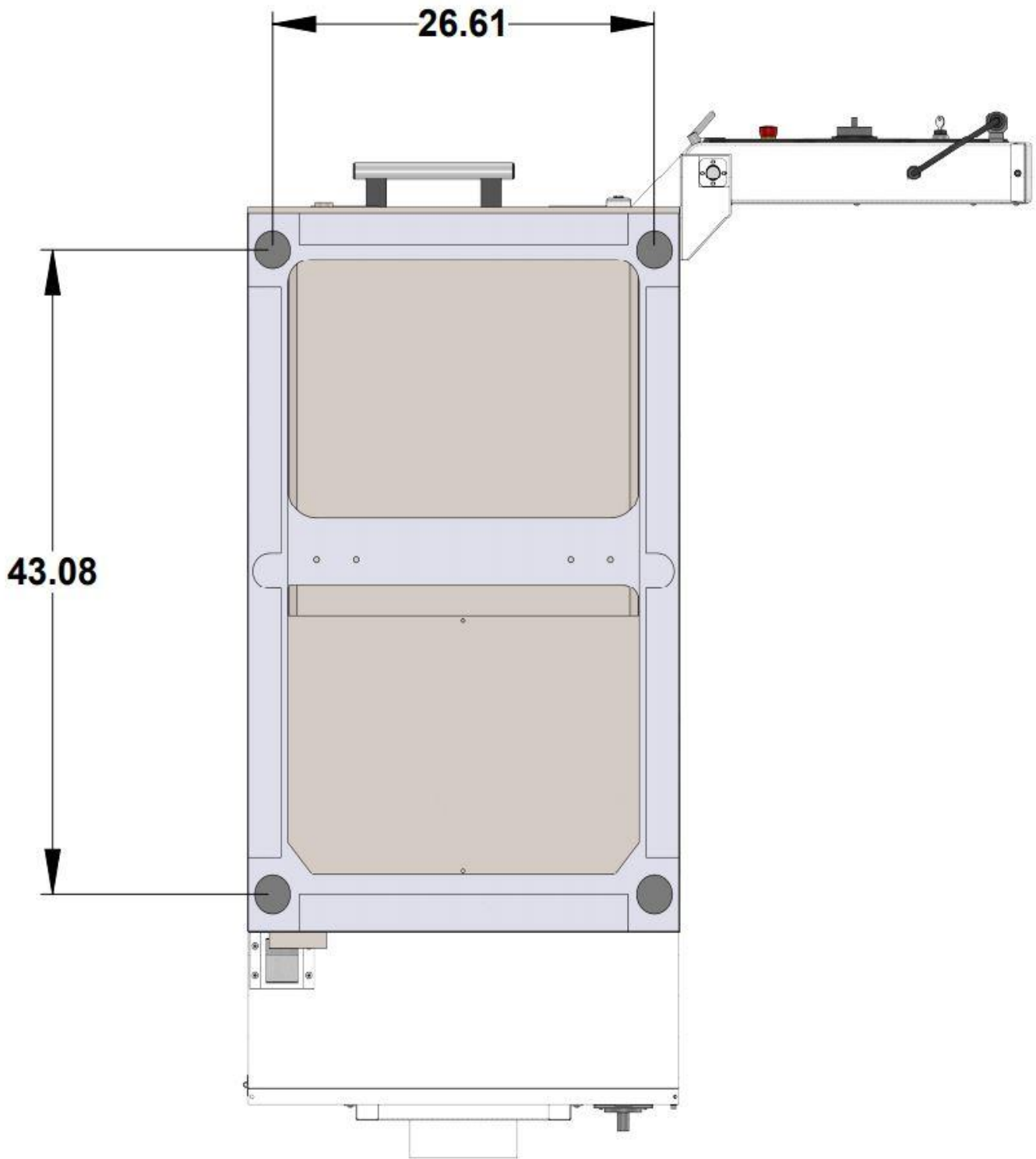

VMC2 Bottom View

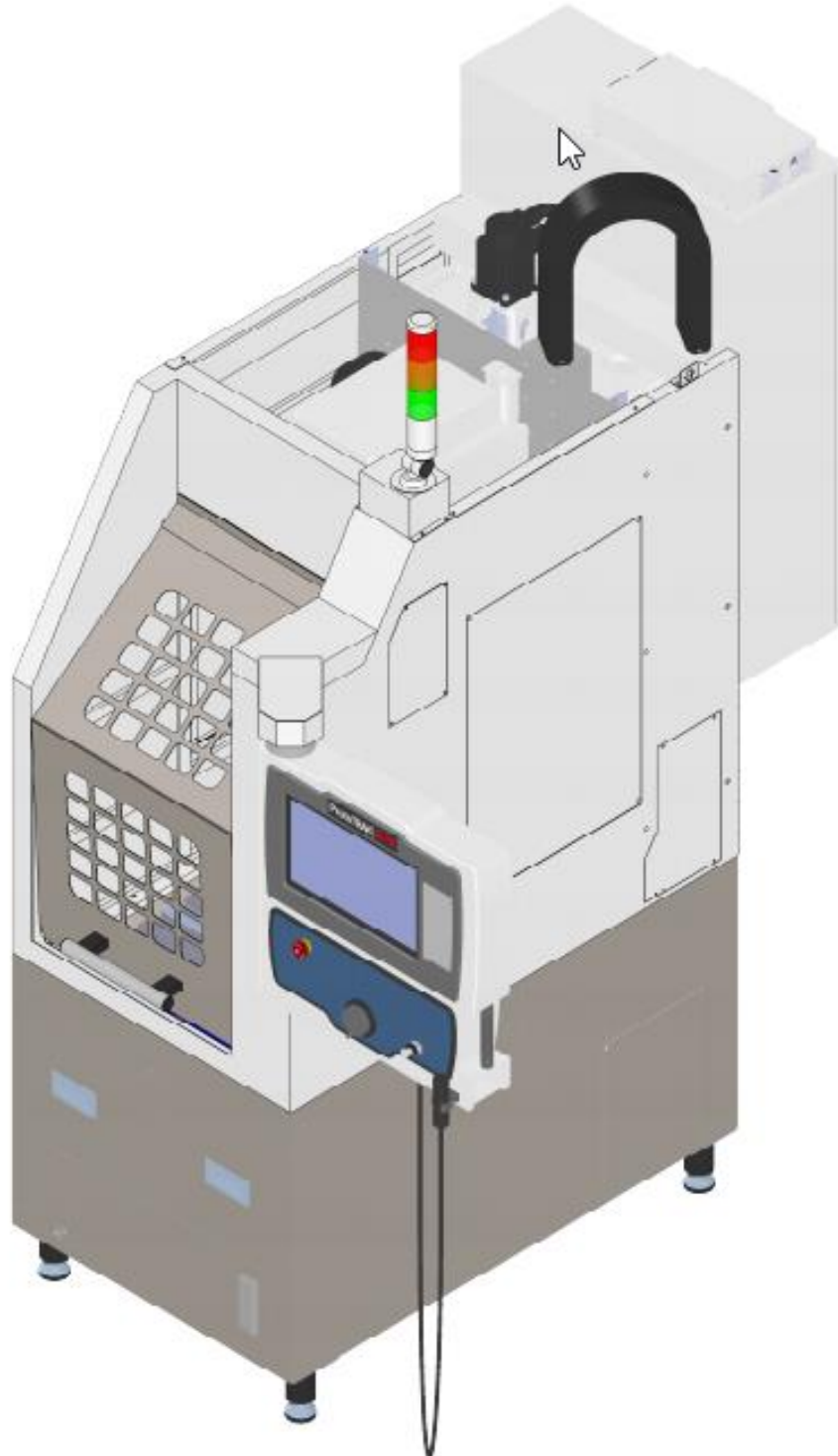

VMC2 Isometric View

2.3 Cleaning the VMC2

1. Remove all the cardboard and protective plastic sheeting from the machine.
2. With a soft cloth, remove all the protective oil from the machine. **DO NOT USE ANY SHARP OBJECTS ON THE LINEAR GUIDEWAYS OR THE BALL SCREW. USE ONLY LINT FREE CLOTH IN THESE AREAS.** It may be necessary to move the table, saddle and head left and right, up and down when cleaning.
3. Clean the way covers as they come shipped with a rust prevention spray on them. WD-40 works well to remove this agent.
4. When cleaning the windows, use a suitable cleaner that **DOES NOT** contain ammonia or solvents that could damage the polycarbonate windows.

WARNING!

Do not use water-based cleaning agents for cleaning the machine.

ATTENTION!

Immediately report, in writing, any damages observed at this time that can be attributed to the transportation or improper handling/moving of the machine.

2.4 Lifting and/or Placing the VMC2

CAUTION!

Risk of Injury or Mill Damage

Lifting devices with narrow forks must be used to lift the VMC2. Standard pallet jacks with approximately 27" forks will not lift the mill safely from the front or rear and not align with lift points on either side of the mill.

The VMC2 must be lifted and/or moved with a forklift with a minimum capacity of 5,000 lbs with the forks extended all the way through the mill.

Fork Lifts and Pallet Jacks:

Forks from a pallet jack or a fork lift must go all the way thru the mill to support each side as shown in figure 2.4a. Lifting from either side requires alignment with the lift point as labeled on the mill. It is not recommended to pick up the VMC2 from the rear because of the extended electrical cabinet.



Figure 2.4a - Detail of Lift Blades Set Under VMC2 with Proper Lift Points

Note - These lift points are critical to use because of center of gravity of the spindle column.

Optional equipment with the VMC2 is a narrow pallet jack with forks about 20" apart which can be used on all four sides. Make sure the forks extend all the way through the machine if lifted from the front or side as shown in Figure 2.4a and 2.4b.



Figure 2.4b - Front Lift with 5,500 Capacity Pallet Jack

IMPORTANT

Before lowering the machine make certain that the 4 leveling feet have been re-attached to the machine. Lubricate the threads on the feet before installing. Remove the shipping brackets and add the leveling feet. Thread in the leveling feet until the machine sits about 5 1/2" above the ground.

2.5 Uncrating the VMC2

1. Remove the loose articles from the pallet and check them against the loose Inventory Checklist (Section 2.7).
2. Remove the red brackets (one on each side) that hold the bridge casting (X axis) to the column. Remove side panels to gain access. Brackets are held on with (2) M8 and (2) M6 SHCS. See figure 2.5b.
3. In the chip tray below the front door, locate the status light and white sheet metal side covers. Install the side covers where the red shipping brackets were mounted (screws are included with the brackets).
4. Install the Status Light in the upper front corner of the VMC2. Remove the small side access cover to connect the light.

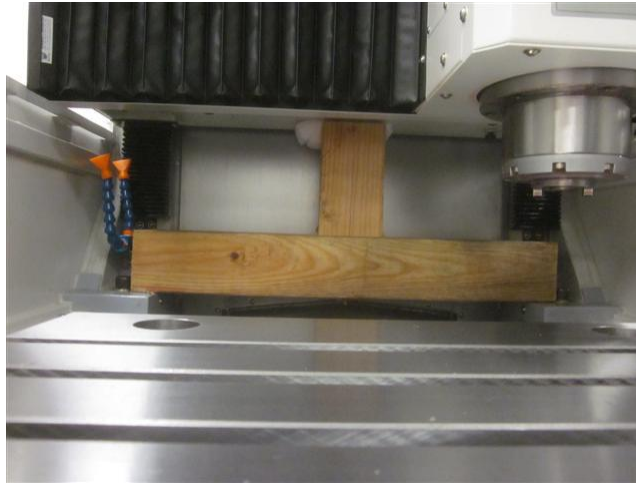

Figure 2.5a - Wood X-Axis Support Block

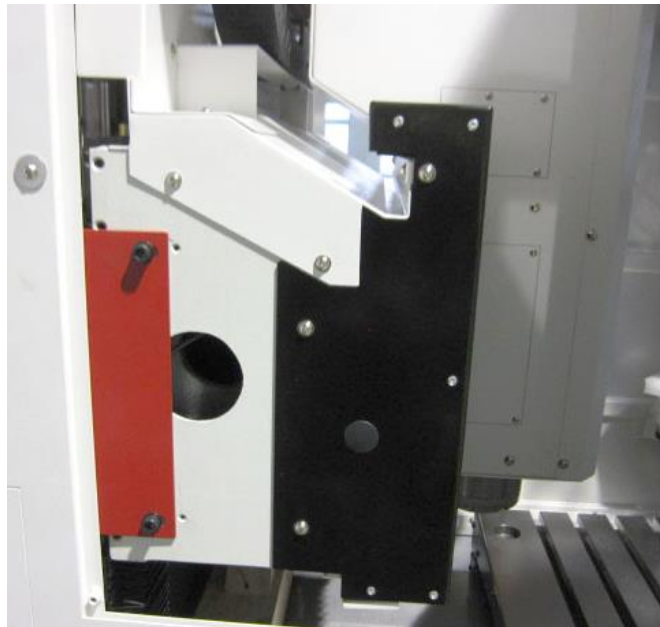

Figure 2.5b - Detail of Bridge Casting (X-Axis)

2.6 Leveling Procedure

1. Thoroughly clean off any oil or protective coating on the work table, using WD40 and a clean rag.
Note - Machine needs to be powered up.
2. Using service code 505, jog the Z axis up to allow removing the "T" shaped wood support block for the ability to jog axes.
3. Jog the work table 3 inches forward of the ATC door.
4. Place (2) spirit levels on the table. Place one left to right centered on the rear side of the work table near the T-slot. Place the second level front to rear centered near the first level ¼" from the rear T-slot.
5. Adjust the leveling feet so the bubble in both levels is centered.
Note - The machine's rear is heavy and the leveling feet will feel tighter on the rear side. Try to obtain equal pressure on the front feet and the rear feet respectively. All leveling feet must contact the floor.

Modifying Level for Tram

1. Mount a mag base and .0001" test indicator to the spindle nose and sweep the table with a 12" span (6" radius).
2. The Tram specification is .001" TIR. Adjust the leveling feet to obtain this value.
3. Once complete, lock all leveling screws in place with the lock nuts. Make sure all 4 leveling feet are touching the floor.

2.7 Shortages: Inventory Checklist

ATTENTION!

Immediately report, in writing, any damages observed at this time that can be attributed to the transportation or improper handling/moving of the machine.

The following items will come with the VMC2 mill. Please note if the optional items that have been ordered are present:

"T" Shaped Wood Block and Brackets Fastened to Machine – Must be Removed Before Use

- (1) Head Shipping Bracket shown in figure 2.5.a
- (2) Side Brackets shown in figure 2.5b

Loose Accessories Checklist

- (4) leveling feet – Wrapped and shipped uninstalled. Lubricate the threads before installing the leveling feet. Set height at approximately 5 ½" from the floor to the bottom of the machine.
- 31552 – VMC2 Service and Maintenance Manual
- 31550 – VMC Series 2/5/7/10 Programming and Operating Manual

Potential Optional Items:

1. Fixture Plate
2. Vise Fixture Plate Kit – Includes aluminum fixture plate, fence and vise stop assembly.
3. Vise Stop Assembly
4. Retention Knobs – A kit of 8 knobs.
5. Primary Liner Kit – Comes with 8 liners.
6. Secondary Liner Kit – Comes with 8 liners.
7. Ball Lock Clamping Kit – Comes with 4 clamping shanks.
8. 6" Kurt Vise
9. USB Memory
10. BT30 Tooling Kit
11. Tooling Cart
12. Indexer Ready Kit – Used in conjunction with a Hardinge indexer purchased through them.
13. Pallet Jack

2.8 Electrical Connection

The VMC2 comes with a 208 or 480-volt power cord/plug so the machine can be easily moved around the shop. The female connector that needs to be provided by the end user should match the connector that we provide. Figure 2.8 is a picture of the plugs we provide. From left to right they are as follows: 208-volt 3 phase 30-amp plug, 480-volt 3 phase 20-amp plug and single phase 208 volt 30-amp plug.



Figure 2.8 - Provided Electrical Plug Options

The user must provide a power circuit that provides 3 phase 208 voltage 30-amp capacity (208 – 240 V acceptable) or 3 phase 480 voltage 20-amp capacity (440 to 520 V acceptable).

2.8.1 Transformer Option

The VMC2 mill must be ordered for 200 to 240 or 440 to 520 volts. The transformer option is available for purchase if a 480-voltage operation is needed. A transformer outputs 220 volts. During the installation of the machine, the wires to the transformer may need to be moved based on input. At the factory the wires on the transformer are placed on the 480-volt input tap.

WARNING!

The input voltage to the machine should not exceed 520 volts. The spindle inverter is not rated for voltages higher than this. If the shop has voltages that exceed these numbers, they will need a step-down transformer to lower the voltage. Voltages higher than this may void your warranty.

DANGER!

You must turn the power off to the machine before adjusting the wires on the transformer. Failure to do so may cause death by electrocution.

Figure 2.8.1a shows the terminal blocks for a 480-volt machine where you can switch the wiring. For example, the machine is most likely shipped from the factory with the wire in the 480-volt terminal. This wire needs to be moved to the 440 or 520 terminal if the input voltage to the machine measures this amount.



Figure 2.8.1 - Transformer Used on 480 Volt Machines

2.8.2 Single Phase Power Option

The VMC2 mill has an optional single-phase option for 208-volts. It needs to be noted that running the machine on single phase power reduces the spindle power by about 40% as compared to 3 phase 208-volt power. In other words, the spindle will not produce 3 HP. A different style electric cord plug is used with single phase power. As part of the single-phase kit, we will provide an adaptor cable that allows the user to plug the machine into a 3 phase 208-volt power connector. Please note that the machine will still only run on single-phase power with this adaptor. In order to convert the machine back to 3 phase power, a number of changes need to be done to the machine. See figure 2.8 for an illustration of single phase 208-volt 30 amp plug which is the one at the far right of the photo.

2.9 Connection

2.9.1 Air Regulator/Air Pressure Switch/Solenoid Assembly Mounting

The Rear Air Panel ships uninstalled with the machine. Install and connect the electrical and air lines.

Electric and air lines are bundled and stored in the lower rear compartment. Pictures below identify the individual connections stored in the rear compartment that need to be made on the rear air panel.

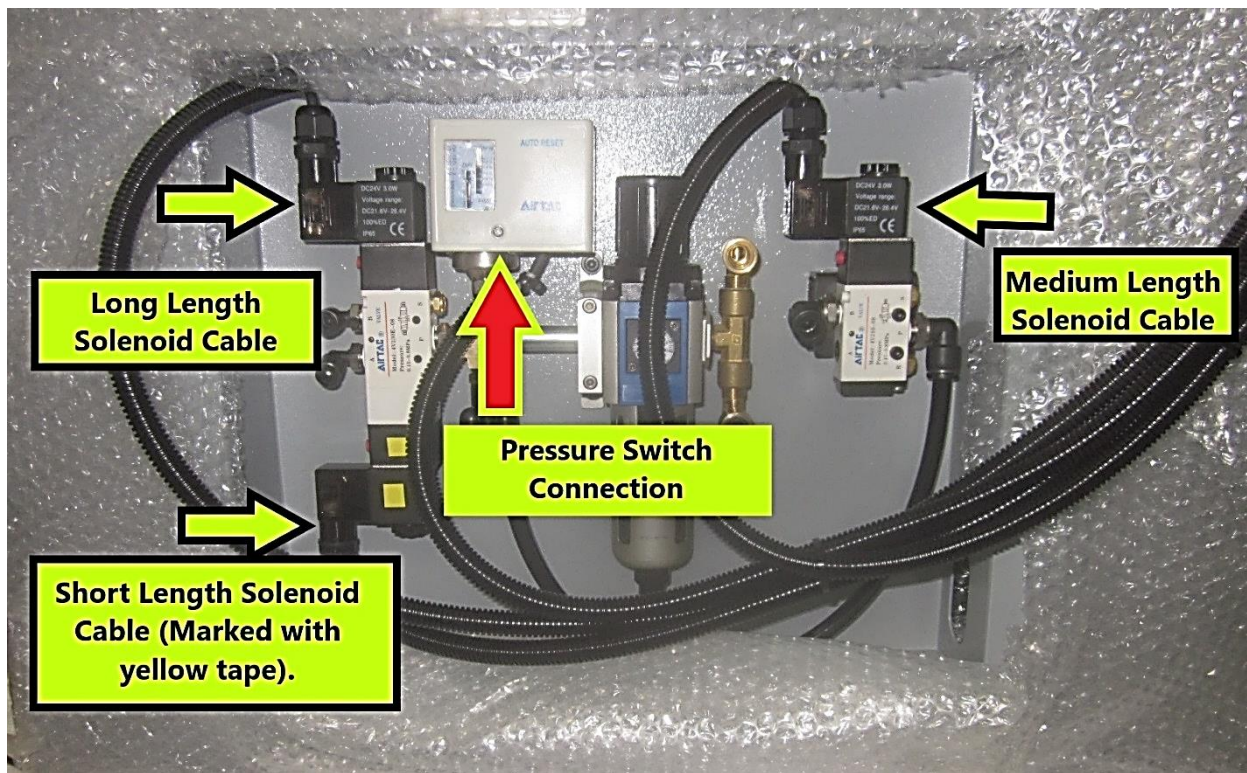

Figure 2.9.1a – Rear Air Panel Electrical Connections

Attach the solenoid cables as shown. The cable with yellow / orange tape connects to the lower portion of the main solenoid on the LH side of the panel. The long length cable attaches to the upper portion of the main solenoid. The medium length cable connects to the “air blast” solenoid on the RH side of the panel. See figure 2.9.1a.

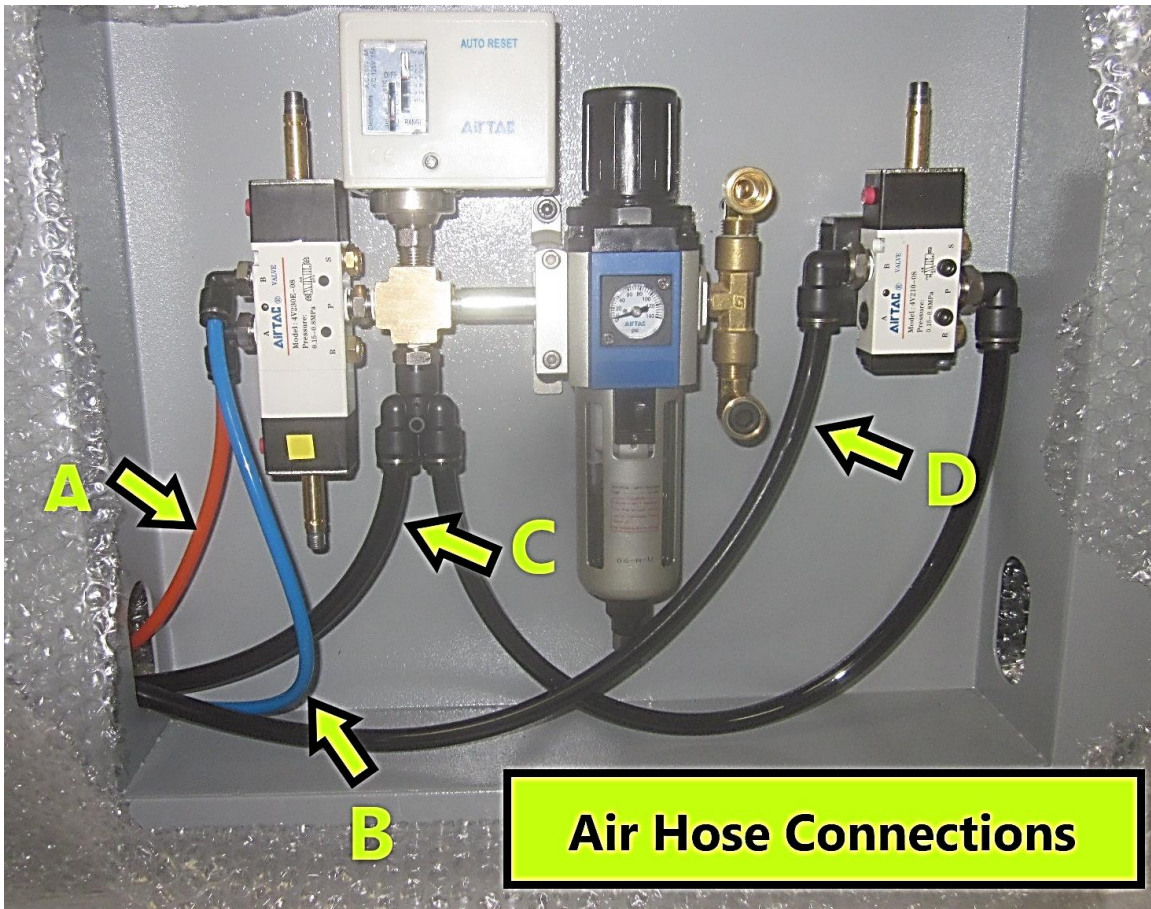

Figure 2.9.1b - Air Hose Connections

Air hose "A" and "B" connect from the left side to the main solenoid as shown. The orange hose connects to location "A" and the blue hose to location "B." (**Note** - *Be sure these are correct as problems with the ATC will occur if incorrectly installed.*) There are (2) two larger (10mm) black hoses to connect. The hose leading from a "T" fitting connects to location "C," a "Y" fitting connects below the pressure switch. Hose labeled "D" connects to the air blast solenoid, on the right-hand side of the panel. See figure 2.9.1.b

2.9.1.1 Pressure Switch Connection

Remove the cover and install the loose wires IDC24-30C6 and 24VDC as shown in figure 2.9.1.1. Push the wire and shielding into the switch, using a zip tie to hold the wire and shielding inside the switch and prevent them from slipping out.

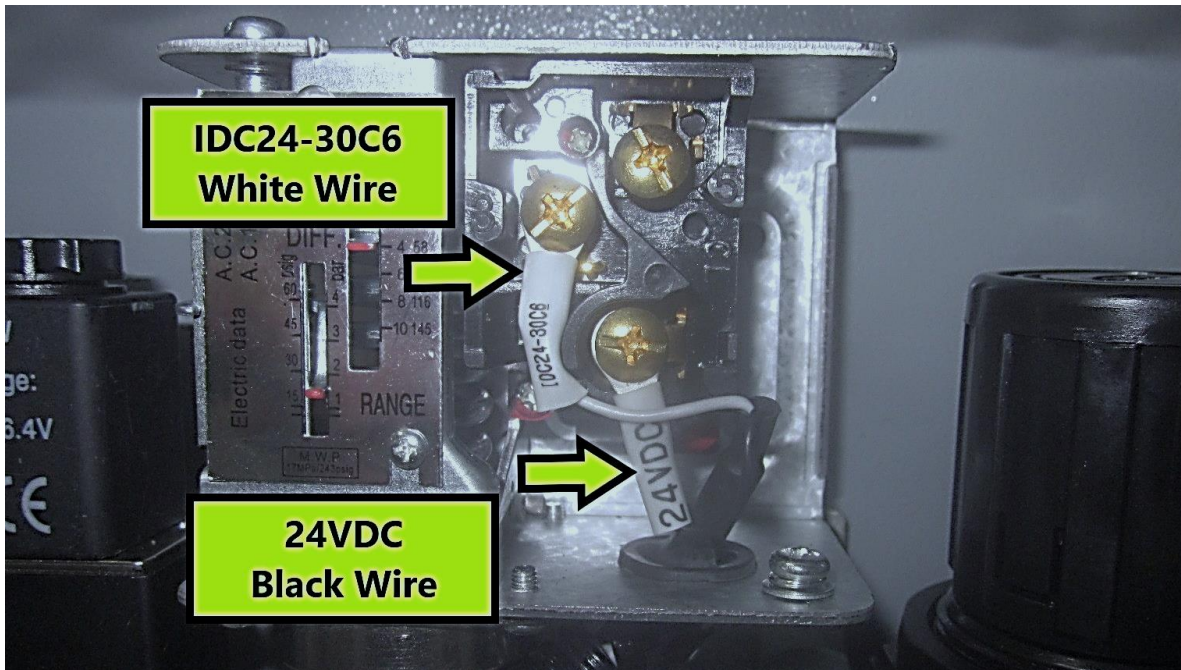

Figure 2.9.1.1 - Air Pressure Switch Electrical Connections

2.9.2 Air Connection

Connect the air supply to the quick disconnect coupling to the left of the pressure regulator. The air supply line should have a minimum of 3/8" inside diameter. It is recommended that a water separator or air dryer be installed upstream of the VMC2 air supply. See the pneumatic drawing 27563-1 for where the air is connected to the machine and all other pneumatic information.

2.9.3 Air Regulators and Solenoids

The VMC2 consists of a main air regulator, air pressure switch, door pressure regulator, spindle air regulator, multiple air flow valves, 2 solenoid valves, check valve and an exhaust valve. They are all set at the factory but should be checked upon installation.

The main air regulator for the machine should be set at 90 psi. The regulator is adjusted by pulling the cap upward and rotating the cap clockwise to increase the air pressure and CCW to decrease the air pressure. The air regulator/filter will filter out debris and some water or oil. Once the regulator is filled with up to a point with water or oil, it will automatically drain this water or oil out through the black cap found at the bottom of the assembly.

2.10 Installation Checklist

Installer – Use this checklist to assure a complete setup on the VMC2.

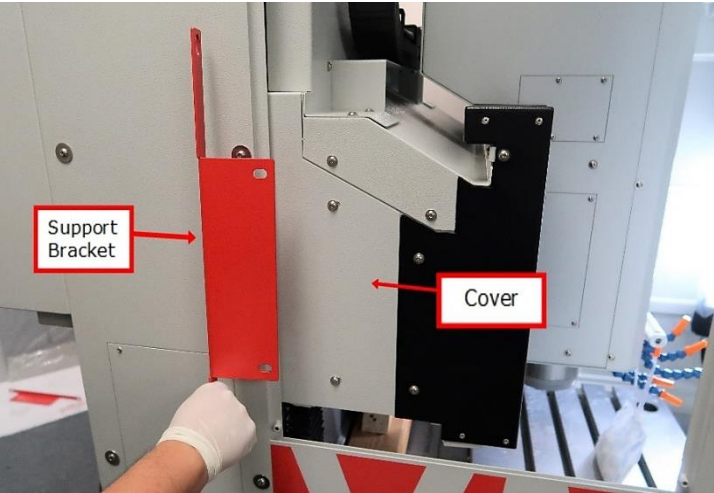
Installation Checklist	
<input type="checkbox"/>	1. Attach rear air panel for the air regulator, pressure sensor, ATC solenoids and make all connections. See section 2.9.
<input type="checkbox"/>	2. Visually inspect the 208-volt cable (or 480-volt cable if option is installed) going into the electrical panel. Visually verify the wiring is correct per our wiring diagram and the voltage is between 208 and 240 volts or 440 and 520 volts. Have the customer resolve any voltage discrepancies coming into the machine. Do not turn on machine if voltage is outside of ranges listed above.
<input type="checkbox"/>	3. Clean the machine if needed and remove any remaining protective grease or oil.
<input type="checkbox"/>	4. Remove the 2 red side brackets that support the X axis bridge to the column and install the small white side covers (found in the chip tray) in place. Replace both side panels. Refer to section 2.5. <div style="text-align: center; margin-top: 10px;">  </div>
<input type="checkbox"/>	5. Remove the plug on the network port (if being used). The networking plug is found on a sheet metal bracket located on the upper right rear side of the machine.
<input type="checkbox"/>	6. Turn on the power to the machine.
<input type="checkbox"/>	7. Press and hold the servo on button to make sure the axis motors are activated. The screen should change from saying SERVO OFF to SERVO ON. The lube pump should also cycle 1 time when the SERVO ON button is pressed. You can use service code 300 to manually lubricate the machine.
<input type="checkbox"/>	8. Check that the air pressure on the air regulator is set to 90 psi
<input type="checkbox"/>	9. Go to Service Code 505 and raise the Z axis to remove the wood "T" shaped support block. Jog the X and Y axis a bit to verify movement. Press SET HOME to home machine. Did the X axis home properly? Did the Y axis home properly? Did the Z axis home properly?
<input type="checkbox"/>	10. Level the machine first with spirit levels (see above text) and then adjust the tram.
<input type="checkbox"/>	11. In DRO mode, turn the spindle on and then turn the coolant pump on by pressing the Coolant button and confirm coolant is working. Press the Air button and confirm compressed air is working.
<input type="checkbox"/>	12. Select the X axis, does the spindle head move to the right when turning EHW CW? Select the Y axis, does the saddle move toward the operator when turning the EHW CW?

	Select the Z axis, does the head move up when turning the EHW CW? Check that 1 click of the EHW in 0.020" mode is in fact 0.020".
<input type="checkbox"/>	13. Double check the motor index angle for each axis using service code 505. If this needs to be modified, then the ATC tool change locations may need to be reset in services codes 520.
<input type="checkbox"/>	14. Final test each axis by jogging (turning EHW) at 0.020" speed into the soft limits. Verify the machine does not hit the hard stop on the machine. Re-adjust limit switch cam if it does. Service Code 520 may need to be performed if major adjustments have been made to the X and Y axis limit/home locations. Within service code 505 you can manual adjust the soft limit values in the table provided.
<input type="checkbox"/>	15. Check to make sure that the E-Stop button is functioning correctly. Turn spindle on and jog an axis using the EHW. Press the E-stop button during this operation and verify the spindle and axis stops. Make sure the Z axis does not move when the E-stop is pressed. The brake on the Z axis motor will hold the head.
<input type="checkbox"/>	16. Is the spindle motor fan running? Air should be blowing down over the spindle motor.
<input type="checkbox"/>	17. Close the door and make sure the control recognizes the door as being closed. When the door is open a DOOR OPEN message should be on the screen when in DRO mode. It goes away when the door is closed.
<input type="checkbox"/>	18. Verify the door opens and closes with a minimal amount of force and moves smoothly. We set the air regulator for the door to be between 70 and 75 psi (verify) which equates to roughly 8 to 10 lbs of force to lift the door. Make sure the door fully closes under its own weight. Make sure hardware that holds door rollers is tight.
<input type="checkbox"/>	19. Press the manual tool change button on the head (WHITE button) and make sure air is coming down through the spindle. This can be adjusted, see pneumatic system drawing 27563-3.
<input type="checkbox"/>	20. Put a tool in the spindle and verify the tool clamps once the white button is released.
<input type="checkbox"/>	21. Go to DRO mode and then Tool Table, and then ATC Front. The ATC should come forward. Remember the door must be shut. Press ATC Back, once it comes out and it should prompt you to press GO again to move it back.
<input type="checkbox"/>	22. Use CALL TOOL and RETURN TOOL in the tool table screen to load a tool in and out of the ATC.
<input type="checkbox"/>	23. Verify the ATC sensors that tell the control if the ATC is in or out are properly tightened. Remove the rear cover on the machine to check them.
<input type="checkbox"/>	24. Turn off air to the machine and verify the control recognizes low air pressure. There should be a flashing warning message in the DRO screen that says low air pressure.
<input type="checkbox"/>	25. Run spindle in DRO at low speeds.
<input type="checkbox"/>	26. Spindle head test Run spindle at 1000 RPM for 5 minutes Run spindle at 10000 RPM for 5 minutes. Make sure the spindle brakes properly from 10000 RPM. It should stop in 6 seconds or less. Run spindle at 500 RPM increments for a few seconds per increment. Please note any of the following: Head noise, excessive heat on spindle, vibration, spindle fan noise.
<input type="checkbox"/>	27. Write a simple program with multiple tools called out and run program to make sure everything runs properly, including changing tools in the ATC. Try to use actual tools when running this program. We also have a test program in the VMC2 inspection test programs folder called VMC2 ATC TEST PROGRAM.PT10

28. Make sure coolant wash down lines are adjusted properly. See picture below showing how they should be adjusted. One line should be directed toward the rear door and one toward the rear of the table to wash chips away so they do not interfere with the ATC.

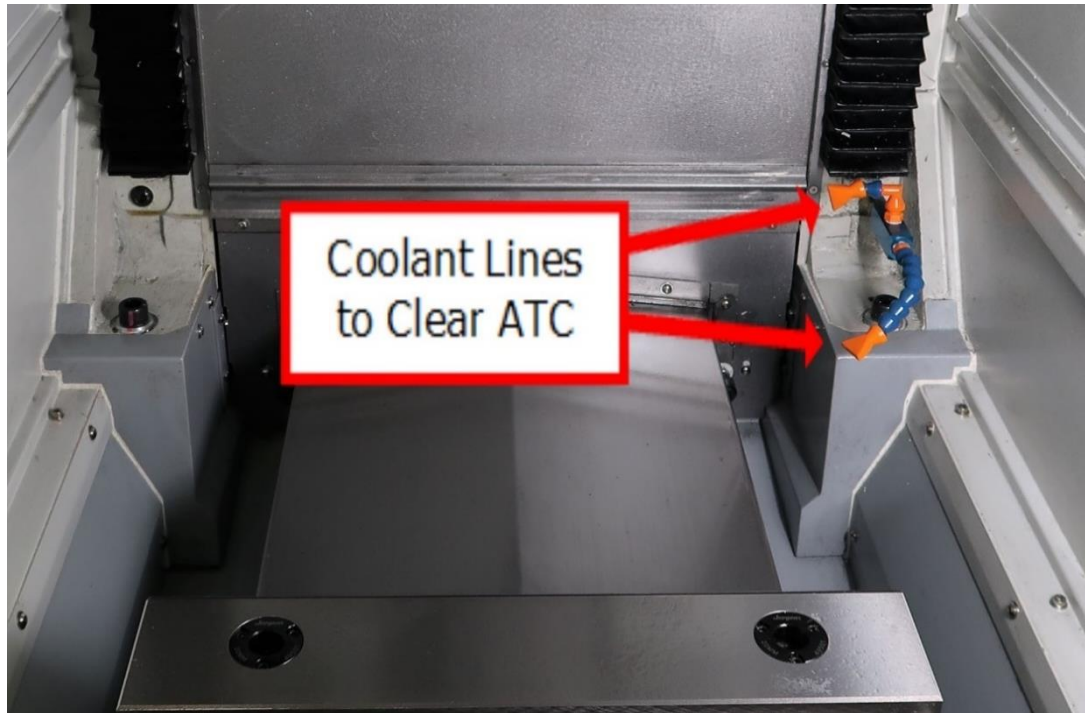

29. Make sure fine chip filter is installed on top of coolant tank.

30. Wipe the machine down before leaving.

2.11 Coolant and Coolant Wash System

The coolant and coolant wash system uses 1 pump to provide coolant to the work area and also helps to clear access for the ATC when it cycles for tool changes. Target area for the Wash System can be controlled by the flexible coolant lines found near the spindle.

The coolant tank holds approximately 15 gallons of coolant. Coolant Wash can be controlled by the operator in two ways. There is a button on the Run Panel that allows the Coolant Wash to be turned on and off by the operator at will. The second method to provide coolant is accessed from the Programming Panel, select PROG and your Event. There is a slide switch which enables automatic coolant wash when the coolant button on the Run Panel is set to auto. See figure 2.11.

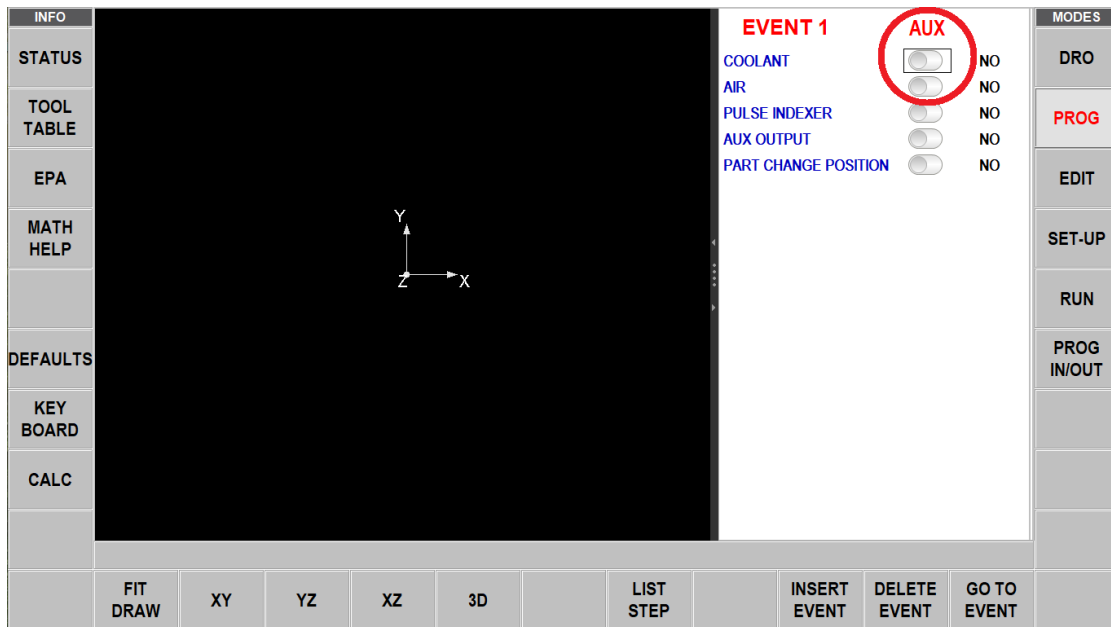

Figure 2.11 - Coolant Wash and Air Blast Switches

2.12 Air Blast System

The air blast system uses shop compressed air to provide a method to clear chips and coolant as needed from the work area. In addition, air blasts help to clear access for the ATC when it cycles for tool changes. Air blasts can be redirected simply by moving their flexible hoses near the spindle.

Air Blasts can be controlled by the operator in two ways. There is a button on the Run Panel that allows the Air Blast to be turned on and off by the operator at will. The second method to provide air is accessed from the Programming Panel, select PROG and your Event. There is a slide switch which enables automatic air blasts when the air blast button on the Run Panel is set to auto. See figure 2.11.

2.13 Lubrication

2.13.1 Way Lubrication

The auto lube system is located on the left side of the machine and provides centralized automatic lubrication for the linear guides and ballscrews. The lube pump's 1-liter reservoir is serviced with ISO AW32 lubricating oil. The lube pump cycles automatically 1 time upon initial startup after pressing the POWER RESET button of the control and then 1 cycle for every 30 minutes of axis movement time. Each cycle of the lube pump lasts for 4 seconds or so and provides oil to the linear guides and ballscrews.

Discharge Pressure - Approximately 140 psi

To adjust the amount of Discharge Pressure displayed on the lube pump gauge, turn the adjustment screw clockwise to increase the pressure. 1 turn of this screw will raise the pressure about 100 psi. At the beginning of each day, check the oil level in the auto lube system. See figure 2.13.1.

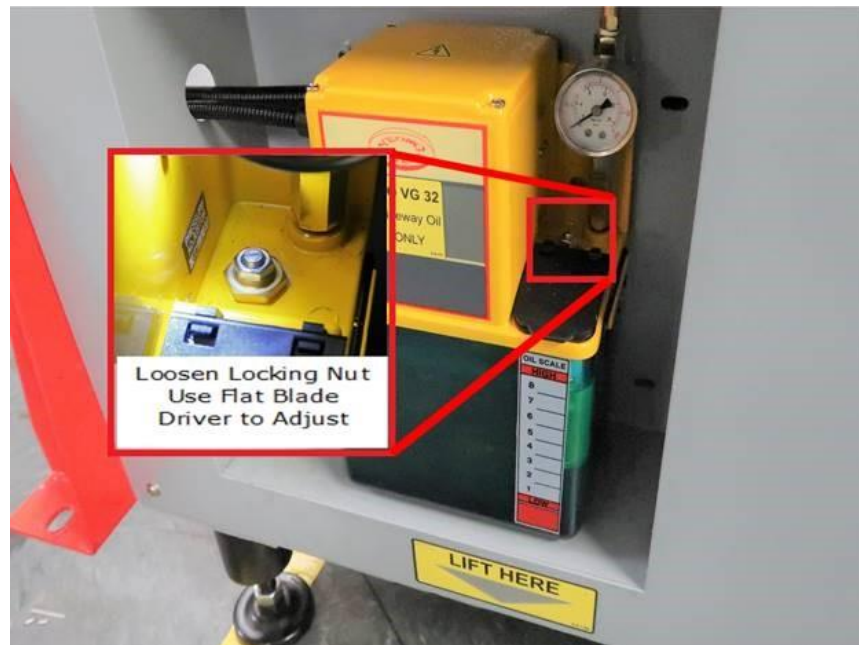

Figure 2.13.1 – Lube Pump System

While the system is automatic, it is recommended that after long idle periods, the machine be manually lubricated by using Service Code 300. Repeat this process 2 or 3 times. The lubrication reservoir should be maintained on a daily basis, filling with ISO AW32 lubricating oil. See *Lube Pump Setup Service Code* section.

CAUTION!

Failure to manually activate the pump at the beginning of each day if the control was left on and the machine has been idle for a long period of time may cause severe damage to the linear guides and ballscrews.

2.13.2 Other VMC2 Lubrication Points

1. Tool Change Air Cylinder Oil Cup supplies oil to the "Air Over Oil" cylinder and should not require replenishment. If it does, there is likely a leak in the system. However, if required, fill the oil cup on the front of this cylinder with an ISO AW32 oil or equivalent.
2. **Grease Fittings on ATC**
Apply a good grade of general purpose lithium based grease (#1.5 or 2) such as Shell Gadus S5 V460 1.5 or equivalent through the grease fittings found at the rear of the machine that supply grease to the ATC linear guide blocks. The manufacturer of the linear guide blocks recommends 1 cm³ of grease every 100 kilometers of travel. This equates to ~ 100000 tool changes. The frequency of adding grease should be based on how many tools changes you make per day. See figure 2.13.2.

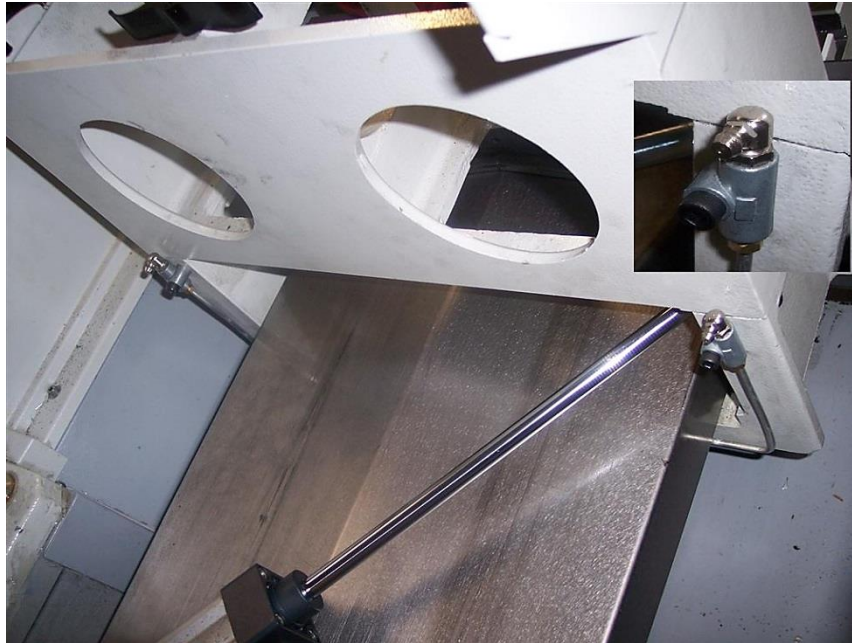

Figure 2.13.2 - ATC Linear Guide Blocks Lube

2.14 TRAK VMC2 Machine Specifications

Overall Machine Dimensions

Width of machine	30" (Folded Pendant) 55" (Open Pendant)
Depth of machine	68.15"
Height of mill with head all the way up	101.5"
Minimum height to fit mill through doorway <i>(Z cable carrier collapsed, resistor cover and resistors removed)</i>	93"

Machine Specifications

Table Dimensions

Table size	18" x 15"
Number of tee slots and pitch	4 @ 63 mm
Tee slot width	0.630" or 16 mm
Table Maximum Load	500 lbs.
Ball Lock ® Hold Down Force	2250 lbs @ 35 in/lbs of torque
Machine Weight	~2825 lbs
Machine Shipping Weight	~3175 lbs

Travel

X-axis	14"
Y-axis	12"
Z-axis	17"
Maximum distance from spindle nose table surface	20.25"
Minimum distance from spindle nose table surface	2.75"
Maximum swing clearance from spindle center to column	14"
Maximum Rapid speed X, Y & Z-axis, inches per minute	600 Production OPS 400 Toolroom OPS

Spindle

Tool holder type	BT30
Spindle nose diameter	2.2" or 56 mm
Maximum RPM	10000

Automatic Tool Carrier

Tool Capacity	8
Maximum Tool Diameter	2" or ~50 mm
Longest Tool that can be used in ATC <i>(length measured from bottom of drive dog flange on holder)</i>	6.75"

Air Requirements

Pressure	90 psi
Quality	Air dried/filtered water separator upstream of the machine.
CFM	2.5 @ 90 psi
SCFM	18

2.15 Maximum Spindle Torque & HP

The following graphs illustrate the continuous and peak torque vs RPM (figure 2.15a) and horsepower vs RPM (figure 2.15b) for the VMC2 machine at the spindle. Peak torque and horsepower values can only be attained for a short period of time before the spindle drive will fault out to protect the motor.

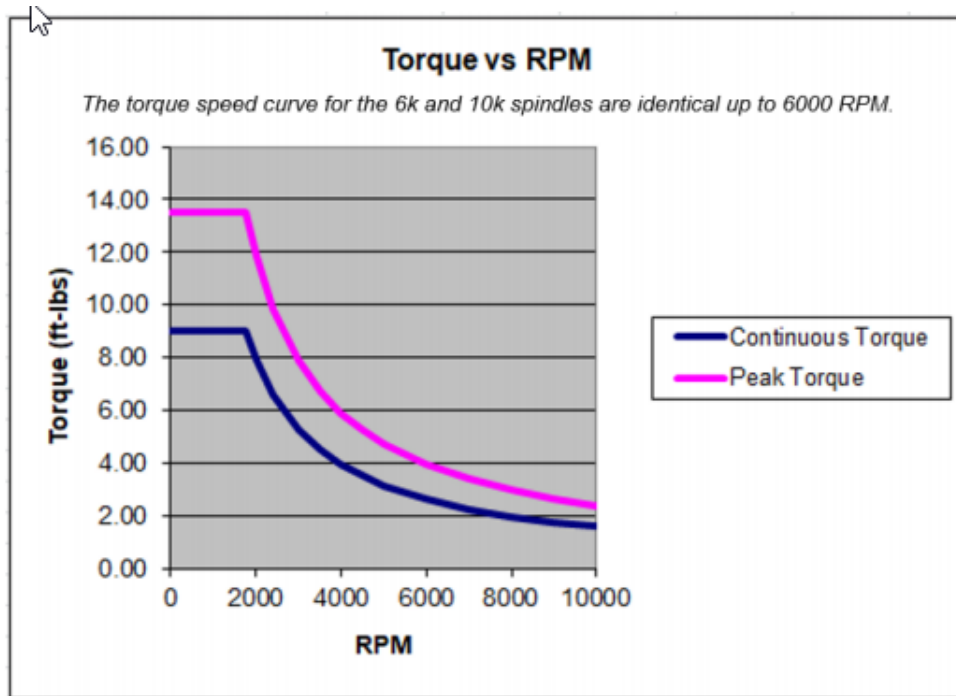

Figure 2.15a

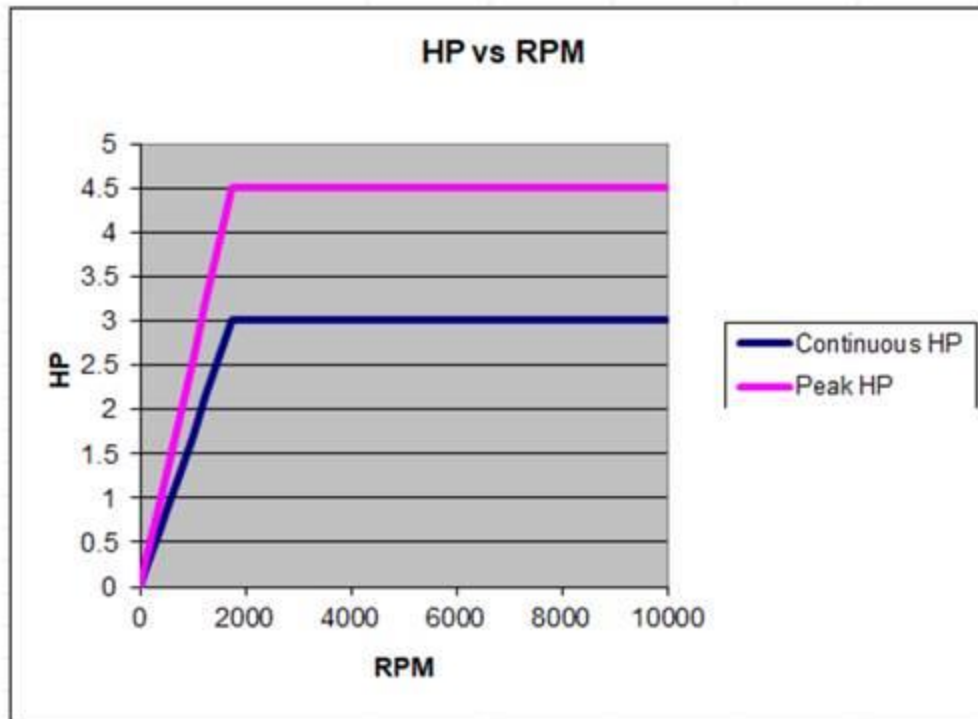

Figure 2.15b

Note - Maximum work capacities are dependent on a lot of variables that cannot be controlled by the machine manufacturer. Each one of the following will have an impact on the above numbers: speeds, feeds, cutter, cutter sharpness, material, setup, coolant and machine adjustments.

2.16 ProtoTRAK RMX Euclid Block Procedure

The test part should be machined at the completion of the installation.

The material for the Euclid block test part is found in the toolbox.

- Material Specification: Aluminum, 6061-T6 or T4
 - Blank Size: (minimum dimensions) 3 x 3 x 1", provided in tool box
 - Tool: Sharp ½" end mill, 2 flute, high speed steel, **sharp**
 - Coolant: Flood coolant
1. Mount vise and indicate the back jaw parallel to the table within .0005". Use fixture vise plate if customer ordered this option.
 2. Clamp material in vice with a minimum of .800" above the vise jaws.
 3. Load in the Euclid block program. It is found under the C drive, PROTOTRAK folder, and VMC2 INSPECTION PROGRAMS folder, click on EUCLID.VMC2.PT10 to run and follow instructions.
 4. Use an edge finder to set your offsets for X, Y and Z. Absolute zero is the front left corner of the block as viewed from in front of the machine.
 5. Load the .500" end mill and set Z Absolute 0 at the top of the part, and set Z total length offset in the tool table.
 6. Press the AUX button to turn the coolant on if you are going to use flood coolant.

7. Begin to run the program. The part will be machined in the following sequence:

Description	Depth of Cut
circle pocket – cuts middle circle	-0.250"
circle frame – cuts outer 1.830 diameter circle	-0.250"
circle frame – cuts material from corners remaining on Euclid block	-0.250"
roughs material in upper right-hand corner	
cuts triangle on Euclid block	-0.500"
rectangular frame – cuts outer 2.750" rectangle	-0.500"
position to 1.318 on X and Y	-0.750"
	+10.000"

8. After the program runs, the program will locate to the following position.

- a. X = 1.318
- b. Y = 1.318

9. Mount a dial indicator in the quill and check the circles using figure 2.16 as a reference.

10. Check the runout of the sides of the square frame.

11. Inspect the machined surfaces for smoothness.

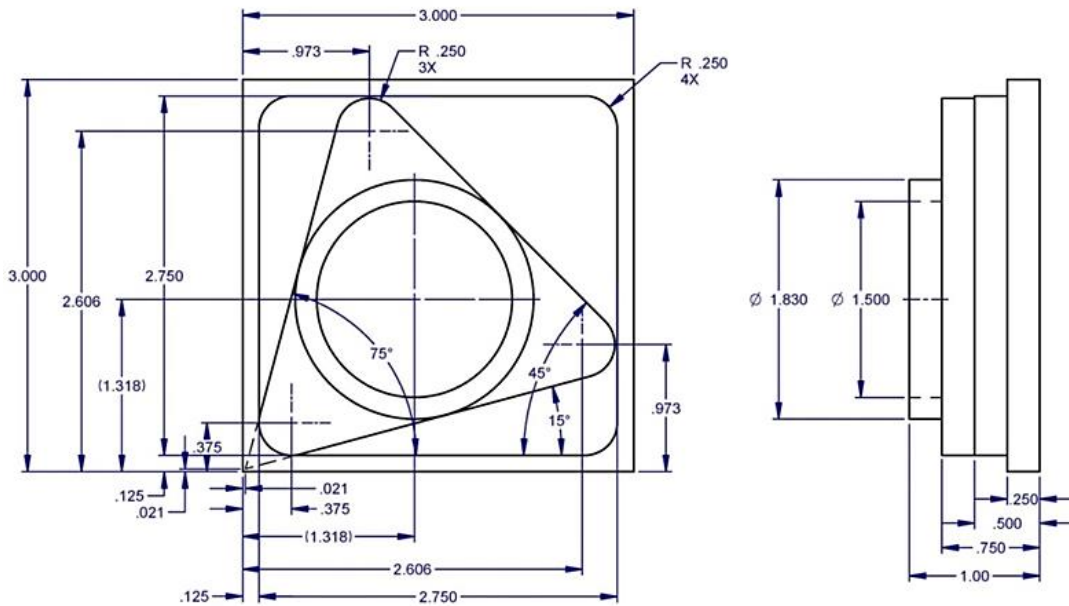

Figure 2.16

i15537-1

3.0 Troubleshooting by Symptom

Use this section to begin the process of resolving a service problem. Each symptom type is described in a few words and then more fully described in an explanatory paragraph. Following this is a chart that directs in the most logical steps.

FOR ADDITIONAL DETAILED TROUBLESHOOTING PROCEDURES, PLEASE VISIT OUR DOZUKI WEBSITE:
<https://trakmtsupport.dozuki.com/>

3.1 Problems Relating to Machining Results

3.1.1 Poor Finish

The part finish is marred with scallops or is very rough.

Do the following Service Codes and document values:

- **Code 33** - Software Identification. This is needed if you call SWI Customer Service
- **Code 128** - Enter backlash compensation
- **Code 134** - Friction Feed Forward

Possible Cause	Check This
Too much backlash entered for code 128.	Verify nothing is mechanically loose and the backlash values are not higher than what physically is in the system.
Friction feed forward set too high or low.	Check the value of code 134 and adjust as required.
Machine Tool & Setup Problem	Check for any looseness in the setup (Tool, Tool holder, Part, Vise, or Fixture). Check the condition and type of cutter being used, type of material, RPM and Feed rate, etc.
Inadequate or no lubrication to ballscrews and linear guide surfaces.	Make sure all the Linear Guide surfaces are getting proper lubrication. If not, check to make sure that the lube pump is functioning properly. Also check for any pinched or blocked oil lines.
X & Y-axis Drive Trains are loose	Check Repeatability using the Repeatability and Positional Accuracy procedure. Step by step, carefully inspect the Drive Train for any looseness. It may be necessary to disassemble and then reassemble the Drive Train.
Linear Guide surfaces are scarred, exhibit noise or vibration, or are excessively worn	Visually check the condition of all the Linear Guide surfaces. For machines that may have excessively worn Linear Guide surfaces, a trained SWI Technician may need to inspect this area to determine if they need to be replaced. Check lubrication to affected areas.

3.1.2 Circles Out of Round

Circles are not round within 0.001" TIR over a 1.830" dia. This is best measured by placing a dial indicator in the spindle and sweeping around circle on the Euclid block part.

Do the following Service Codes and document values:

- **Code 33** - Software Identification. This is needed if you call SWI Customer Service
- **Code 128** - Enter backlash compensation
- **Code 134** - Friction Feed Forward

Possible Cause	Check This
Backlash Values Set Too High or Low	Check code 128. Typically values for backlash should be less than 0.0005". Reset values as necessary.
Friction Feed Forward Set Too High or Low	Check the value of code 134 and adjust as required.
Machine Tool and Setup Problem	Check for any looseness in the setup (Tool, Tool holder, Part, Vise, or Fixture). See Machine Tool & Setup Section 5.1.
Machine Not Leveled	Verify that the machine is level to specification.
Head is Not Trammed	Verify that the Head is trammed to specification.
X & Y-axis Drive Trains are Loose	Check Repeatability using the Repeatability and Positional Accuracy procedure. Step by step, carefully inspect the Drive Train for any looseness. It may be necessary to disassemble and then reassemble the Drive Train.

3.1.3 Parts Have Incorrect Dimensions

Parts are being machined with dimensions that are different than those programmed. Typical accuracy expectations should be:

- **Circles:** 0.001" TIR over a 1.830" DIA (assumes cutting Euclid block)
- **Positional Accuracy:** 0.0005"
- **Repeatability:** 0.0005"

Do the following Service Code:

- **Code 33** Software Identification. This is needed if you call SWI Customer Service.
- **Code 123** Calibration
- **Code 128** Enter Backlash Compensation

3.1.3.1 Every Part Has the Same Error

Possible Cause	Check This
Machine Tool & Setup Problem	Check and verify correct tools & setup.
Programming Error	In the program, look for common errors in programming such as transposing numbers, tool diameters, and pressing INC SET when ABS SET is meant. This is especially suspected if the dimensional errors are larger than a few thousandths. See the Controls Programming, Operations and Care manual.
Configuration file that contains calibration file that has been erased or corrupted.	Make sure there are values for calibration under service code 123. Default values would read all zero's which means the machine needs to be calibrated. A back up copy of the configuration will be available at SWI. We will need the machines serial number when you call us.
Backlash Problem	Unusual high backlash values are causing slight variations in your part dimensions. Values for backlash should be less than 0.0005".

3.1.3.2 The Dimensional Errors Are Random or Accumulate in Size Over the Part Program Run

Possible Cause	Check This
X and Y-axis Drive Trains are Loose	Check Repeatability using the Repeatability and Positional Accuracy procedure. Step by step, carefully inspect the Drive Train for any looseness. It may be necessary to disassemble and then reassemble the Drive Train.

3.2 Motion Related Problems

3.2.1 Run Away Axis

The axis makes an unwanted move at rapid speed in one direction and faults out. This is usually caused by an encoder signal being interrupted or following error building up on that axis. Following error is when the control sends a signal to the motor and the motor does not respond as it should. Once the error builds up to a certain point this will lead to a following error fault.

Do the following Service Codes:

- **Code 33** - Software Identification. This is needed if you call SWI Customer Service
- **Code 131** - Turn the X or Y axis ballscrew manually to make sure the motor encoder counts. Each axis should count 6mm (0.236”) per revolution of motor. When using Code 131, first press the E stop, then go into this service code. It works only for X and Y axis.

Possible Cause	Check This
Poor Cable Connection	Check the cable connections at the motor, computer module and servo amp
Bad Servo Amp	Check the status of LED lights on servo amp when problem occurs.
Bad Motor Encoder	Contact TRAK to arrange service.
Computer Module	See section 6.1.5.4 to replace computer module.

3.2.2 Axis Will Not Jog with Electronic Handwheel

The system powers up but will not respond to the jog command using the electronic handwheel.

Do the following Service Codes and procedures:

- **Code 33** - Software Identification. This is needed if you call SWI Customer Service
- **Code 132** - Each revolution of the EHW should display 100 counts on the screen

Possible Cause	Check This
Software may be in an indeterminate state.	Press the MODE button and reenter the same screen and see if EHW works.
E-Stop is Pressed In	Check E-Stop. Make sure the servo ON button has been pressed to energize the servo system.
EHW has Failed	Verify the wiring of the EHW and replace as necessary. If only 1 axis will not jog, then it is not the EHW.
Poor Cable / Wiring Connections	
Servo Drive Failure	Contact TRAK for service.
Motor Failure	Contact TRAK for service.
Computer Module Failed	See section 6.1.5.4 to replace computer module.

3.2.3 Searching Axis

The DRO screen is flickering back and forth when the servos are engaged. Several ten thousandths of motion are observed and the frequency is one cycle every couple of seconds.

Do the following Service Code and procedures:

- **Code 128** - Backlash compensation

Possible Cause	Check This
Most often caused by excess backlash compensation.	Check physical backlash in system and re-enter in code 128.
Looseness or excessive friction in the drive train.	The drive train of the axis that is searching, especially the tightness of the drive assembly.

3.2.4 Homing Error – Axis, Tool Changer

The homing function is a very critical function that locates and identifies the absolute machine zero position, where all other positions and offset are derived from. This function is to be performed every time the system has been turned on or reset. The homing function will cause the tool changer to move to tool position one, it will also cause each axis to move in the most positive direction that it can.

Do the following Service Code and procedures:

- **Code 505** - Overtravel Soft Limits

Possible Cause	Check This
Door is Open	If the Door is open, a "Door Error" message should be displayed.
Home Switch Failure	Contact TRAK for Service
Servo Drive Failure	Contact TRAK for service.
Motor Failure	Contact TRAK for Service
Computer Module Failure	Contact TRAK for Service

3.3 Computer Related Issues

3.3.1 USB Not Working on Pendant Enclosure

When plugging in a USB device the control does not recognize it. Service Code 540 may be needed depending upon repairs needed.

- **Code 540** - Disable File-Based Write Filter

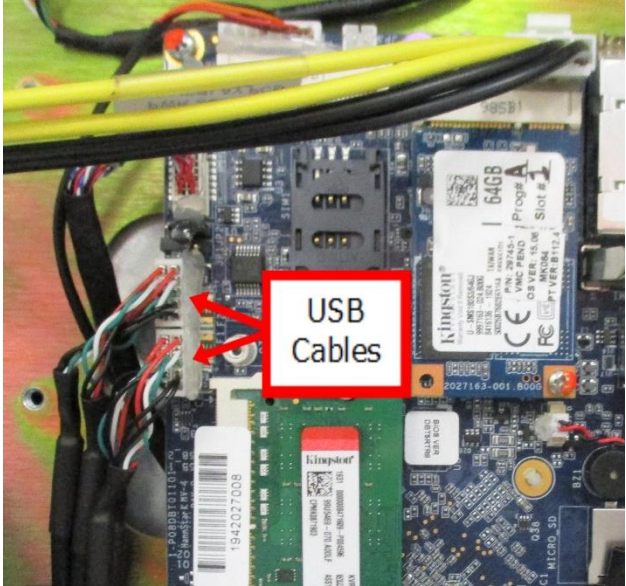
Possible Cause	Check This
USB Drive Not Working	Verify USB works on known good PC, replace USB drive if it failed.
Device Driver Not Loaded on Control	Device driver may not be installed for USB device or be corrupted. Run service code 540 and load USB driver.
Poor USB Cable Connections	<p>Check different USB port. If good problem with previous USB port. Check cable from bad USB to computer board following cable from USB to computer connections as shown on the photo. Make sure both cables are properly seated. Check all USB ports.</p> 
All USB Drives Not Working	This is a motherboard problem, contact TRAK for service to replace programming panel.

3.3.2 Programming Panel Does Not Power On

When you see this symptom, we need to make sure power is getting to the programming panel from the computer module.

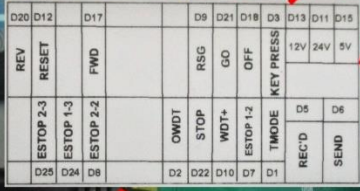
Possible Cause	Check This																																												
Poor Cable Connections	Verify the DB25 pin connector and Computer Module Ethernet cables are connected.																																												
Power Not Getting to Programming Panel	<p>Verify 24 VDC is making it to the programming panel enclosure. Remove programming panel rear cover leaving the two screws at the top for easy removal. Check LEDs on the inside of the programming panel enclosure as shown below. If no LEDs are on, then the computer likely has no power. Make sure the computer module is getting power.</p>  <tr> <td>D20</td><td>D12</td><td>D17</td><td></td><td>D9</td><td>D21</td><td>D18</td><td>D3</td><td>D13</td><td>D11</td><td>D15</td> </tr> <tr> <td>REV</td><td>RESET</td><td>FWD</td><td></td><td>RSR</td><td>GO</td><td>OFF</td><td>KEY PRESS</td><td>12V</td><td>24V</td><td>5V</td> </tr> <tr> <td>ESTOP 2-3</td><td>ESTOP 1-3</td><td>ESTOP 2-2</td><td></td><td>OWDT</td><td>STOP</td><td>WDT+</td><td>ESTOP 1-3</td><td>TMODE</td><td>D5</td><td>D6</td> </tr> <tr> <td>D25</td><td>D24</td><td>D8</td><td></td><td>D2</td><td>D22</td><td>D10</td><td>D7</td><td>D1</td><td>REC'D</td><td>SEND</td> </tr>	D20	D12	D17		D9	D21	D18	D3	D13	D11	D15	REV	RESET	FWD		RSR	GO	OFF	KEY PRESS	12V	24V	5V	ESTOP 2-3	ESTOP 1-3	ESTOP 2-2		OWDT	STOP	WDT+	ESTOP 1-3	TMODE	D5	D6	D25	D24	D8		D2	D22	D10	D7	D1	REC'D	SEND
D20	D12	D17		D9	D21	D18	D3	D13	D11	D15																																			
REV	RESET	FWD		RSR	GO	OFF	KEY PRESS	12V	24V	5V																																			
ESTOP 2-3	ESTOP 1-3	ESTOP 2-2		OWDT	STOP	WDT+	ESTOP 1-3	TMODE	D5	D6																																			
D25	D24	D8		D2	D22	D10	D7	D1	REC'D	SEND																																			

| Motherboard Failure | If 24 volts reaches the programming panel enclosure, then verify the 12 VDC and 5 VDC LEDs are on. If they are on, there is a failure in the motherboard. Check connections. If they are good, replace programming panel. |

3.3.3 Blank Display

VMC2 seems to be operational; however, the display is blank.

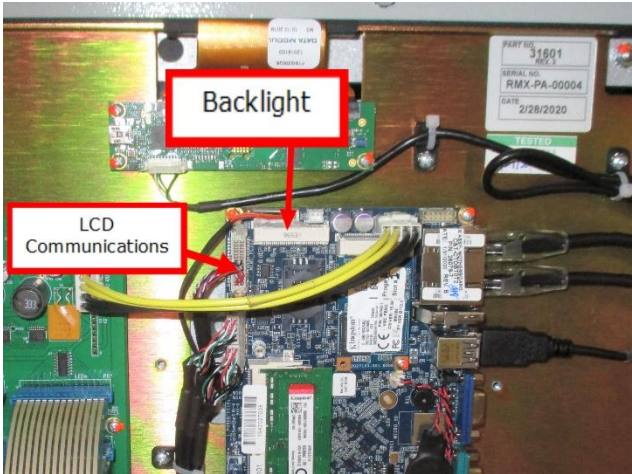
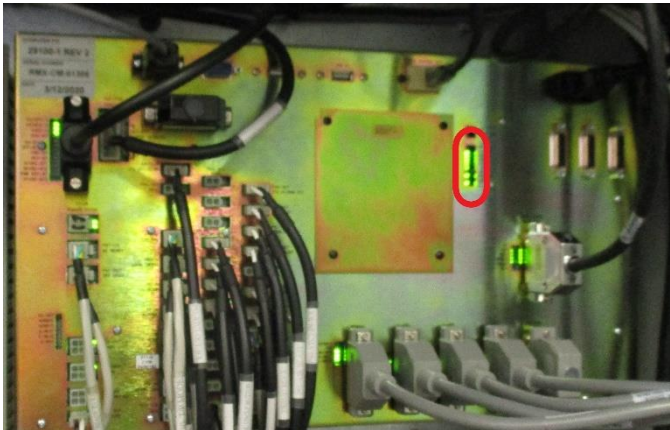
Possible Cause	Check This
Electronics Did Not Power On Properly	Reboot VMC2 by turning off power, reapply power and see if problem goes away.
Cable Connections Loose	<p>Check for working LEDs on run panel, if working press keys on programming panel. Should hear a beep, if not working check two cables (backlight and LCD comm cables) as shown:</p> 
Failure on Programming Panel	Replace programming panel.
Power is Not Getting to Programming Panel	<p>Check for working LEDs on run panel. If LEDs not working, move to electric cabinet and check power cord is plugged into the panel. Then verify LEDs are working in such as: 24V, 5V, 3.3V, and 1.2V as shown below. The 24V is the most important to make sure it is working. If not working, replace computer module.</p> 

3.3.4 White Display

VMC2 has a white display.

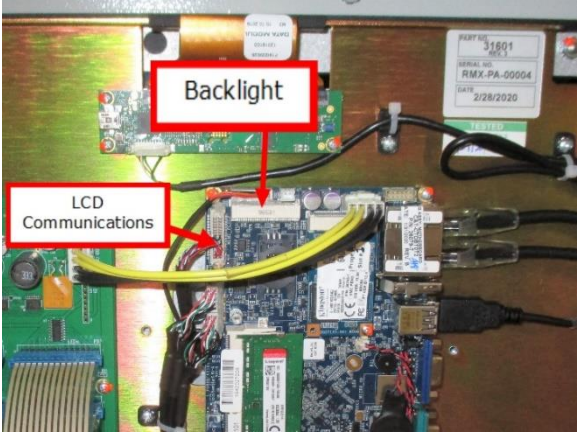
Possible Cause	Check This
Possible LCD Communication Cable Connection Failure	Verify the LCD Communication cable is connected correctly as shown: 
Failure on Programming Panel	Replace programming panel.



3.3.5 System Will Not Boot

VMC2 will not boot up. VMC2 has power, run panel and programming panel are operational. There is text on the screen again a black background. (A flashlight might help to see the reflection of the text on the black screen.)

Possible Cause	Check This
Boot Process Failed on Motherboard	EFI Shell Error displayed on screen, power off VMC2, restart and see if control boots up.
Poor Connection of MSATA Drive to Motherboard	Verify MSATA Drive is attached correctly and single screw is in place as shown below: 
Motherboard Failure	Replace Programming Panel.

3.3.6 E-Stop Error

The Warning button is flashing and has an E-stop message, error code 261. It will not allow the machine to be moved around.

Possible Cause	Check This
Make sure E-Stop switch is out and not pressed.	Clear message and make sure Power Reset button is turned on. If problem persists reboot control and see if message goes away.
Jumper May Have Come Loose	<p>Check removable jumper is in place and connected properly as shown below:</p>  <p>If connected, restart VMC2.</p>
Computer Module Internal Failure	Make sure both E Stop jumper lights are on. If either is off, computer module failure, call TRAK for service. If both are on, more to next step.
Computer Module Internal Failure	<p>Check E-Stop lights in electric cabinet, make sure 2 LEDs are on as shown below:</p>  <p>Either light off, computer module failure, call TRAK. If both are on, move to next step.</p>

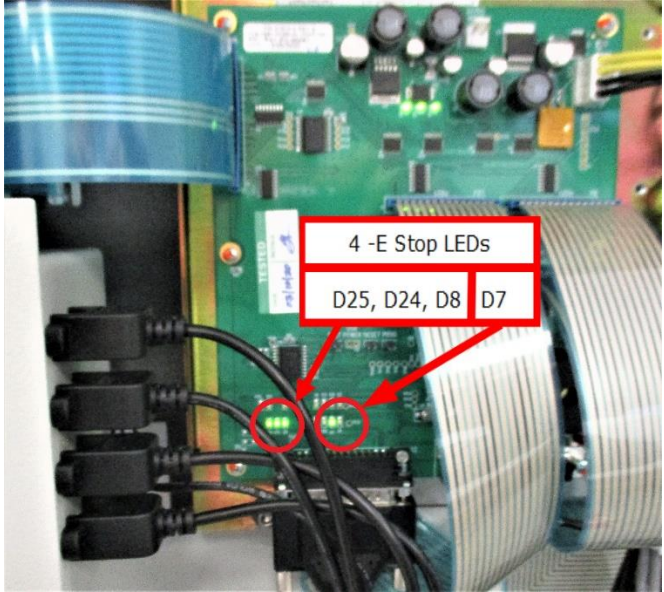
Possible Cause	Check This
<p>LED lights on overlay interface board on programming panel are off.</p>	<p>Check E-Stop 4 LEDs on the programming panel overlay interface board as shown below:</p>  <p>If any of the lights are off, check RS232 cable to electric cabinet. If the connection is good, programming panel likely needs to be replaced.</p>
<p>Faulty E Stop Switch or Wiring</p>	<p>Check E Stop switch inside pendant and its cable to circuit board for connections on both ends. If hardware problem, replace parts, otherwise run panel problem. Call TRAK for service.</p>

3.3.7 Overlay Keys Not Responding

Keys from any section of the Programming or Run Panels are not responding. Do the following Service Code and procedures.

- **Code 81** - Front Panel Keyboard Test

Possible Cause	Check This
<p>Control did not recognize the correct product model.</p>	<p>Run Service Code 81 and verify that the screen displays the same key panels as the VMC2. If wrong key panels, reboot and retest Code 81. If problem persists, contact TRAK Customer Service.</p>

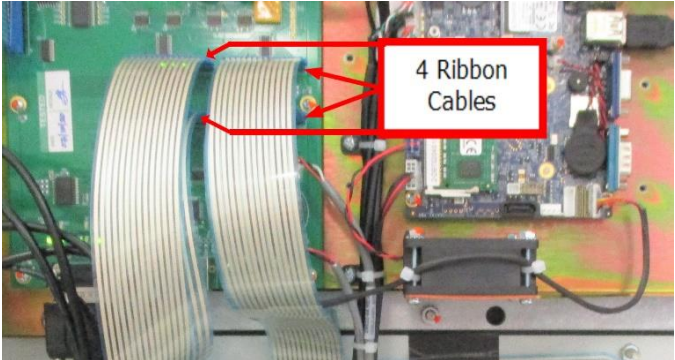
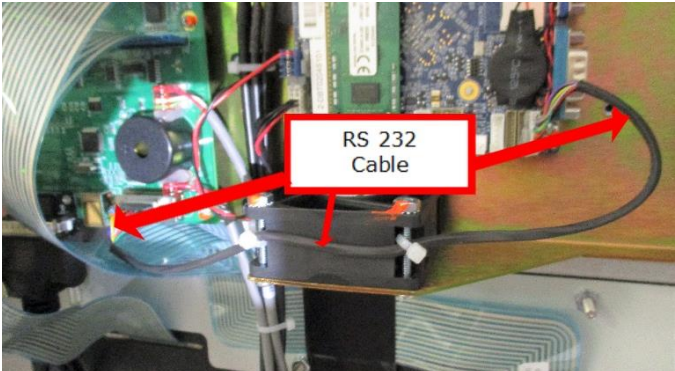
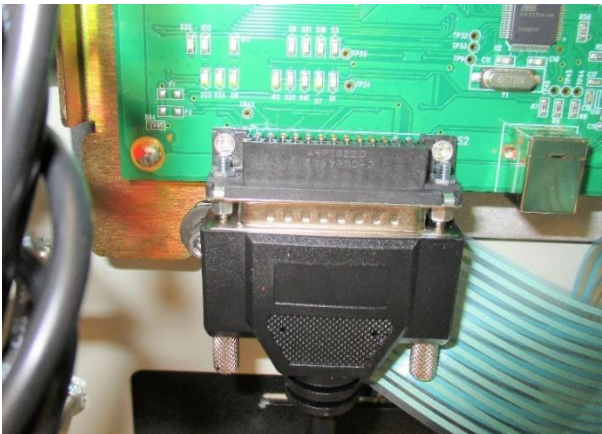
Possible Cause	Check This
<p>Keys work but erratic, some work, some don't.</p>	<p>Open the rear panel and check to make sure all 4 ribbon cables are tight and seated correctly as shown:</p>  <p>If they are, call TRAK customer service. Likely need programming panel replacement.</p>
<p>No Keys Work at All</p>	<p>Check 4 ribbon cables shown above and RS232 cable from overlay PCB to motherboard are seated as shown:</p>  <p>If RS 232 seated correctly, call TRAK customer service.</p>
<p>Connection Problem with DB25 Cable</p>	<p>These are critical keys and can be checked by running Code 81. If problem, check ribbon cables in step 2 as well as DB25 cable on lower left of programming panel as shown:</p>  <p>Likely programming panel problem. Call TRAK Customer Service.</p>

4.0 Tool Changer Problems

When the tool changer has a problem, generally you will get an error messages describing what the problem might be.

4.1 Automatic Tool Changer (ATC) Will Not Move

When a tool change is commanded, the ATC will not advance towards the front of the machine.

Possible Cause	Check This
Is the door open?	Make sure the door is closed and there is no door open message on the screen.
The computer module is not outputting the command to move the ATC.	Check the ATC front LED (D282 - Second LED from the top near P59 connector) output on the computer module.
Compressed air not being supplied to the machine.	Is air connected to the machine? Has the air pressure been turned down at the pressure regulator? It should be set at 90 PSI
Low air pressure. A low air pressure warning should appear on the screen when the air pressure falls below 60 psi.	Make sure the machine is receiving 90 PSI. The tool carrier should still move if the air pressure is low.
Something is obstructing the movement of the ATC sliding assembly.	Switch off the air. Open the ATC cover and try to slide the tool carrier. Visually inspect for any foreign objects that may be preventing the movement of the ATC.
There is an air leak in one of the air lines feeding the ATC in/out pneumatic cylinder.	With the air switched on, inspect the air lines and fittings for a leak.
ATC in/out Pneumatic Cylinder is Faulty	Check for air escaping from the ATC in/out pneumatic cylinder.
The solenoid labeled 2 on drawing 27563-1 has failed.	If the solenoid is receiving a signal from the computer module, then press the red button to fire the solenoid to see if it works when commanded manually. Make sure the table is forward and the Z-axis is raised to clear the ATC.
The ATC door assist cylinder flow controls are closed too much, or the cylinder is jammed so it cannot move.	Check if the cylinder is free to move and pivot. Check if the flow controls on the door lift are set per recommended settings as described in section 6.1.11 of this manual.

4.2 Spindle Will Not Orientate Properly

Each time a tool change is performed, the spindle must orientate the spindle so the dogs line up with the ATC fingers that hold the tool.

Do the following Service Codes and procedures:

- **Code 510** - Spindle Setup, set spindle orientation

Possible Cause	Check This
The coupling that couples the motor to the spindle has come loose.	This is only likely after a heavy crash on the machine. If this happens you will need to perform service code 510 - spindle orientation to resolve the issue.
The spindle encoder is not being read properly.	There is an index mark on the spindle encoder that we are reading to orientate the spindle. Check this by running service code 510. Make sure parameter P2-2 in the AC drive matches the value set in service code 510.
Poor cable connection at spindle encoder, AC drive or computer module.	Check the cable connection at the spindle motor and AC drive. Also check the cable that runs from the AC drive to the computer module.
Spindle Encoder Failure	Verify that all the encoder signals are being sent to the AC drive by verifying the LEDs for Channel A, B and Z are turning ON and OFF when the spindle is rotating.
Spindle drive failure	Replace drive.
Computer module failure	Replace computer module. See section 6.1.5.4

4.3 Tool Will Not Clamp or Unclamp in the Spindle

The automatic draw bar uses pull fingers that close down and pull up simultaneously on the retention knob to lock the tool holder into the spindle taper. These fingers act in the opposite fashion to release the tool holder. Tools can be clamped and unclamped manually by pressing the green button on the head.

Possible Cause	Check This
The control thinks the door is closed when pressing the green button on the head.	The door must be open for the green button to work.
No or Low Air Pressure	There is no air being supplied to the machine. Is the pressure regulator set at 90 PSI? Is there a leak in the pneumatic system?
Are the tool holder(s) or the spindle taper bore dirty?	Examine the spindle taper bore and the tool holder for embedded chips and "tackiness" from excessive coolant residue. Sometimes tools that are worn or have defects on the taper will stick in the spindle.
The retention knob you are using is not correct for this machine.	See section 2 for an illustration of the correct retention knob.
Loose Tool Holder Retention Knob	Check that the retention knob is tightened to the torque value of between 70 and 85 ft lbs.
Belleville washers are damaged, worn or fatigued.	With a BT30 tension gage, check the pull strength of the draw bar, it should be approximately 1000 lbs.
The tool gripper inside the spindle have become loose.	Check the adjustment of the tool gripper.

Possible Cause	Check This
The tool gripper fingers inside the spindle have been damaged.	Remove the gripper and visually inspect for damage and replace as necessary.

4.4 Service Codes

These are the most commonly used service codes for the TRAK VMC2's.

Service codes are broken down into the following categories:

1. Software
2. Machine Setup
3. Diagnostics
4. User Options/Defaults
5. Lube Pump and I/O Testing

All Service Codes are accessed in the SET-UP Mode by pressing the soft key for "SERV CODES". The service codes can be found under one of the headings listed on the main screen. Press the heading you want to access the code in question. If you know code # you want, press the CODE # softkey and it will take you directly to the code in question. Press CODE #, enter the number you want, then press SET.

Warning!
<p>Certain service codes must be performed when servicing certain items on the VMC2. Failure to do so can lead to machine crashes and expensive repair work.</p> <p>Do not work on the TRAK VMC2 unless you have been trained on these service codes.</p>

Please see a table at the end of the service code section for the list of service codes that must be run when certain machine components are worked on.

The Service Codes are divided into logical categories. More detailed information can be found in the table below:

Software Services Codes		
Code	Description	Comment
33	Software, Firmware and PLC Versions	Displays current software versions, master and slave operating system versions, machine ID key and software option versions.
141	Load Configuration File from USB Thumb Drive	To load configuration files from a USB thumb drive to the RX control.
142	Save configuration file to USB thumb drive	To save the configuration files for reloading later. When a computer replacement (Section 6.1.5.4) is necessary, saving the settings to a thumb drive for reloading them later is highly desirable.
316	Update Software	Runs the routine that copies new software from a USB thumb drive device to the ProtoTRAK system. Use this routine to install new ProtoTRAK software.
318	Activate Converter	Displays which software options are turned on. Options in bold letters mean the option is active.

Machine Set-Up Service Codes		
Code	Description	Comment
123	Calibration Mode	Use to calibrate all axis on the RX control
128	Backlash Calibration Constant	Use to compensate for backlash on each axis.
134	Friction Feed Forward Constant	Compensates for friction variance from machine to machine
311	Run Machine with Spindle Off	Allows programs to RUN without enabling spindle.
400	Load foreign language MLS files	Used to download language tables that have been translated into a foreign language.
505	Over-travel Limits	Used to setup and troubleshoot software limits.
510	Spindle Setup	Used to calibrate spindle, orient the spindle in relation to the ATC, and troubleshoot any spindle encoder related issues.
520	Set Tool Changer Locations	Define locations for each tool change position along the X, Y, and Z axis.
530	Serial Numbers	Display serial numbers of major VMC2 components
540	Disable File Based Write Filter	Enable is default. Disable allows changes to Windows system settings (i.e. network or driver changes). Note - Save any programs in memory, this command forces a system reboot.

Diagnostic Service Codes		
Code	Description	Comment
1	Program, File, Log, Backup	Stores a file to flash drive documenting VMC2 operations for debugging uses.
54	Continuous Run Mode	Cycles through the program in current memory.
81	Program Panel Keyboard Test	Gives a tone feedback to a button push and highlights the button.
131	Manual DRO	Turns off servo's so you can check encoders.
132	Electronic Handwheel Test	Test the EHW signals.
314	Toggle Test Lights in Status Line	Used for troubleshooting control issues.
319	Error Logging	Logs the machine as it runs.
320	Fault Log	Displays fault history.
326	Error Message Display	Displays error messages on screen
327	Display Memory Check	Displays memory availability of various devices
521	Check Control/Indexer IO	Launches application to test all system I/Os
522	Diagnostic Charting Tool	Diagnostic used for plotting various inputs

Operator Defaults/Options Service Codes		
Code	Description	Comment
79	Turn On Beeper	Turn the beeper on or off when pressing keys on either of the front panels.
328	EPA On/Off	Enables/Disable EPA section.
600	Manager User Profiles	Allows user to define multiple user profiles for machinists accessed in DEFAULTS section

Lube Pump Setup Service Codes		
Code	Description	Comment
300	Lube Pump Switch Discharge	Allows the user to manual discharge the lube pump.
301	Set Lube Pump Cycle Time	Sets the time in minutes between pumping cycles.
302	Set Lube Pump Discharge Time	Sets the time in seconds for how long to pump for each cycle.

4.4.1 Section A - Software Code Details

The following codes pertain to software functions in the control. To get to any of these codes go to Service Codes, press "A" and press the code you wish to view.

Note - If you are working with the SWI Customer Service Group, write the values down for Code 33. These values will be valuable for troubleshooting.

4.4.1.1 CODE 33: Software ID

The Code 33 is the software identification procedure. This will most likely be used when a customer service representative asks to identify what version(s) of software is being run on your machine.

4.4.1.2 CODE 141: Load Configuration File from USB Flash Drive

This code allows you to load your configuration file from a USB flash drive to your machine's internal drive. The configuration file consists of items such as calibration, backlash constants, ball lock locations, base tool length and tool changer height. This code is useful when a computer module or pendant has been replaced, and you want to restore a machine to its previous state.

In order to load the files correctly on the VMC2, the file name must be in the following format: "RMX Configuration Machine ID" to where the machine ID is the number of the VMC2.

4.4.1.3 CODE 142: Save Configuration File to USB Flash Drive

This code allows you to save your configuration file to a USB flash drive. It is used when a computer module or pendant needs to be replaced and stores the configuration file from the machine's internal drive to a portable USB flash drive. The configuration file consists of items such as calibration, backlash constants, base tool length, and tool changer locations. It is suggested to apply this code after the machine is initially setup, so these values are saved and are easily accessible in the future. If the computer or pendant fails, then you will not have the ability to save the configuration file and the machine will need to be re-setup when the computer or pendant is replaced.

4.4.1.4 CODE 316: Update Software

Insert the USB flash drive that contains the software update and press this service code. Upon doing so, the new software will automatically begin to download.

Note - The control may need to be shut down if prompted to do so.

4.4.1.5 CODE 318: Activate Converters or Options

This service code will allow you to check the status of, or activate any available converter or option for the machine.

4.4.2 Section B - Machine Set-Up Code Details

The following codes are primarily used when setting up a new machine. To get to any of these codes go to Service Codes, press "B" and press the code you wish to view.

4.4.2.1 CODE 123: Calibration

See Section 6.1.10 for a further explanation of this code.

4.4.2.2 CODE 128: Input Backlash Constant

Code 128 allows you to enter the backlash values for each axis. The value is displayed after it is entered.

4.4.2.3 CODE 134: Friction Feed Forward Constant

This is a tuning parameter for adjusting the machine's friction characteristics. It is set at the factory by running a ballbar plot using a measurement probe device, such as one made by Renishaw, and adjusted to obtain minimal error. It is not recommended to change the values unless told to do so by a TRAK Service Representative.

4.4.2.4 Code 400: Update Foreign Language MLS Files

If you have received a foreign language update for your machine, you load it into a USB flash drive, and enter this service code to update your control.

4.4.2.5 Code 505: Over Travel Limits

When entering this service code, both of the soft limits will be disabled to allow for setup or troubleshooting. If a soft limit is triggered, it will stop the motor from moving any further, but will not fault out or kill power to the motor.

In addition to the DRO, the motor index angle for each axis relative to the limit switch can be seen. This is to ensure that the index pulse for the motor is close to 180 degrees when it hits the limit switch. This is done to obtain maximum reliability when the machine performs its homing routine. The angle should be 180 degrees +/- 45 degrees. Values from 135 to 225 degrees are acceptable. Failure to set this correctly may cause the machine to not home properly which can lead to major problems.

- **SOFT LIMIT ON / OFF** – You can choose to toggle the soft limits on or off. They will default to off when entering this service code, but will always turn back on after exiting.
- In order to find the index angle, you manually select the desired axis and then carefully move it using the handwheel. When the home switch banner lights up on the screen you are able to view the index angle.

4.4.2.6 Code 510: Electronic Spindle Setup

Use this service code to setup or troubleshoot the electronic spindle.

1. **CAL RPM** – Running this routine will automatically calibrate the spindle over several increments from its minimum to maximum rated speed. The process should take between 1-2 minutes to complete.
2. **ORIENT SPINDLE** – Sets the orientation of the spindle in relation to the ATC when the machine performs a tool change. Follow the instructions on screen to set or verify the orientation of the spindle.
 - a) **ATC FRONT** – Brings the ATC carrier to the front of the machine, towards the user.
 - b) **ATC BACK** – Moves the ATC carrier towards the back of the machine, away from the user.
 - c) **ORIENT ON / OFF** – Pressing this button will make the spindle turn to the orientation offset that is currently saved, and hold position. Pressing it again will release the spindle so that it can be turned manually if necessary.
3. **ENC CHECK** – Use to verify the spindle encoder is functioning properly. For every revolution of the spindle, you should see 2048 counts on the screen. The counts should also reset to 0 once the encoder reaches the index pulse. You can turn the spindle manually, or use **SPIN SPEED** to enter an rpm, and press FWD to power on the spindle.

4.4.2.7 Code 520: Set Tool Change Locations

Use this service code to set the 8 ATC locations. The locations are relative to the machines home position.

Follow the directions on the screen shown in figure 4.4.2.7. Note inset in figure 4.4.2.7 shows a sample Input Table as referenced in the directions. All 8 locations should be set by using a dial indicator to sweep in the taper on a tool. The X and Y coordinate should be within 0.005” or so on your indicator. In other words, there is some room for error, but these tool locations cannot be set by eyesight.

BACK	X COORD	Y COORD
1	-14.2000	0.0618
2	-8.4358	0.0720
5	-5.5260	0.0787
6	0.2260	0.0622

FRONT	X COORD	Y COORD
3	-14.2000	-3.0878
4	-8.4311	-3.0783
7	-5.5248	-3.0819
8	0.2287	-3.0843

Z TOOL CHANGE	
	-11.6220

INFO	CODE 520 - Set Tool Changer Locations (X,Y,Z)	MODES
STATUS	To set your tool change positions: 1. Jog the Z axis up to the limit.	X -1.0000 H DRO
TOOL TABLE	2. Press "ATC FRONT" to move the ATC to the front.	Y -1.0000 H PROG
EPA	3. Press "INPUT TABLE" to enter data.	Z -1.0000 H EDIT
MATH HELP	4. Individually measure tool locations 1 through 8 and enter a value for X and Y.	SET-UP
DEFAULTS	5. Fill in the value for the Z tool change location.	RUN
KEY BOARD	6. When complete, press "ATC BACK" to return ATC.	PROG IN/OUT
CALC		
ATC FRONT	ATC BACK	INPUT TABLE
	TURN OFF LIMITS	RETURN

Figure 4.4.2.7 - Service Code 520 Instructions

The Z tool change height is defined as the location that Z axis must go to load a tool into the ATC. Service code 520 will take you through the procedure for setting the tool change height. It will set the position where the Z-axis will clamp or unclamp the tool. Like the spindle orientation, this setting is also very critical.

During this procedure you will hear the "air through spindle" hissing sound, this sound is actually a valuable tool for this procedure. As you near the proper tool change height while performing service code 520, you will hear the sound of the air slowly being blocked off, simply creep down at .002" jog feed rate until the sound of the air hissing just disappears, then back it off one click and a slight sound of air will once again be heard. That is the proper tool change height.

It should be noted, that the tool clamping mechanism will give the 30-taper tool holder a slight bump of ~0.020" during the "Unclamp" cycle, to help dislodge the tool holder from the spindle. Likewise, it will give the tool holder a slight tug at the "Clamp" cycle. This action is both normal and proper.

Any improper setting of the tool change height would result in unnecessary stresses on the gripper assemblies and the tool magazine.

Once you have all tools set properly and the Z height, press the "SAVE TABLE" button to save all tool locations.

4.4.3 Section C - Diagnostic Code Details

The following codes are used primarily when diagnosing a problem with the machine. To get to any of these codes go to Service Codes, press "C" and press the code you wish to view.

4.4.3.1 Code 54: Program Continuous Run

This code runs a program continuously without stopping for GO commands. It is helpful in running a long period to identify an intermittent problem. To use:

1. Prepare a program as you normally would.
2. Press **MODE, SET UP, "C", Code 54, INC SET**. The program run will start automatically.
3. Press **STOP** to stop, and **GO** to continue.

4.4.3.2 Code 81: Program Panel Test

This code is used to check if the buttons located on the program panel are functioning correctly. It allows you to test each key individually. When pressing the keys, the corresponding box for that key will highlight on the screen. The pendant will also beep, indicating that the key is working correctly. If one of the keys does not work, the program panel assembly or run panel may need to be replaced. If none of the keys are working, you may want to check the connections from the back of the program panel or run panel to the overlay interface board.

4.4.3.3 Code 131: Manual DRO

A manual diagnostic routine used to check the motors' encoders. Manually turn the X or Y axis ballscrew to display the actual DRO counts and the raw encoder counts. The DRO will display counts unaffected from calibration compensation.

4.4.3.4 CODE 132: Electronic Handwheel Test

This service code can be used to troubleshoot issues seen with the electronic handwheel. Simply turn the handwheel in either direction, and the display should increment 1 count per click, 100 counts per revolution.

4.4.3.5 Code 314: Toggle Test Lights 'On' in Status Line

This code toggles a group of test lights on the top of the display when turned ON. The lights are used to help determine if there are any communication problems between the computer and the motion control hardware. They would ideally be used for issues where the control appears to be slow to respond, or not responding at all, especially when trying to run a program. A TRAK Service Representative may ask you to turn these lights on and describe their status while troubleshooting.

4.4.3.6 Code 319: Error Log

When turned on, this code captures the commands that were sent to the servo system. It includes items such as positioning commands, errors, stop and go commands, feed rates, etc. It may be helpful for identifying problems between programmed commands and executed commands. To turn the error log ON or OFF, press the F6 softkey. Use the left and right arrow keys to scroll through the file one page at a time. Use the up and down arrow keys to scroll through the file one line at a time. The DATA BOTTOM key takes you to the bottom of the file. Once at the bottom of the file, the key toggles to read DATA TOP which can be selected to take you back to the top of the file. The file will capture data until the file reaches a size of approximately 20 MB. At this time, the file is saved to a backup file, the original file is cleared, and data is once again captured. Once again, as the file reaches 20 MB it copies over the previous backup file. From here, you can save the file to a USB flash drive by pressing the F8 softkey. The file will be saved as a zip file to your USB device. The file will be called errorlog.zip. To clear the contents of the current log, press the CLEAR FILE button.

4.4.3.7 Code 326: Error Message Display

Useful for checking error messages if the error number is already known.

4.4.3.8 Code 327: Display Memory Check

This service code is used checking the amount of free memory available from system RAM. This can be useful for troubleshooting any issues where memory may be a factor, such as system slowing down, or intermittently not responding. Press the **DRIVE SPACE** button to check the amount of free space on the system drive as well as removable devices such as USB flash drives. A service technician may ask you to take note of these screens while troubleshooting certain computer related issues.

4.4.4 Section D - Operator Defaults/Options Codes Details

The following codes allow the user to set programming defaults or turn features on or off. To get to any of these codes:

1. Go to Service Codes.
2. Press "D"
3. Press the code you wish to view.

4.4.4.1 Code 79: Beeper On/Off

This turns the beeper on or off to operation of the control keys.

4.4.4.2 Code 521 - Check Control /Indexer IO

This service code launches an external application that can be used to check all the control's inputs and outputs. This service code should only be used by qualified Service Technicians.

4.4.4.3 Code 530: Set Machine and Computer Module Serial Numbers

In order for the machine to be fully functional, the system requires both, the serial # from the machine and computer module to be entered. When you receive your new machine, the serial numbers should already be entered and ready to go. However, if you were to ever replace the computer module, then the serial numbers will need to be entered upon installation.

To enter the machine's serial #, press MACHINE SERIAL and then use the alpha matrix to enter your machine's serial #, which should be found on an outside sheet metal plate on the machine.

To enter the computer module's serial #, press COM MOD SERIAL and use the alpha matrix to enter the serial #. The computer module is found in the back of the machine, inside the electrical cabinet. It is the main component on the lower left corner, and should have a visible sticker with the serial # on it.

4.5 Critical Service Codes that Must Be Performed

The following table summarizes the critical service codes that must be performed after working on certain aspects of the machine.

#	Service Code	When	Consequence
1	505 – Checking the motor index angle. (Must be set to 180° +/- 45°)	<ol style="list-style-type: none"> 1. Motor removed or replaced 2. Ballscrew coupling slips 3. Limit switch replaced or a major mounting adjustment is made. 4. Limit switch cam replaced or a major adjusted is made. (This only applies to the limit switch cam used for homing.) 5. Ballscrew replaced 6. Angular contact bearings on motor end replaced 	<ul style="list-style-type: none"> • This code applies to any work done to the X, Y and Z axis. • As a secondary item, you should rerun this same code and reset the soft limits.
2	510 – Setting the Spindle Orientation Angle	<ol style="list-style-type: none"> 1. Spindle motor belt has been removed, replaced or has slipped during operation 2. Spindle motor has been replaced 3. AC spindle drive has been replaced (Need to reset parameter 10-19, each machine has a unique value) 4. Computer module or compact flash has been replaced and the configuration file was not loaded into the new computer. 	<ul style="list-style-type: none"> • The user will most likely break a finger on the ATC. More severe damage could also occur which could be costly to the user.
3	520 – Setting Tool Change Locations	<ol style="list-style-type: none"> 1. Motor removed or replaced 2. Ballscrew coupling slips 3. Limit switch replaced or a major mounting adjustment is made. 4. Limit switch cam replaced or a major adjusted is made. (This only applies to the limit switch cam used for homing.) 5. Ballscrew replaced 5. Angular contact bearings on motor end replaced 	<ul style="list-style-type: none"> • This code applies whenever Service Code 505 is run.

5.0 Diagnostics

This section explains the diagnostic procedures used to isolate service problems.

5.1 The Machine Tool & Set-Up

5.1.1 The Milling Machine Checklist

The following is a quick reference for the types of problems that may arise if problems are noticed in these areas.

Problems With	Can Contribute To	Most Suspect When (and why)
Spindle Bearings <ul style="list-style-type: none"> See Spindle Cartridge Replacement 	<ul style="list-style-type: none"> Noisy head Parts incorrect Circles out of round 	<ul style="list-style-type: none"> Older machines, machines that are pushed hard. Run spindle at high RPM's for long periods of time.
Lubrication System	<ul style="list-style-type: none"> Premature wear of ball screws and linear guides. Poor part finish 	<ul style="list-style-type: none"> New installations (may not be hooked up or line sheared).
Linear Guides Worn	<ul style="list-style-type: none"> Poor finish Out of round circles Faulting 	<ul style="list-style-type: none"> Inadequate lubrication. It should take many years for this to become a problem.
Machine Not Leveled Weight Not Distributed Evenly on All 4 Feet <ul style="list-style-type: none"> See Leveling procedures 	<ul style="list-style-type: none"> Parts incorrect Machine geometry off, i.e. tram. 	<ul style="list-style-type: none"> New installation, after moving machine or heavy crash.
Head Out of Tram	<ul style="list-style-type: none"> Leaves uneven surfaces on bottom of pockets. Circles are not round when circularity is checked. 	<ul style="list-style-type: none"> Machine not leveled or after a heavy crash.
Water in Your Air Lines	<ul style="list-style-type: none"> Faulty solenoid valves Rust Problems with the pneumatics on the tool carrier and tool change air cylinder 	<ul style="list-style-type: none"> User does not drain air regular/water separator on a regular basis. User's shop has a poorly designed air system with no air dryers to prevent water from entering lines.
Performing periodic maintenance such as checking oil cup on tool unclamp cylinder and greasing fittings on ATC.	<ul style="list-style-type: none"> Lack of lubrication to cylinder and premature failure Wear of sliding surfaces on ATC and premature failure 	<ul style="list-style-type: none"> User does not perform recommended periodic maintenance on machine tool.

5.1.2 A Special Word About Linear Guides

The linear guides on your VMC2 are vital to the performance of the machine.

They should require very little maintenance over the life of the guides. It is recommended that these guides be inspected for any signs of excessive wear. Lubrication is the key to the longevity of the guides so it is important to verify oil is reaching the guides. It is also a good idea to make sure no cutting fluids or chips are reaching the guide surfaces. Periodic cleaning or inspection of the guides is recommended.

It is good machining practice to avoid the use of shop air to clean the chips off a machine. Failing to avoid the use of shop air to clean the chips off the machine, risks blowing chips into the linear way surfaces and compromising the performance of the machine.

5.1.3 Lubrication

Lubrication is one of the single, most important maintenance issues and plays a key role in assuring the performance and durability of the machine. The ProtoTRAK will automatically lubricate the machine when it is turned on. At the beginning of the day, if the machine has been left on overnight, it is recommended to go to service code 300 to lubricate the guides and ballscrews.

Lack of lubrication using recommended type of lubricant can lead to a variety of problems with your machine motion due to increased friction in the sliding ways. This increased friction may lead to part inaccuracies and decreased life expectancies of your ball screws and linear guides.

5.1.4 Machining Set-Up

The machining set-up can greatly influence the performance of your mill. Be aware of the following:

Problems With	Can Contribute To
Feed and Speeds (spindle rpm) <i>See below.</i>	<ul style="list-style-type: none"> • Poor finish • Machine chatter • Excessive speeds and feeds can break cutting tools or wear tools prematurely.
Poor tooling, using the wrong cutter for an application, or entering the wrong size diameter.	<ul style="list-style-type: none"> • Poor finish • Tool chatter • Parts incorrect size
Cutting too deep	<ul style="list-style-type: none"> • Part dimensions incorrect • Driving and cutting forces cause deflections, since no material is totally rigid • Machine chatter
No coolant	<ul style="list-style-type: none"> • Poor finish, decrease the life of the cutter.

5.1.4.1 Spindle Speeds

Spindle speeds are influenced by a number of variables:

- Material
- Rigidity of the Machine Setup
- Coolant
- Cutter type, material and diameter
- Cutting Depth

As a general rule:

- Lower spindle speeds are used to machine hard or tough material or where heavy cuts are taken.
- Higher spindle speeds are used to machine softer materials in order to achieve better surface finishes. Higher speeds also apply when using small diameter cutters for light cuts on frail work pieces and delicate setups.

Note - *Cutter diameter greatly affects spindle speeds. The larger the diameter, the lower the spindle speed.*

5.1.4.2 Feedrates

Factors that affect feedrates:

- Depth and width of cut
- Design or type of cutter
- Sharpness of the cutter
- Workpiece material
- Type of finish or accuracy required
- Climb or conventional milling

If a fine finish is required, reduce the feed rather than increase the spindle speed. Cutters are dulled by higher spindle speeds rather than high feed rates.

5.2 The Mechanical Drive Train

The following sections talk about a key number of mechanical items that should be reviewed when a mechanical problem exists on the VMC2 machine.

5.2.1 Ballscrew Alignment

Ballscrew alignment plays a critical role in making sure the machine performs at its highest level. It is very important to have consistent rolling torque values across the length of the X and Y-axis ballscrews.

Note - *The Z axis has a mechanical brake so it is not possible to measure the torque.*

When values vary by more than a few inch-lbs across the length of the ballscrew, then this points to the ballscrew not being properly aligned.

To measure the rolling torque on the X and Y-axis you need to move the axis to the location you wish to check and then press the E-stop. This turns the axis motors off and allows you to manually turn the ballscrew with a torque wrench. The torque wrench is placed on the end opposite of the motor in the hex drive. We recommend each axis be checked in 3 places. Check the rolling torque in the center of travel and at both ends of travel.

Note - *Ball screws are inspected throughout their entire travel for backlash and consistent torque. A ball screw should be good for millions of inches of travel if installed properly. Do not be too quick to replace a ball screw if there is insufficient indication that it is bad; this will just be a costly delay to resolving the real problem.*

5.2.2 Protecting the Axis from a Crash

The machine has a few means to help prevent crashes. The first line of defense is a soft limit that is built into the software. The values are set from the factory and can be found in service code 505. In addition to the software limits, each axis has rubber bumpers on either end to prevent a hard crash into a hard stop.

5.2.3 Z Axis Mechanical Brake

The Z axis contains an electro-mechanical safety brake that automatically engages when the electrical power is removed from the machine, or when the E-stop is pressed. This brake is required to support the head and keep it from falling when the servomotor is turned off or disabled. When 24 volts is applied to the brake, the brake disengages from the ballscrew, allowing the motor to move the Z axis up and down. When power is removed from the brake, the brake engages and stops the ballscrew from rotation.

5.2.4 Linear Guides

The linear guideways play a very important role in the drive system of the machine and with proper care and lubrication, they should last many years. They require no additional service nor are there any provisions for adjustment. Great care must be taken to protect the linear guideways. Never operate the VMC2 with the way covers removed (except when service requires it). NEVER ALLOW ANY OBJECT TO FALL ONTO THE LINEAR GUIDEWAYS!

5.2.5 Lubrication

The automatic lubricating system is dedicated exclusively to the ballscrew and the linear guideways on this machine. The amount of oil and how often oil is applied is controlled by service code 300. See Service Code 300 for information to apply oil. The ATC linear guide blocks that the ATC moves on, needs to be manually lubricated with grease. There is 1 grease fitting for each of the 2 guide blocks. The lubrication pump reservoir oil level must be checked daily and maintained in the indicated Min/Max range. If the lube pump level gets too low or the pressure is low, the control will create a flashing warning message on the screen. If the lubrication problem is not addressed, the machine will eventually create a critical error message and not allow the machine to run until the problem is resolved. The software will allow the current program to finish before creating a critical error.

5.2.6 Way Covers

The Z ballscrew cover is telescoping in design, so alignment is important to avoid binding, way covers must be attached in the near fully collapsed state. This is the best way to align the covers to the axis. Do not move axes around with covers detached but still in the enclosure. The X axis and linear guides on the Z axis are protected with accordion style covers. The Y axis linear guideways are mostly unprotected, but are mounted upside-down underneath the Y-axis casting, therefore are not directly exposed to the normal hazards of the milling environment.

6.0 Procedure for Replacements & Maintenance

6.1 Replacements

6.1.1 X Axis Motor Replacement

6.1.1.1 Removal of the X Motor

Warning!

Whenever the X or Y axes motors are removed, Service Code 520 must be performed **AFTER** index angles are set and machine has been homed. This re-establishes the precise location of all eight tool locations of the ATC.

1. Remove RH side enclosure sheet metal cover(s) to access X axis motor, see Figure 6.1.1.1a.



Figure 6.1.1.1a - X Axis Motor

2. If the machine can be jogged under power go to Service Code 505 and jog the X axis to the far right until the "POS X AXIS LIMIT SWITCH" flashing message warning appears on the screen. We are doing this to make it easier to reset the index angle on the motor once it is replaced.
3. If machine cannot be jogged under power, perform the following:
 - a. Loosen the screws on the motor and remove the belt.
 - b. With a 6mm Hex wrench, rotate the ball screw moving the axis all the way to right until it contacts the bumper.
 - c. Back off one full turn of the ball screw.
4. Shut down power to the machine.
5. Remove the 3 SHCS holding the X axis motor to the casting and the belt.
6. Carefully maneuver the motor out from the machine casting exposing the cable connections. See figure 6.1.1.1b.

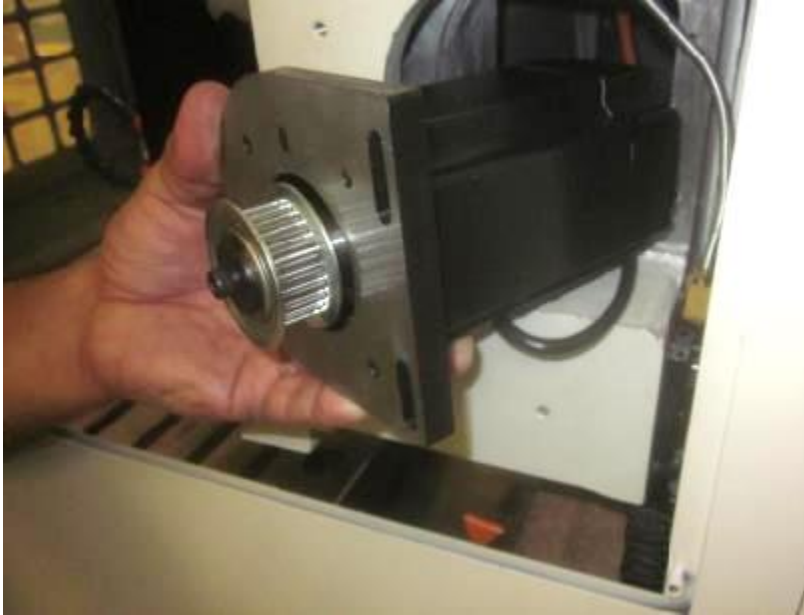

Figure 6.1.1.1b - Removing X axis Motor

7. Place the motor on the shelf area above the mounting cavity. Disconnect the encoder and power cables. See figure 6.1.1.1.c.



Figure 6.1.1.1c - Figure Cable Disconnection

8. Remove the four SHCS with lock washers attaching the motor and separate the plate from the motor.

6.1.1.2 Installation of the X Motor

1. Attach mounting plate to the new motor (if not previously performed). **Cables face down and the round end of the plate faces toward front of machine when installed.** Torque the M6 SHCS with lock washers to 7 ft-lbs.
2. Place the motor on the shelf portion of the X motor casting above the motor cavity. Connect the encoder and power cables.
3. Maneuver the motor into the cavity using care to not damage the cables. Loosely fasten the motor bracket with 3 SHCS with lock and flat washers.
4. Power up the machine. (**Note** - The machine must be powered down when replacing the motor so the new motor and servo can sync themselves.) Go to service code 505. (**Note** - The machine reads "0" for all axis.)
5. Press the "X" axis button (medium resolution) and rotate the hand wheel 2 or 3 revolutions and stop at 180 degrees to set the motor index angle.
6. Install the belt, set the tension (do not over tighten), re-assemble and torque the M6 motor bracket screws to 7 ft-lbs.
7. Home the machine.
8. Go to Service Code 505 and double check your index angle.
9. Check the Index Angle by slowly jogging the X axis to the right until the "X AXIS HOME SWITCH" flashing warning appears on the screen. Spec 180 + or- 45. See figure 6.1.1.2.

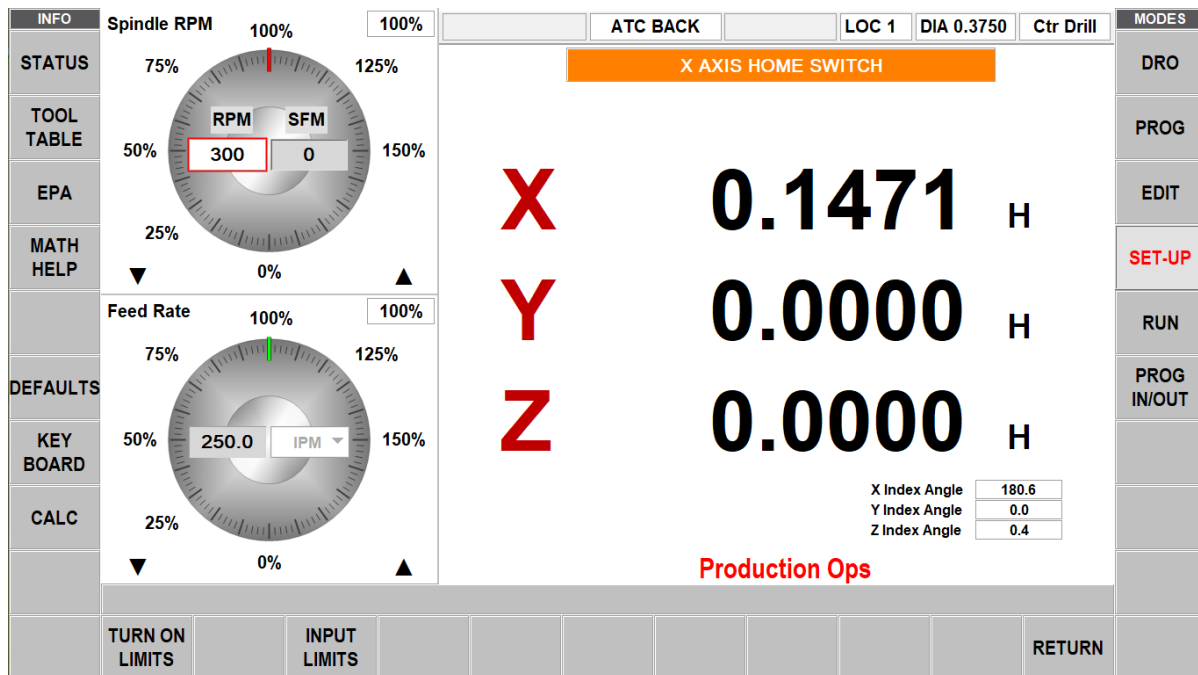

Figure 6.1.1.2

10. Note the Index Angle number and adjust as necessary. Remember to "Home" the machine if you re-adjust the index angle. Specification is 180 degrees +/- 45 degrees.
11. Go to Service Code 520 and check the tool locations for all eight tools. Adjust if necessary.
12. Reinstall all covers.

6.1.2 Y Axis Motor Replacement

6.1.2.1 Removal of the Y Motor

1. If the machine can be jogged under power go to Service Code 505 and jog the "Y" axis forward (use the finest resolution when you get near the limit switch) until the "POS Y AXIS LIMIT SWITCH" flashing warning message appears. Just like shown in figure 6.1.1.2, but for the Y axis. Note the displayed Index Angle.
2. If the machine cannot be jogged under power, perform the following:
 - a. Locate the Y axis motor underneath the ATC area of the machine.
 - b. Remove the upper adjustment screws on the motor. Loosen the lower screws (mounting plate is slotted) and lift the motor up and off the mounting plate removing the belt with the motor.
 - c. Using a deep 6mm Hex socket, rotate the ball screw moving the table forward until it contacts the bumper.
 - d. Back off one full turn of the ball screw.

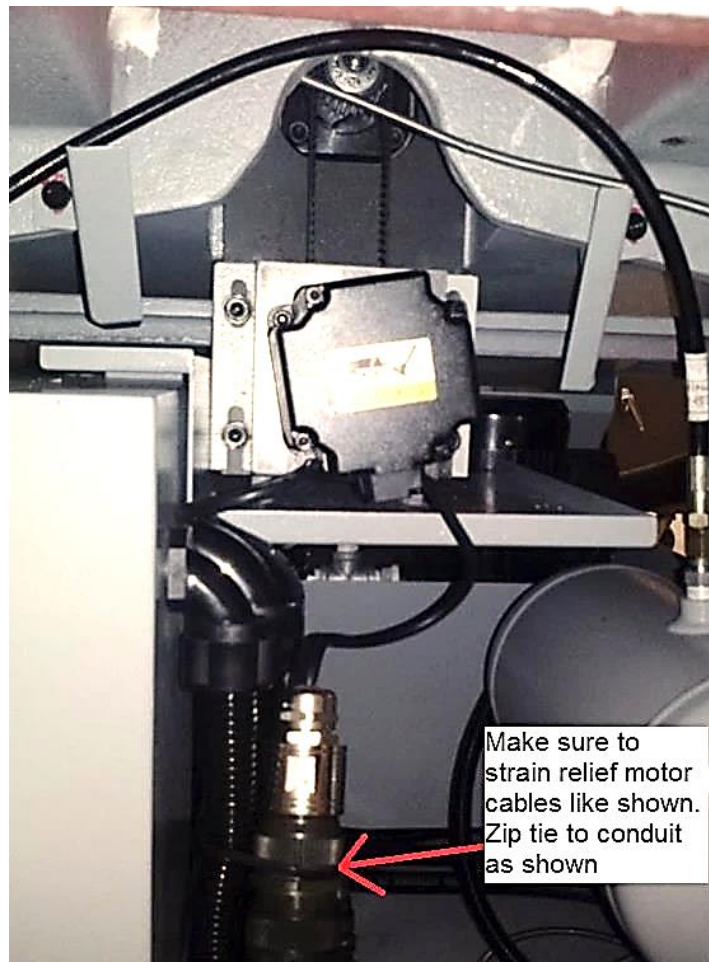

Figure 6.1.2.1 - Disconnect Cables

3. Power down the machine.
4. Locate the Y-axis servo motor at the lower rear section of the VMC2 Mill. Disconnect the encoder and power cables from the machine. See figure 6.1.2.1.

6.1.2.2 Installation of the Y Motor

1. Attach the new motor to the motor bracket with M6 SHCS's and tighten to 7 ft-lbs. Make sure cables are point down from the motor when installed.
2. Attach the encoder and power cables to the motor. Turn on the machine and go to Service Code 505. (**Note** - *The machine reads "0" for all axis.*) Rotate the hand wheel 2 or 3 revolutions stopping at 180 degrees.
3. Install the motor. Set the belt tension (do not over tighten). Torque the M8 bolts to 18 ft-lbs for the motor bracket.
4. Restart the machine and "Home" the machine. The machine must be powered down when replacing the motor so the new motor and servo can sync themselves.
5. Go to Service Code 505.
6. Check the Index Angle by jogging the 'Y' axis slowly forward until the "POS Y AXIS LIMIT SWITCH" flashing warning message appears. See figure 6.1.1.2 above.
5. Note the Index Angle and adjust if necessary. Remember to "Home" the machine if you adjust the Index Angle. Specification is 180 degrees +/- 45 degrees.
6. Go to Service Code 520 and check the tool locations for all eight tools. Adjust if necessary.

Warning!

Whenever the X or Y axes motors are removed, service code 520 must be performed **AFTER** index angles are set and machine has been homed. This re-establishes the precise location of the tool pockets of the ATC.

6.1.3 Z Axis Motor Replacement

6.1.3.1 Removal and Replacement of the Z Motor

1. Locate the Z axis servo motor at the top of the column of the VMC2 Mill.
2. If the machine can be jogged under power, lower the Z axis so the sheet metal clears access to the motor coupler as shown in Figure 6.1.3.1a.

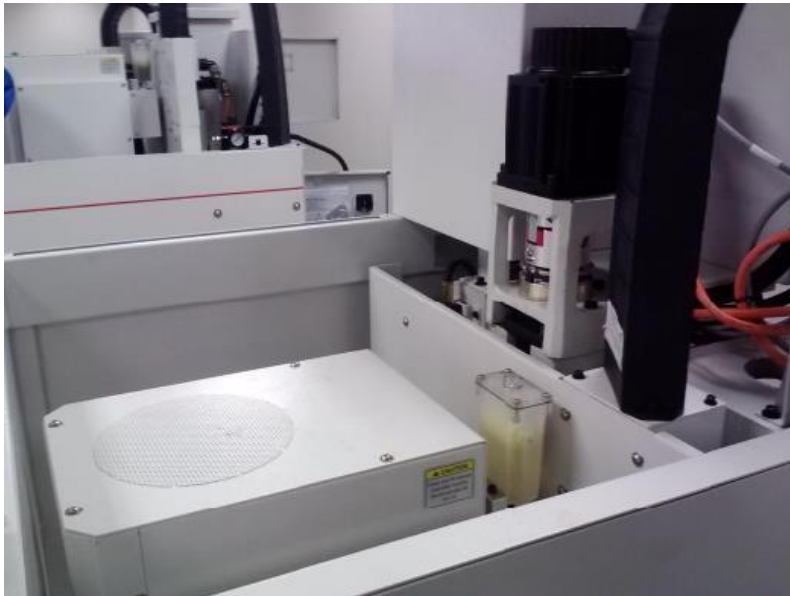

Figure 6.1.3.1a

3. If the machine cannot be jogged under power, perform the following steps:
4. Power off machine.
5. Support the Z axis with wood blocks to prevent dropping in case the brake has failed (unless the Z axis has bottomed out).
6. Unplug the Z axis brake wire at the computer module. The brake will hold with no power to it (unless the brake has failed). Disconnect the encoder and power cables.
7. Remove the four SHCS that mount the motor to the machine and if necessary, lift the motor with one half of the coupler attached. See Figure 6.1.3.1b.
8. Remove the coupler half from the old motor and install it on the new one. Use a depth gage to set the position of the coupler to maintain its gap of about .100." Snug up the coupler screws.



Figure 6.1.3.1b

9. Re-install the new motor and connect the power and encoder cables.
10. Power up the machine. Connect the Z axis brake wire at the computer module and engage the servos (which will hold the Z axis). Go to Service Code 505 and slowly raise the Z axis until the Limit Switch lights noting the index angle number.
11. Lower the Z axis until the motor coupler is accessible as shown in 6.1.3.1a, stopping at the number noted when the limit switch activated. Disconnect the Z axis brake wire from the computer module. Loosen the lower coupling bolts and using the EHW, rotate the motor to 180 and snug up the bolts.
Note - *It may be necessary to rotate the Z axis to gain to access to all the coupler bolts.*
12. Slowly raise the Z axis to the Limit Switch and check the number again. If within spec, tighten all coupling bolts to 18 ft. lbs. Home the machine. Go back to Service Code 505 and check once more. Check the gap between the coupler halves. Sec is .100." See figure 6.1.3.1c.

Warning!

Whenever the Z-axis motor is removed, service code 520 must be performed to re-establish Tool Locations and Z Tool Height.



Figure 6.1.3.1c

13. Enter service code 520 and press the "Input Table" tab to set Z tool change height.
 - a. Place a tool holder in any location. Jog the X and Y axes to the location coordinates that are displayed in the table.
 - b. Press the orient spindle tab.
 - c. Press the tool unclamp tab.
 - d. Using the EHW, highlight the Z Tool Change dialogue box.
 - e. Jog the Z-axis towards the tool holder, change to .002" resolution as you get close to the tool holder, then back up until the air just comes on. Note the Z tool change offset and add .01" that is displayed in the lower, right-hand gray box. Press ABS Set. (e.g. If the display reads -11.6500, after adding .01", the display should now read -11.6600.
 - f. Using Tool Loading, check all eight Tool Locations. Observe the action looking for unusual movement or noises. Re-adjust the locations if necessary. If needed, use a Co-axial Indicator and Tool Holder to "Sweep" in the locations.

6.1.4 AC Spindle Drive Replacement

DANGER!

The AC Drive uses 208 or 480 AC volts to operate, utilize care when working with these components. There is possibility of death by electrocution!

Service code 510 (reset orientation angle of the spindle) **must** be performed when an AC drive is replaced. Failure to do so will cause the spindle to orientate improperly and may lead to a crash.

1. Press the E-stop to disconnect power from the drive.
2. Turn the power off to the machine and wait 5 minutes for all power to discharge from the machine.
3. Open the electrical cabinet door.
4. Disconnect the main cable that runs from the spindle drive to the computer module.
5. Remove the front cover of the AC drive.
6. Remove and replace the wires that are used to hook up the spindle encoder. Please see drawing 29103-22 for correct wire placement. You will need to hook up these wires on the new AC drive.
Note – *Wires and spindle encoder connections are labeled at the factory.*
7. Remove the remaining 10 large wires. They are used to provide power to the drive, provide power from the drive to the spindle motor, dump the energy during braking to the braking resistors and provide grounds for the components.
8. Remove the AC drive from the machine, it is held in place with 4 screws. (**Note** - *Leave the lower screws loose in place to ease installation of the replacement AC Drive.*)
9. Follow these steps in reverse order install the replacement drive.

It should be noted that the replacement drive has already been programmed, but 1 parameter will need to be reset since it is unique for each machine. The parameter in question controls the orientation of the spindle.

1. Go to service code 510 and press the orientate spindle button. The offset should be displayed in the lower left-hand corner and must be added to the new AC drive which will allow tool changes to work correctly.

WARNING!

Failure to perform this step will cause the tool changer to crash and damage may occur.

2. Now go to the Yaskawa A1000 AC drive and enter this value under parameter P2-02. To do so, follow these steps.
 - a. Starting with "Freq Ref" screen and press Down Arrow twice until you hit the Programming Section. Press Enter which displays the Initialization Screen.
 - b. The Initialization Screen is used to enter data. Initialize the far-left field to "P2-02" with the up and down arrow keys to input the new spindle orientation position you just calculated. Use the right arrow key to move to the next position. If you go too far, the cursor will scroll back around the fields.
 - c. Now you will see the "Market Offset 1" screen displayed when you have entered "P2-02". Use the right arrow key to highlight the digits on the right-hand side of the "=" sign. Carefully enter the number you have calculated at the Pendant into this screen again

using the up and down arrows. (**Caution** - Entering the wrong number could damage mill and be a safety risk.)

- d. When you have confirmed the correct number is entered, press the "Enter" key. Now you back out of this screen by hitting the "Esc" key until you see the "Freq Ref (A1)" screen.
3. Lastly, go back to service code 510 and re-calibrate the spindle. Press the CAL RPM button and following the instructions on the screen.

6.1.5 Programming Panel, Run Panel and Computer Module Replacement

Note - The design of the VMC2 allows easy replacement of the programming and run panel assemblies. The sections below will provide instructions for Programming Panel, Run Panel, Hand Wheel, Key Lock, Emergency Knob, and Computer Module replacement if needed.

6.1.5.1 Programming Panel Replacement

1. Turn power off to the machine and control.
2. Remove all cover bolts on the rear of the pendant except the top two which allow support of the panel while you remove the remaining bolts. The holes are slotted so you can lift the panel with the top two bolts in place.
3. Disconnect the following cables as shown in figure 6.1.5.1 with red notes:
 - a. USB Ports (4) and Audio mounted on the metal pendant casing
 - b. DB25 Umbilical Cable Assembly
 - c. 4 ribbon cables from RUN PANEL to Programming panel overlay interface board
 - d. Both LAN Cable Assembly
 - e. E-stop Cable Wire Assembly
 - f. RSG connector remove screws from the bottom of medal pendant casing as shown in image.

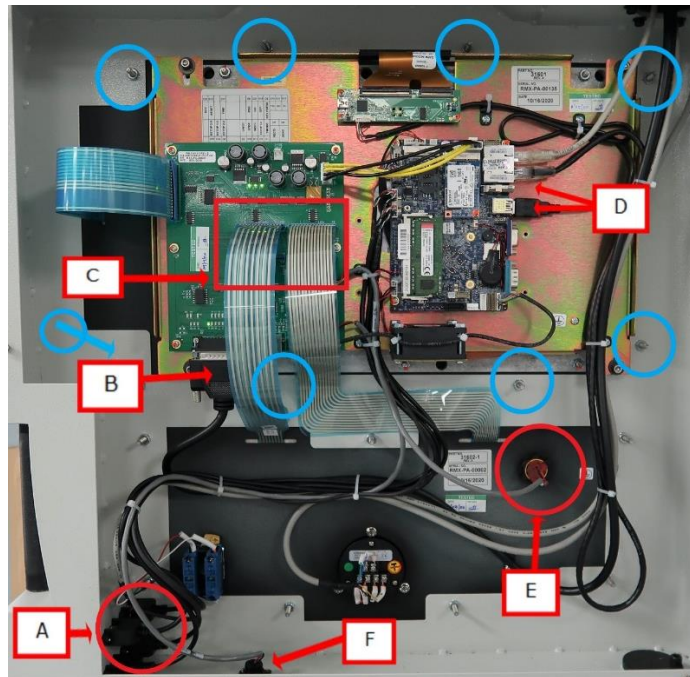

Figure 6.1.5.1 Panel Cabling

4. Support programming panel from the front and remove the 8 bolts from the programming panel perimeter and remove the panel from the front of the pendant as shown in figure 6.1.5.1 with blue circles.
5. Replace programming panel, replace the bolts and tighten just past finger tight, connect the data wires listed in step 3 and shown in figure 6.1.5.1. Replace rear cover and tighten bolts.
6. Power up the VMC2.
7. May need to update software, check Service Code 33. See section 4.4.1 Software Code Details.

6.1.5.2 Pendant Run Panel Replacement

1. Turn power off to the machine and control.
2. Loosen all cover bolts on the rear of the Pendant.
3. Remove all cover bolts except the top two which allow support of the panel while you remove the remaining bolts.
4. Four ribbon cables on the run panel are not field removable from the run panel so, carefully remove them from the programming panel end as shown on figure 6.1.5.2.
5. Disconnect the tape, tie downs, cables to the E-Stop switch, EHW, and key switch as shown in figure 6.1.5.2.
6. Support the run panel from the front and remove the seven bolts circled as shown in figure 6.1.5.2.

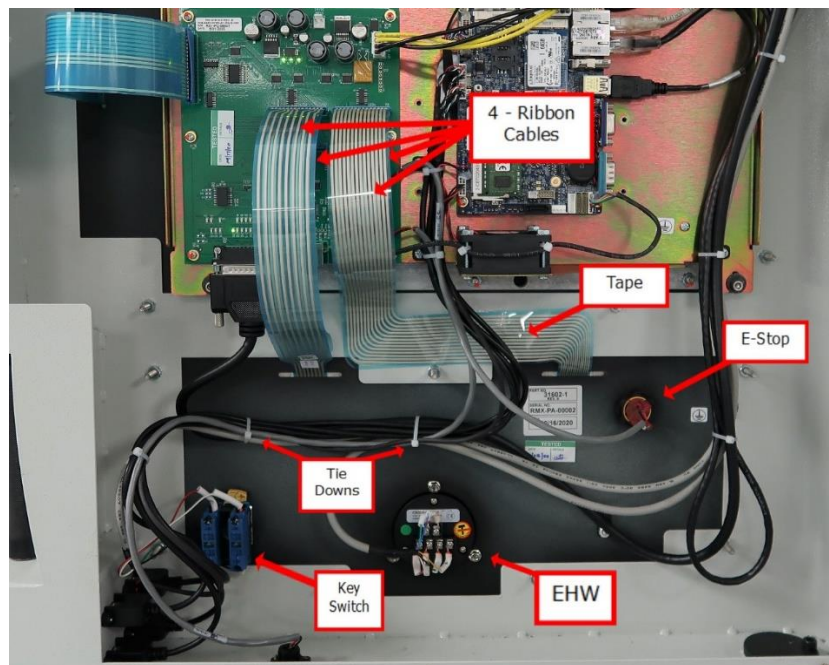

Figure 6.1.5.2

7. Replace run panel, replace the bolts and tighten just past finger tight, reconnect the data wires, ribbon cables, tie downs, tape, rear cover and tighten bolts.
8. Power up the VMC2

6.1.5.3 Pendant Hand Wheel, Key Lock Switch or Emergency Off Knob Replacement

1. Turn power off to the machine and control.
2. Remove the wires and hardware to the part being replaced as shown in figure 6.1.5.2.
3. Replace the part and reconnect hardware and wires.
4. Replace the rear cover and tighten bolts.
5. Power up the VMC2.

6.1.5.4 Computer Module Replacement

1. Turn power off to the machine and control. Disconnect VMC2 from power source.
2. Start with the power cord in the upper right-hand corner and unplug all the cables connected to the Computer Module as shown in figure 6.1.5.4.
3. Remove the Computer Module from the Electrical Cabinet by removing the 6 screws (circled in figure 6.1.5.4), 3 along the top and three along the bottom of the enclosure.

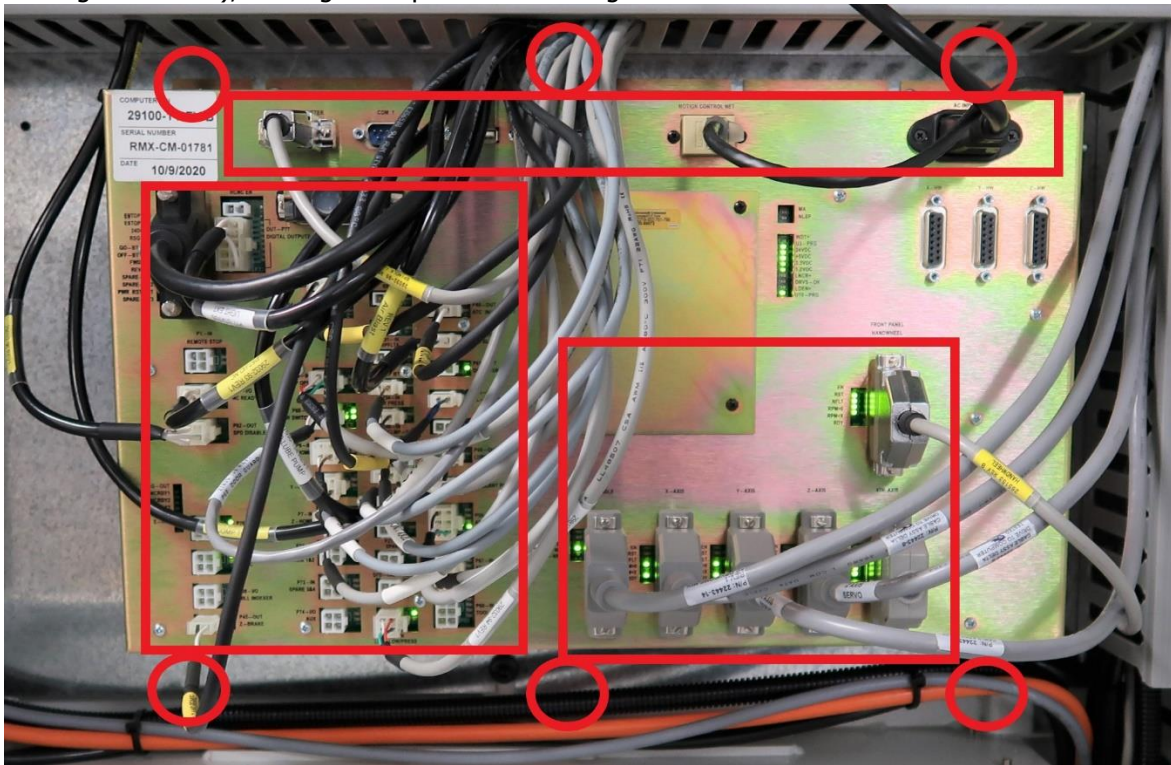

Figure 6.1.5.4 - Computer Module Replacement

4. Replace the Computer Module and reinstall.
5. Connect the cables to the Computer Module as shown in figure 6.1.5.4. Each cable is marked with its location on the enclosure, be sure to double check the correct wiring before attaching the power cord.
6. Attach the power cord to the computer module and power up the VMC2.
7. May need to update software, check Service Code 33. See section 4.4.1 Software Code Details.

6.1.5.5 VMC2 Computer Components

VMC2 Computer Components		
Item	P/N	Description
1	31601	VMC PROGRAMMING PANEL (In Pendant)
2	31602-1	VMC2 RUN PANEL (In Pendant)
3	29100-8	VMC2 COMPUTER MODULE (In Electric Box)

6.1.6 Updating the Pendant and CM Software

1. On the pendant, touch the "Status" soft key on the upper left portion of the touch screen. This will display the pendant and CM software version.
2. To verify the current software versions, go to <https://www.southwesternindustries.com/software>
 - a. Click on the "Current ProtoTRAK CNCs Software" tag. Find the RX section and refer to the software versions list.
3. To update to a more current version, first download the software from the website onto a USB Flash Drive.
4. Plug the USB Flash Drive into one of the pendant USB ports.
5. On the Pendant, select the soft key "Service Codes." Type in "316" and press the ABS Set key. Follow the instructions on the screen.

Note - Your configuration/calibration settings will not be changed by this procedure. If you wish to store your settings on a USB Flash drive, install a drive in one of the ports and use Service Code 142 to save the values. Service Code 141 can be used to restore the values on your Flash Drive back onto the pendant.

6.1.7 Adding Solid State Drive (SSD) Memory Option

TRAK provides an option for the VMC2 that allows customers access to a large amount of disk storage space for their custom programs specific to their business. This provides an archive of production programs in the Pendant readily accessible for operations and reduce the need to transfer programs from other storage devices.

1. Power down the VMC2. Pendant rear cover must be removed. Use caution, this is a heavy cover. There are slots for each bolt that allow the technician to loosen the upper bolts to support the weight of the cover while the remaining bolts are loosened and removed. The Pendant circuit board is Part #31601.
2. Memory kit includes the needed hardware for this installation:

Part Number	Quantity	Description
31616	1	Bracket
31625	1	Programmed 2.5" SSD Memory Card
6-32X¼ X1¼	4	Standoff- HEX Male/Female Aluminum
6-32x¼	4	Screw PH Phil EXT SEMS STL BO
Small	4	Screws to attach Memory card to bracket

3. Use the four standoff studs and place them in the threaded holes that match the pattern for the memory bracket as shown in Figure 6.1.7a. These do not need to be very tight, just firm. Align the bracket on the four standoffs and use the supplied screws and tighten just past finger tight.

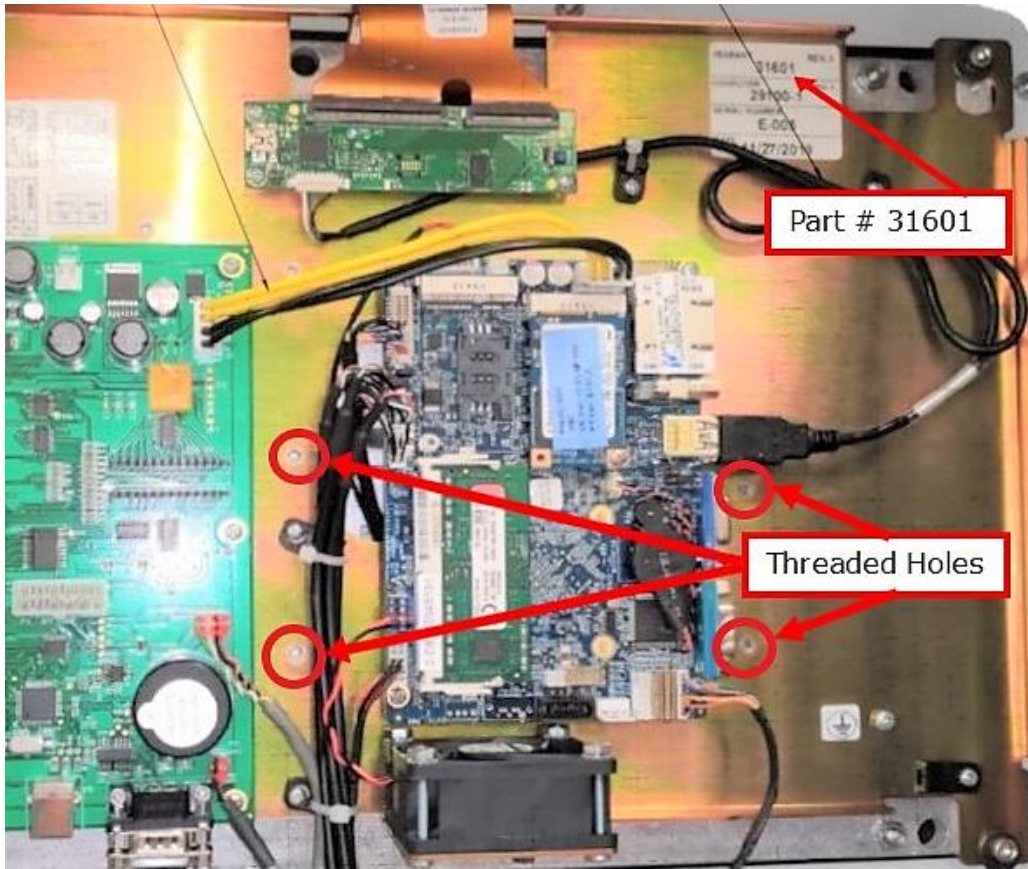

Figure 6.1.7a

4. The SSD needs to be installed on the bracket with the four small screws provided from the rear of the bracket into the memory card. The bracket is then installed on the four standoffs with screws provided. Figure 6.1.7b shows the bracket installed and where to locate the memory card.



Figure 6.1.7b

5. Install Cable on SSD card which consists of either two separate cables (power and data) or one cable with two wires attached. Each cable has a notch on the connector that only permits the cable to be installed one way due to the matching notch on the SSD and the sizes of the wires as shown in Figure 6.1.7c.

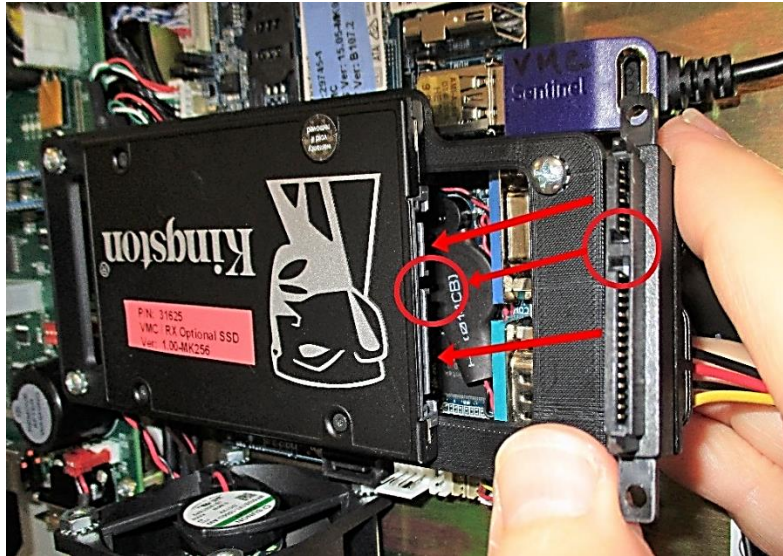

Figure 6.1.7c

6. The SSD cable branches into a data and power cables to be connected into the circuit board behind and below the SSD just installed. The data cable terminates with same type of notch as used in the large end preventing an error while attaching the connector. The smaller white power connector has a wide notch with a tab along the bottom which forces the install only one way as shown in Figure 6.1.7d.

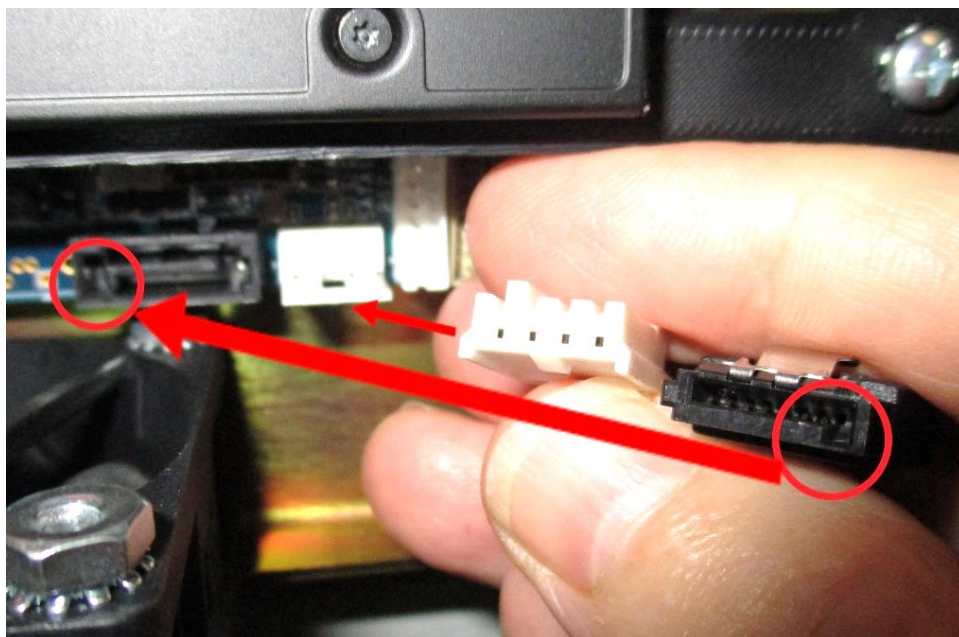

Figure 6.1.7d

7. Make sure the cable is safe the way it is routed from the SSD card to the circuit board connections. The cable should be loose and not bound on a metal corner, cover or another object. Reattach the cover and firm the bolts. They do not need to be very tight. Power up the VMC2 and test the installation by inserting a removable USB drive into either USB port inside an alcove along the right edge of the pendant. Copy from the removable USB (Usually Drive E) to the new SSD memory (Drive D) to make sure the new SSD is working by sliding the Programming screen at the lower right corner to open the keyboard pop up. Press the Windows key on the lower left-hand corner of the keyboard to bring up Windows Menu. Select Devices & Printers and the Device Display lists the USB. Copy a test file from the USB to drive D the new SSD.

6.1.8 Cable Routing on Machine

Whenever you replace or reroute a cable it is very important to keep the power cables and logic cables separated from each other. The power cables consist of the (3) 208-volt motor cables and (2) 208-volt power cables for the Computer Module and a coolant pump or lube pump cable. The logic cables are used to carry encoder signals between the servos and computer module. Mixing of the power and logic cables may cause noise from the power cables to interrupt the signals in the logic cables. This can lead to intermittent axis faults or repeatability problems.

6.1.9 Maintenance

6.1.9.1 How to Clean the Touchscreen

When cleaning the touchscreen, make sure to turn off the machine. You can use any window cleaning solution to get any debris off of the screen. It is preferable to use a non-lint cloth when cleaning.

Note - *If you clean the screen with the power on, you may get false triggering or no touchscreen detection at all.*

6.1.9.2 Periodic Maintenance

The following table lists the periodic maintenance that must be done on a daily, weekly, month(s) and yearly basis. Contact TRAK to set up on site maintenance for your VMC2 and other TRAK Products.

See section 2.13 for more information on lubrication related checks.

Maintenance Time Period	Items
Daily	<ol style="list-style-type: none"> 1. Drain the water from the air regulator assembly by either turning off the air to the machine or depressing the valve at the bottom of the water collector tank. 2. Check to make sure there are no obvious oil leaks to the lubrication system. 3. Check coolant level.
Weekly	<ol style="list-style-type: none"> 1. Check the level of the lubrication pump. 2. Check the oil level in the oiler that supplies oil to the pneumatic components.
Monthly	<ol style="list-style-type: none"> 1. Check the oil level of the Tool Change Air Cylinder Oil Cup, which is found under the sheet metal that surrounds the head. You can view this oil cup when the sheet metal is on by looking down from above. 2. Every few months we recommend you remove the coolant tank and clean all debris and replace the coolant. 3. Remove the air filters in the electrical cabinet every few months and clean. 4. Check the level and tram of the machine every 6 months and adjust as necessary. 5. Check the spindle motor belt tension every 6 months.
Annually	<ol style="list-style-type: none"> 1. Check backlash on each axis and adjust as necessary. 2. Remove all covers and clean chips and debris that may have built up. 3. Inspect the ATC by removing the covers 4. Inspect the tool change air cylinder 5. Apply grease to the grease fittings on the ATC unit.

6.1.10 Calibration

6.1.10.1 Introduction

Your VMC2 is set up at the factory to give excellent accuracy and repeatability. Calibration can be checked or redone but is usually not needed unless there was a major problem in production.

6.1.10.2 Set Up Calibration Test

Calibration & Backlash Constants

Calibration and backlash constants were set as part of the installation and set-up of your system. They should be re-set when indicated in the Troubleshooting section or after the replacement of the Computer module, or any parts of the drive train.

X, Y, Z Calibration

Calibration is used teach the machine a known distance. We typically calibrate our machines over a 150 mm distance. There is no limit to how far you can calibrate the machine.

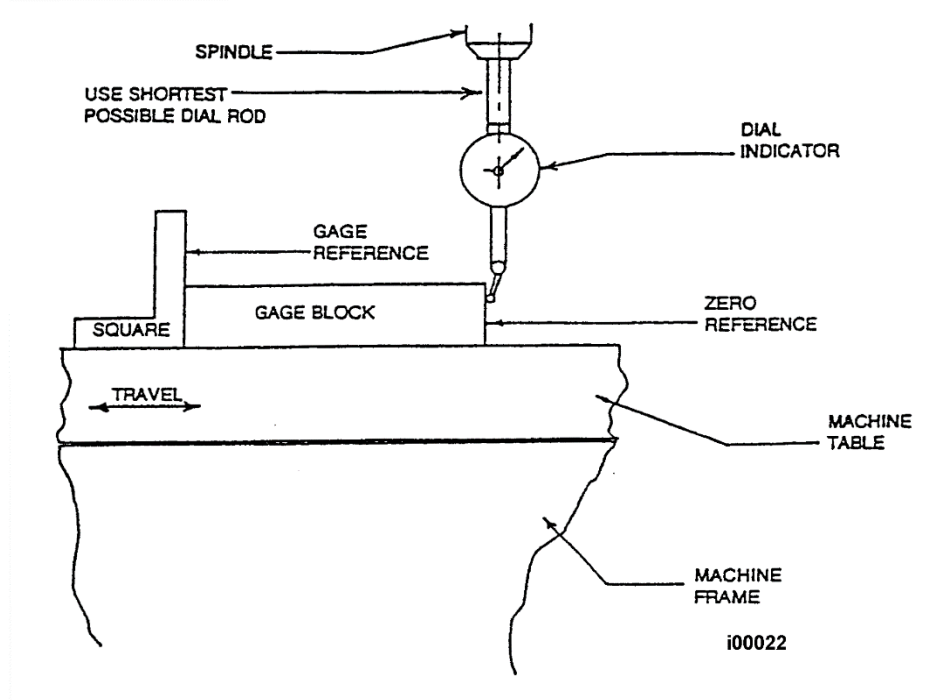

Figure 6.1.10.2a - Calibration Set Up

1. Set-up a gauge block or standard and indicate it parallel to the axis you are calibrating see figure 6.1.10.2a. (**Note** - Put the display in Inch or mm to match your gage block.)
 - a. Recommended gage blocks are: X, Y and Z -- 150mm or 6"
2. Set a 0.0001" indicator in the spindle and move it up to one side of the gage block or standard.
3. Go to setup mode, go to section "B" and press CODE 123 see figure 6.1.10.2b.
4. Select the axis you want to calibrate X, Y or Z.
5. Follow the instructions on the screen to complete calibration.

From the main ProtoTRAK screen, go into SETUP, SERV CODES, CODE #, then type in 123 and press ABS SET. This will bring up the calibration page.

Press "LOAD DEFAULT" then select "X" from bottom row of buttons. Load Calibrate VMC2 Program and set Z Retract to ABSET, check positional accuracy (0.0005" max). Sample Service Code 123 screen shown in figure 6.1.10.2b. Follow the on-screen instructions to complete the calibration.

INFO	Code 123: Axis Calibration	MODES
STATUS	X AXIS MOTOR CALIBRATION: 0.000236 in STD LENGTH: 5.905512 in	DRO
TOOL TABLE	Y AXIS MOTOR CALIBRATION: -0.000236 in STD LENGTH: 5.905512 in	PROG
EPA	Z AXIS CALIBRATION: -0.000059 in STD LENGTH: 2.952756 in	EDIT
MATH HELP		SET-UP
		RUN
DEFAULTS		PROG IN/OUT
KEY BOARD		
CALC		
	Please Select Axis X, Y or Z	
LOAD DEFAULT		MM
		RETURN

Figure 6.1.10.2b

6.1.11 Auto Tool Changer Maintenance

Tool changer may become erratic over time and cause problems with mill operation. Problems could be due to contaminants in the air system such as water or dirt. Proper ATC operation depends on a constant air supply at the required pressure. After any air problems are resolved adjusting the air flow control may restore proper operation. It is recommended to do an ATC Cylinder Initial Adjustment first and then proceed with the ATC Door Assist Cylinder Initial Adjustment.

6.1.11.1 ATC Cylinder Initial Adjustments

- **Front Flow Control Adjustment** (labeled 2 on drawing 27563-1) - Commonly known as "meter-out" type, it controls the air exhausting from the cylinder, it is used to adjust the speed of the ATC cylinder as it extends toward the work table.
- **Initial Adjustment** - Close the flow control all the way**, mark the knob with a black marker to establish a reference starting point, and then open it 10 full turns.
- **Front Internal Cushion Adjustment** - This air cushion controls the deceleration of the cylinder when it is within the last 1.5 inches of its full extension. It causes the cylinder to slow down gradually near the end of the extend stroke. See figure 6.1.11.1a.
- **Initial Adjustment** - Using a 3mm Allen wrench close the cushion all the way down, and open it 1/2 of a turn.
- **Rear Flow Control** (Mounted on the exhaust port of the quick exhaust valve, labeled 1 on drawing 27563-1) - This "metering-out" type flow control is used to control the speed of the ATC cylinder as it retracts back to its home position.
- **Initial Adjustment** - Close the flow control all the way, mark the knob with a black marker to establish a reference starting point, and then open it 1 1/2 turns.

- **Rear Internal Cushion Adjustment** - This air cushion controls the deceleration of the cylinder when it is within the last 1.5 inches of the full retraction. It causes the cylinder to slow down gradually near the end of the retract stroke.
- **Initial Adjustment** - Close the cushion all the way down, and open it 1/4 turn. Figure 6.1.11.1 shows both cushions on the ATC cylinder.

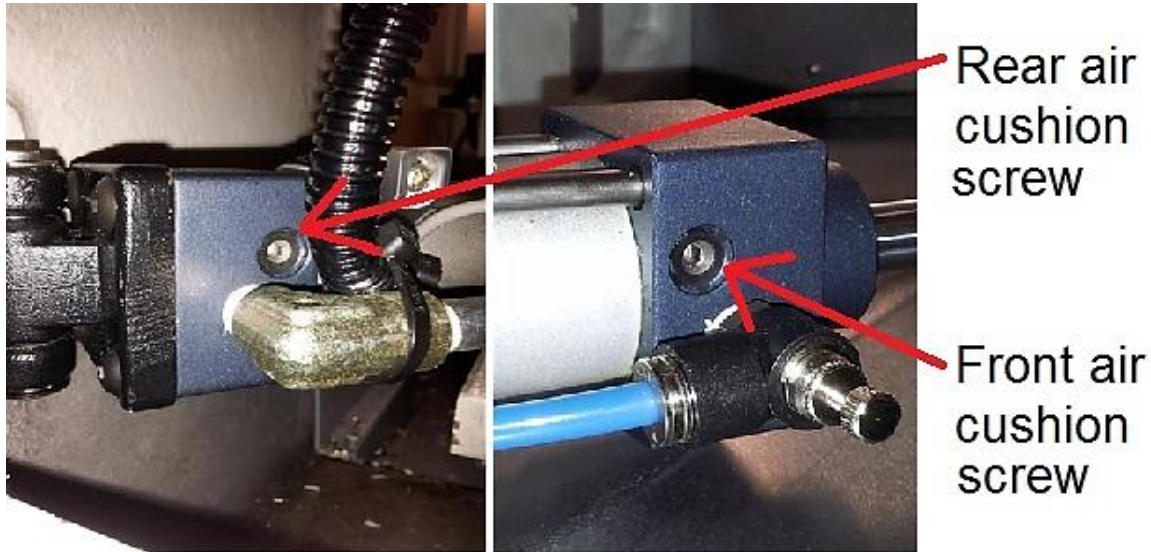

Figure 6.1.11.1

6.1.11.2 ATC Door Assist Cylinder Initial Adjustments

Door Opening

- **Front Flow Control** - This flow control is a "metering-out" type (labeled 6 on drawing 27563-1), it controls the air exhausting from the front of the cylinder, it is used to adjust the speed of the door cylinder as it extends and lifts the door up.
- **Initial Adjustment** - Close the flow control all the way**, mark the knob with a black marker to establish a reference starting point, and then open it 1 3/4 full turns.

Door Closing

Rear Flow Control - This flow control is a "metering-out" type (labeled 4 on Sheet 2 of drawing 27563-1), it controls the air exhausting from the back of the cylinder, it is used to adjust the speed of the door cylinder as it retracts and closes the door.*

***In order to close the door in a relatively controlled manner, a second flow control for controlling the air going into the cylinder is used; this flow control is commonly known as a "metering -in" type (labeled 5 on drawing 27563-1).*

- **Initial Adjustment** - Close the flow control all the way**, mark the knob with a black marker to establish a reference starting point, and then open it 1 1/2 full turns.
- **Initial Adjustment** - Close the flow control all the way**, mark the knob with a black marker to establish a reference starting point, then open it 1 1/2 full turns.
***When closing flow controls used on this machine you will not feel a hard stop when the flow control is completely closed, but you will feel a noticeable change in tightening resistance as you approach the closed position, please use reasonable care and do not over tighten them.*

7.0 Introduction to Self-Service

The objective of this section of the manual is to allow the user of the ProtoTRAK Control to resolve the majority of potential service problems.

This manual assumes that the user is not experienced with CNC troubleshooting and repairs. Special tools are not required for the procedures described in the manual.

Please see Section 3 for basic troubleshooting sections of the manual.

7.1 When You Have a Service Problem

SWI recommends that you consult this manual or our web site first. We also have a Dozuki site with detailed troubleshooting procedures <https://trakmtsupport.dozuki.com/>. Often it will be possible for you to resolve the problem yourself or isolate the problem to a particular cause.

Your next step is to contact the TRAK Customer Service Group for assistance.

7.1.1 Communication with the SWI Customer Service Group

TRAK Service Department Direct Line: (800) 367-3165

Web Address: www.trakmt.com

This phone line rings directly into the TRAK Customer Service Group. If a Customer Service Representative (CSR) is not available within the first few of minutes, your call is transferred into our voice mail system.

Our voice mail is continuously monitored. If you have an emergency, indicate this in your message. Our Service Voice Mail box number is 555.

TRAK Service Department Direct Fax Number: (310) 886-8029

Customer Service Group Hours: Monday - Friday 7:00 AM to 4:30 PM (PCT)
(TRAK observes a normal holiday schedule.)

7.2 Replacements

7.2.1 Exchange Program

SWI keeps in stock the major subassemblies required to resolve service problems. With very few exceptions, the part needed to resolve any given service problem is on the shelf and ready to ship. A little bit of troubleshooting on your part means that we can get the right part to you fast.

After replacing the failed unit with the replacement unit, simply put the failed unit in the same box that the replacement part came in and ship it back to us via UPS ground service.

This unique Exchange program gives our customers access to refurbished "like-new" subassemblies that have been brought up to current design revisions and go through the same QC procedures as our new products. These high-quality replacement units are available at a fraction of the price of a new subassembly.

7.2.2 Return Material Authorization (RMA) Number

All shipments of replacement parts are accomplished through our Return Material Authorization (RMA) system. At the same time the CSR is diagnosing the problem and ordering the part, they will issue an RMA number that will allow us to efficiently process the return part.

8.0 Appendix

8.1 Pneumatic System Drawing – 27563-1

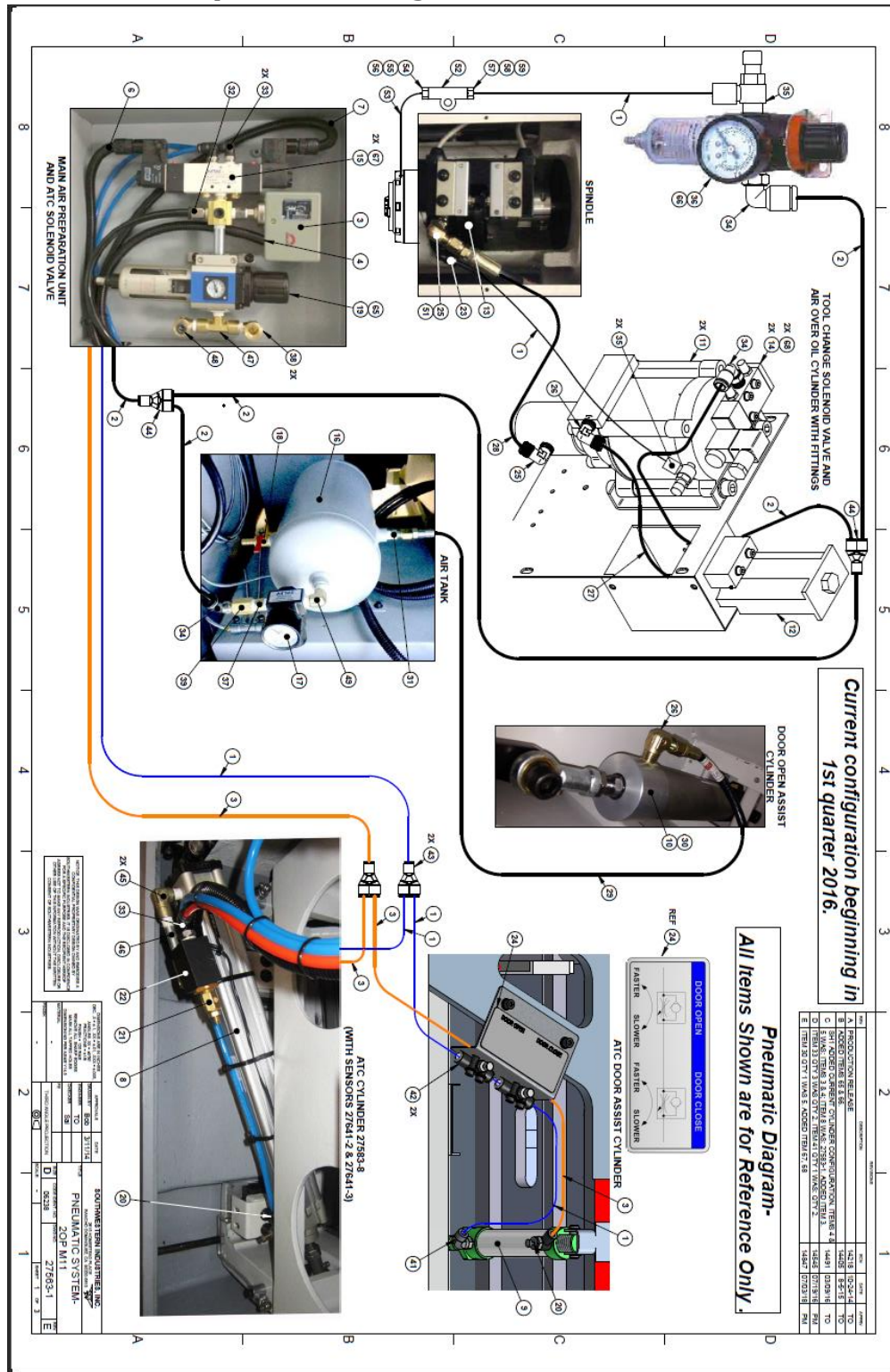

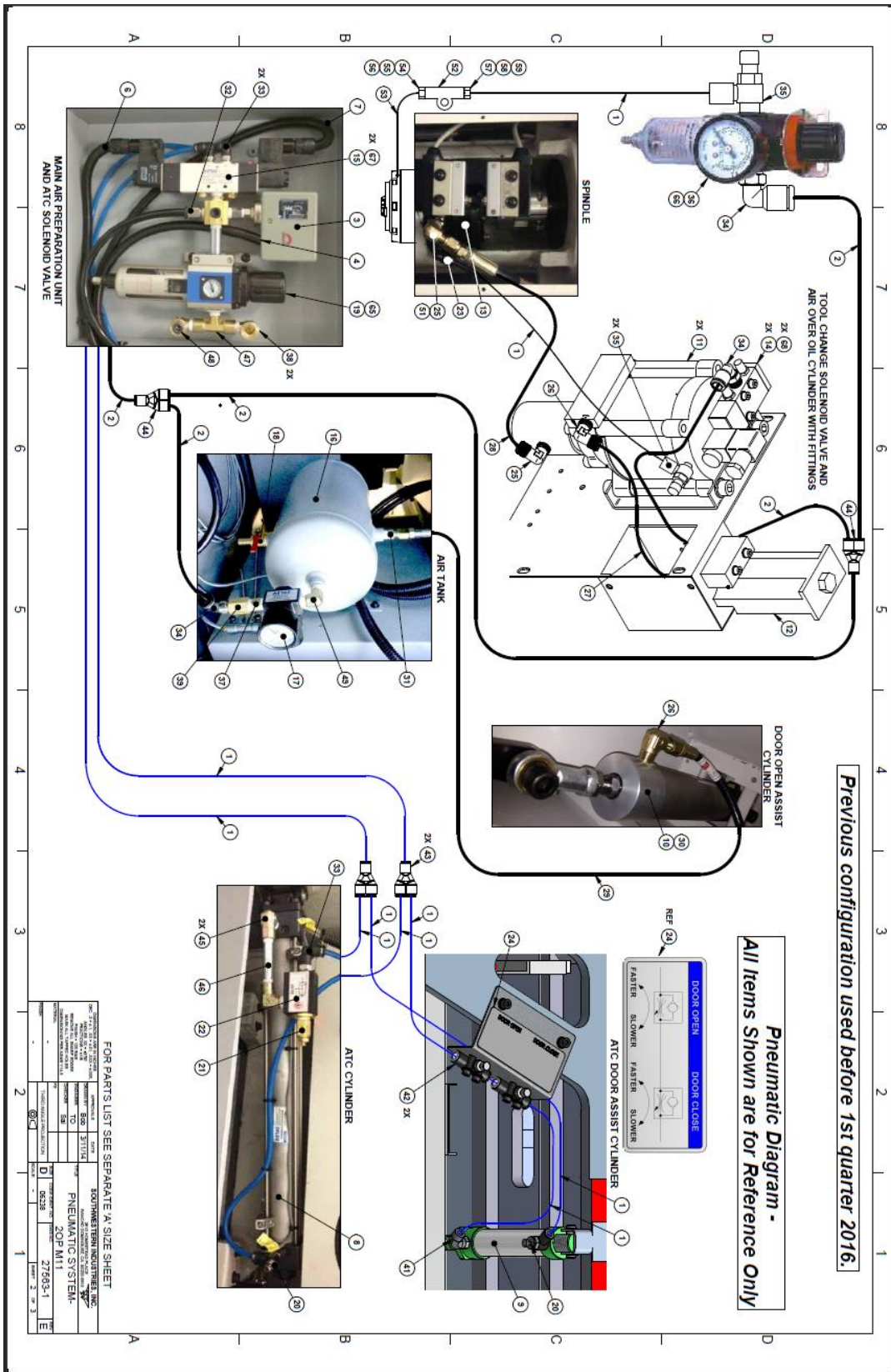

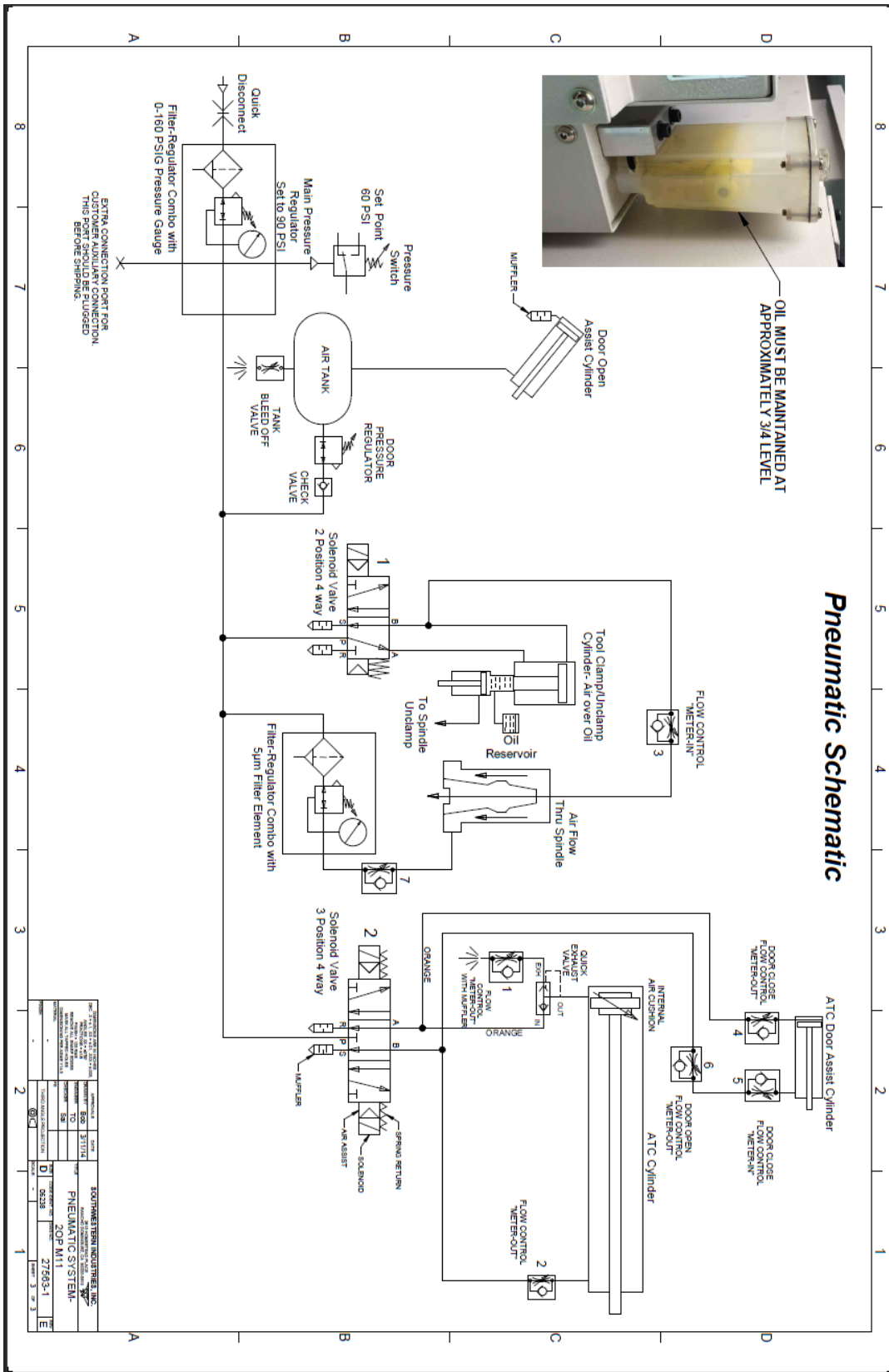

Parts List for Assembly P/N: 27563-1

Printed 7/3/2018

27563-1
PNEUMATIC SYSTEM-2OP M11

Type	PL	Dwg Size	D
Revision	E	Product	PT8
Status	R	Engineer	TO
Date	2/27/2014	Planner Code	
By	Bob	Comm Code	

Item	P/N	Title	Detail	Reference/t	Qty	UseAs	Rev	Stat	Type	Mfr	Mfr P/N
1	27531	TUBING-POLYURETHANE-6mm OD-BLUE			A/R	IN	-	R	PS	KING RICH	
2	27531-1	TUBING-POLYURETHANE-10mm OD			A/R	IN	-	R	PS	KING RICH	
3	27531-2	TUBING-POLYURETHANE-6mm OD-ORANGE			A/R	IN	A	R	PS	KING RICH	
4	26931-1	SWITCH-AIR PRESSURE			(1)	EA	-	R	PS	KING RICH	
5	27635-5	CABLE ASSY-LIMIT SW-AIR PRESSURE	DC300-110		(1)	EA	-	R	PL		
6	27635-11	CABLE ASSY-SOLENOID ATC BACK	DC300-108		(1)	EA	A	R	PL		
7	27635-12	CABLE ASSY-SOLENOID ATC FRONT	DC300-109		(1)	EA	A	R	PL		
8	27583-8	CYLINDER-AIR-32 BORE 300 STROKE	USED WITH SENSORS ASSY 27641-2 & 27641-3		(1)	EA	A	R	DWG		
9	27583-5	CYLINDER-AIR-20mm BORE X 60mm STROKE			(1)	EA	A	R	DWG		
10	27583-6	CYLINDER-AIR-40mm BORE 125mm STROKE			(1)	EA	-	R	DWG		
11	27670-1	CYLINDER-TOOL UNCLAMP	SEE 27502-3		(1)	EA	A	R	DWG		
12	27502-2	RESERVOIR-OIL MAKEUP-TOOL UNCLAMP CYLINDER	SEE 27563-1		(1)	EA	A	R	PS	KING RICH	A-222-007
13	27830	SPINDLE ASSY-2OP M10 MILL			(1)	EA	D	R	PL		
14	26938-6	VALVE-AIR-SOLENOID-SINGLE-4WAY-2POS-24VDC			(1)	EA	A	R	DWG		
15	26938-5	VALVE-AIR-SOLENOID-DOUBLE-4WAY-3POS-NO-24VDC			(1)	EA	-	R	DWG		
16	28033	AIR TANK			(1)	EA	-	R	DWG		
17	28034	AIR REGULATOR	SEE 27563		(1)	EA	-	R	PS		

SOUTHWESTERN INDUSTRIES, INC.
2615 HOMESTEAD PLACE, RANCHO DOMINGUEZ, CA. 90220
1-310-608-4422 Fax 1-310-764-2668

Parts List for Assembly P/N: 27563-1
 PNEUMATIC SYSTEM-ZOP M11

27563-1
 Rev E
 Printed 7/3/2018

Item	P/N	Title	Detail	Reference	Qty	UseAs	Rev	Stat	Type	Mfr	Mfr P/N
18	28035	DRAIN VALVE - AIR TANK	SEE 27563		(1)	EA	-	R	PS	KING RICH	
19	22607-2	FILTER/REGULATOR-W/ 40µm FILTER, 0-160 PSI	FOR FILTER REPL SEE 24607-4		(1)	EA	C	R	DWG		
20	28071	VALVE-FLOW CONTROL-AIR			(2)	EA	-	R	PS	KING RICH	A-572-001
21	28071-1	VALVE-FLOW CONTROL W/MUFFLER-AIR	SEE 27563		(1)	EA	-	R	PS	KING RICH	A-260-007-3
22	28074	VALVE-QUICK EXHAUST	SEE 27563		(1)	EA	-	R	PS	KING RICH	A-201-001
23	27016-1	FITTING-QUICK CONNECT 6MM TO 1/8 BSPT			(1)	EA	A	R	DWG		
24	27694-21	LABEL-FLOW CONTROL VALVES	(S-S1260)		(1)	EA	A	R	DWG		
25	27076-2	FITTING-90°-1/4 HYDR SWVL TO 1/4 HYDR FM			(2)	EA	-	R	PS	KING RICH	A-316-012
26	26952-3	FITTING-AIR-90°-1/4 BSPTx1/4 HYDR MM	SEE 27563		(2)	EA	-	R	PS	KING RICH	A-316-012
27	28127-4	LINE-HYDRAULIC-1/4 X 220mm			(1)	EA	A	R	DWG	KING RICH	A-316-611-1
28	28127-1	LINE-HYDRAULIC-1/4 X 450mm			(1)	EA	A	R	DWG		
29	28127-3	LINE-HYDRAULIC-1/8 X2850mm			(1)	EA	A	R	DWG		
30	27574	MUFFLER-1/4 BSPT			(1)	EA	-	R	PS	KING RICH	A-316-136
31	27091-3	FITTING-STRAIGHT-1/4 BSPT X 1/4 HYDR MM	SEE 27563		(1)	EA	-	R	PS	KING RICH	
32	27091-2	FITTING-AIR-STRAIGHT-10mm-PUSH TO CONNECT	1/4 BSPT MALE THD		(1)	EA	-	R	PS	KING RICH	
33	27085-1	FITTING-AIR-90°-6mm-PUSH TO CONNECT	1/4 BSPT MALE THD		(3)	EA	-	R	PS	KING RICH	A-316-408
34	27085-2	FITTING-AIR-90°-10mm-PUSH TO CONN-1/4 BSPT M	SEE 27542 OR 27563		(3)	EA	-	R	PS	KING RICH	A-316-381
35	28071-2	VALVE-FLOW CONTROL-AIR	1/4 BSPT TO 6mm PUSH TO CONNECT		(1)	EA	-	R	PS	KING RICH	JSC0603
36	22607-5	FILTER/REGULATOR-W/ 5µm FILTER,0-140 PSI	FOR FILTER REPL SEE 24607-6		(1)	EA	B	R	DWG		
37	27725	CHECK VALVE-STRAIGHT-1/4 BSPT	SEE 27563		(1)	EA	-	R	PS	KING RICH	

SOUTHWESTERN INDUSTRIES, INC.
 2615 HOMESTEAD PLACE, RANCHO DOMINGUEZ, CA. 90220
 1-310-608-4422 Fax 1-310-764-2668

27563-1
 Page 2 of 4

Parts List for Assembly P/N: 27563-1
 PNEUMATIC SYSTEM-ZOP M11

27563-1
 Rev E
 Printed 7/3/2018

Item	P/N	Title	Detail	Reference	Qty	UseAs	Rev	Stat	Type	Mfr	Mfr P/N
38	26952-2	ELBOW-STREET-1/4 BSPT	SEE 27563		(2)	EA	-	R	PS	KING RICH	
39	27745	COUPLING-1/4 BSPT	SEE 27563		(1)	EA	-	R	PS	KING RICH	
41	24673-2	ELBOW-1/8 BSPT TO 6mm QUICK CONNECT			(1)	EA	-	R	PS		
42	28071-3	VALVE-FLOW CONTROL-INLINE-AIR	Ø6mm PUSH TO CONNECT		(2)	EA	-	R	PS	KING RICH	A-260-070
43	27745-1	COUPLING-Y-6mm PUSH TO CONNECT	SEE 27563		(2)	EA	-	R	PS	KING RICH	
44	27745-2	COUPLING-Y-10mm PUSH TO CONNECT	SEE 27563		(2)	EA	-	R	PS	KING RICH	
45	24673-1	ELBOW-STREET - 1/8 BSPT	SEE 27540 OR 27540-1		(2)	EA	-	R	PS		
46	28076	NIPPLE-ROUND- 1/8 BSPT X 2 LG	SEE 27540 OR 27540-1		(1)	EA	-	R	PS		
47	22169-4	FITTING-PIPE-TEE-F/M/F-1/4 BSPT	SEE 27542 OR 27563		(1)	EA	-	R	PS	KING RICH	
48	28042-3	PLUG-1/4 BSPT	SEE 27563		(1)	EA	-	R	PS	KING RICH	
49	26952-4	FITTING-AIR-90°-1/4 BSPT MM	SEE 27542 OR 27563		(1)	EA	-	R	PS	KING RICH	
51	27076-1	FITTING-STRAIGHT-1/8 BSPT TO 1/4 HYDR MM	SEE 27563		(1)	EA	-	R	PS	KING RICH	
52	27745-3	COUPLING-1/4 BSPT	SEE 27563-1		(1)	EA	-	R	PS	KING RICH	
53	A4	TUBING-4MM ALUM				A/R	-	R	PS	CHIBA	
54	28046	NUT-COMPRESSION-4mm-MANIFOLD			(1)	EA	-	R	PS	KING RICH	
55	28047	SLEEVE-COMPRESSION-OUTER-4mm-MANIFOLD			(1)	EA	-	R	PS	KING RICH	
56	28047-1	SLEEVE-COMPRESSION-INNER-4mm-MANIFOLD			(1)	EA	-	R	PS	KING RICH	
57	28046-2	NUT-COMPRESSION-6mm-MANIFOLD			(1)	EA	-	R	PS	KING RICH	
58	28047-2	SLEEVE-COMPRESSION-OUTER-6mm-MANIFOLD			(1)	EA	-	R	PS	KING RICH	
59	28047-3	SLEEVE-COMPRESSION-INNER-6mm-MANIFOLD			(1)	EA	-	R	PS	KING RICH	
65	22607-4	FILTER ELEMENT-REPLACEMENT	SEE 22607-2		(1)	EA	-	R	PS	KING RICH	A-260-051

SOUTHWESTERN INDUSTRIES, INC.
 2615 HOMESTEAD PLACE, RANCHO DOMINGUEZ, CA. 90220
 1-310-608-4422 Fax 1-310-764-2668

27563-1
 Page 3 of 4

Parts List for Assembly P/N: 27563-1
 PNEUMATIC SYSTEM-2OP M11

27563-1
 Rev E
 Printed 7/3/2018

Item	P/N	Title	Detail	Reference(s)	Qty	UseAs	Rev	Stat	Type	Mfr	Mfr P/N
66	22607-6	FILTER ELEMENT-REPLACEMENT	SEE 22607-5		(1)	EA	A	R	DWG		
67	27574-1	MUFFLER-1/8 BSPT			(2)	EA	A	R	PS	KING RICH	A-316-136
68	27574-2	MUFFLER-3/8 BSPT			(2)	EA	A	R	PS	KING RICH	A-316-136

SOUTHWESTERN INDUSTRIES, INC.
 2615 HOMESTEAD PLACE, RANCHO DOMINGUEZ, CA. 90220
 1-310-608-4422 Fax 1-310-764-2668

27563-1
 Page 4 of 4

8.2

Electrical Enclosure Assembly Drawing – 29103-22

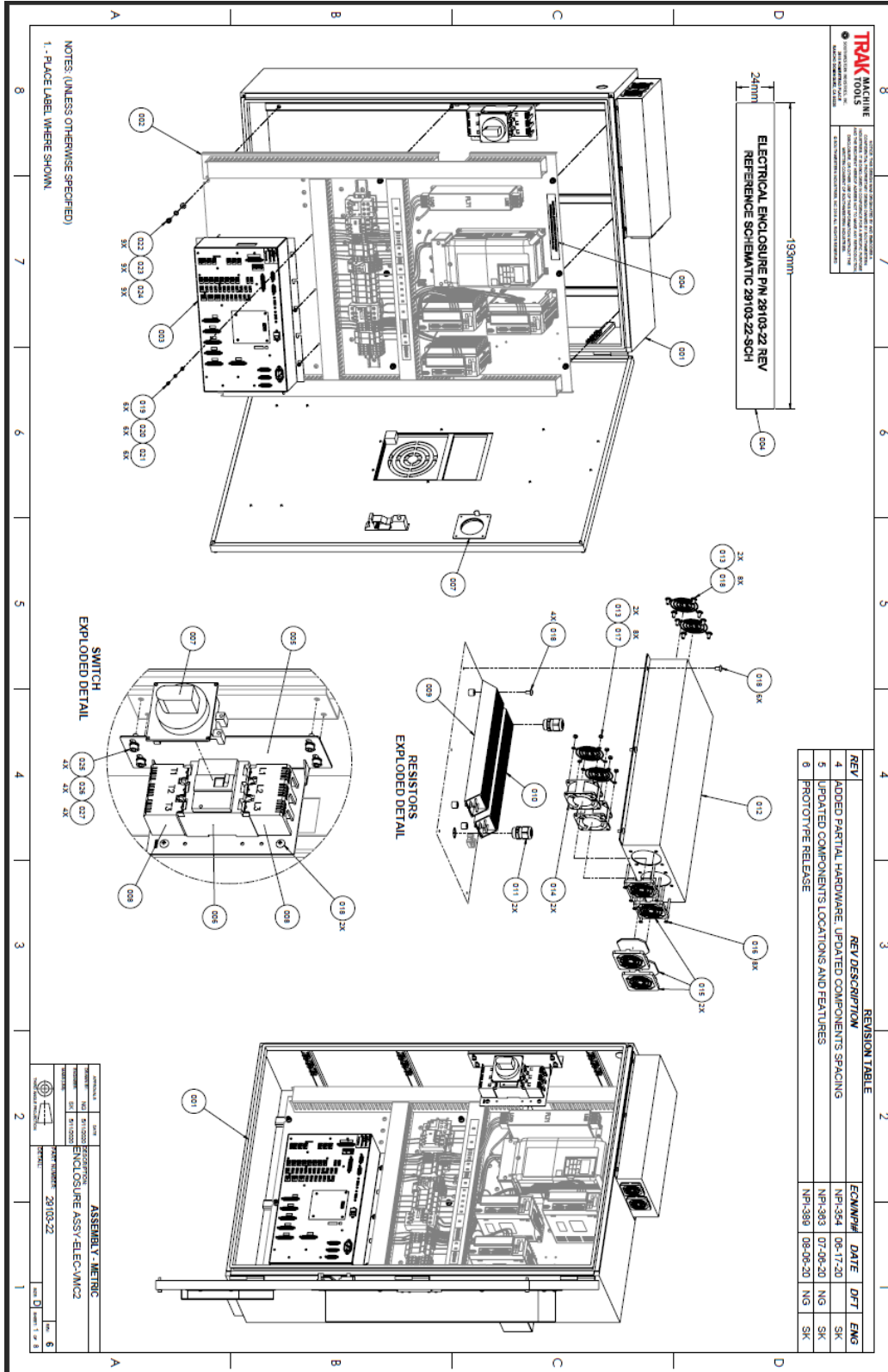

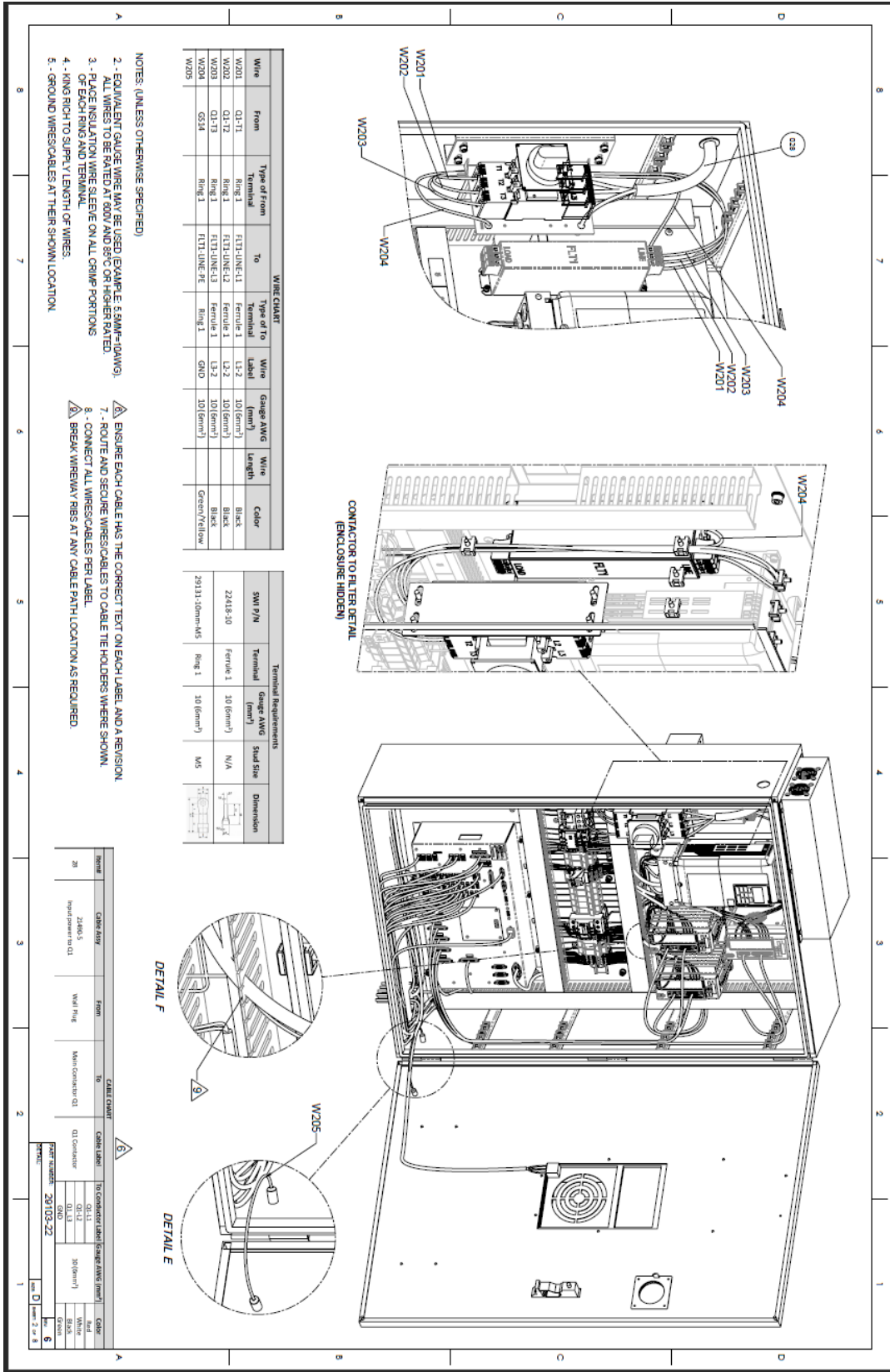

WIRE CHART

Wire	From Terminal	Type of From Terminal	To Terminal	Type of To Terminal	Wire Label	Gauge/AWG (mm ²)	Wire Length	Color
W201	Q1-T1	Ring 1	F11-LINE-L1	Ferrule 1	L3-2	10 (6mm ²)		Black
W202	Q1-T2	Ring 1	F11-LINE-L2	Ferrule 1	L3-2	10 (6mm ²)		Black
W203	Q1-T3	Ring 1	F11-LINE-L3	Ferrule 1	L3-2	10 (6mm ²)		Black
W204	GS14	Ring 1	F11-LINE-PE	Ferrule 1	GN0	10 (6mm ²)		Green/Yellow
W205								

Terminal Requirements

SWI P/N	Terminal	Gauge/AWG (mm ²)	Stud Size	Dimension
22418-10	Ferrule 1	10 (6mm ²)	N/A	
29131-10mmxM5	Ring 1	10 (6mm ²)	M5	

- NOTES: (UNLESS OTHERWISE SPECIFIED)
- EQUIVALENT GAUGE WIRE MAY BE USED (EXAMPLE: 4.5MM²-14AWG).
 - ALL WIRES TO BE RATED AT 90°C AND 85°C OR HIGHER RATED.
 - PLACE INSULATION WIRE SLEEVE ON ALL CRIMP PORTIONS OF EACH RING AND TERMINAL.
 - RING RICH TO SUPPLY LENGTH OF WIRES.
 - GROUND WIRE/SPECIES AT THEIR SHOWN LOCATION.

- ENSURE EACH CABLE HAS THE CORRECT TEXT ON EACH LABEL AND A REVISION.
- ROUTE AND SECURE WIRE/SPECIES TO CABLE TIE HOLDERS WHERE SHOWN.
- CONNECT ALL WIRE/SPECIES PER LABEL.
- BREAK WHENEVER RIS AT ANY CABLE PATH LOCATION AS REQUIRED.

CABLE CHART

From	To	Cable Label	From	To	Cable Label	From	To	Cable Label
28465	28465	28465	28465	28465	28465	28465	28465	28465
29103-22	29103-22	29103-22	29103-22	29103-22	29103-22	29103-22	29103-22	29103-22

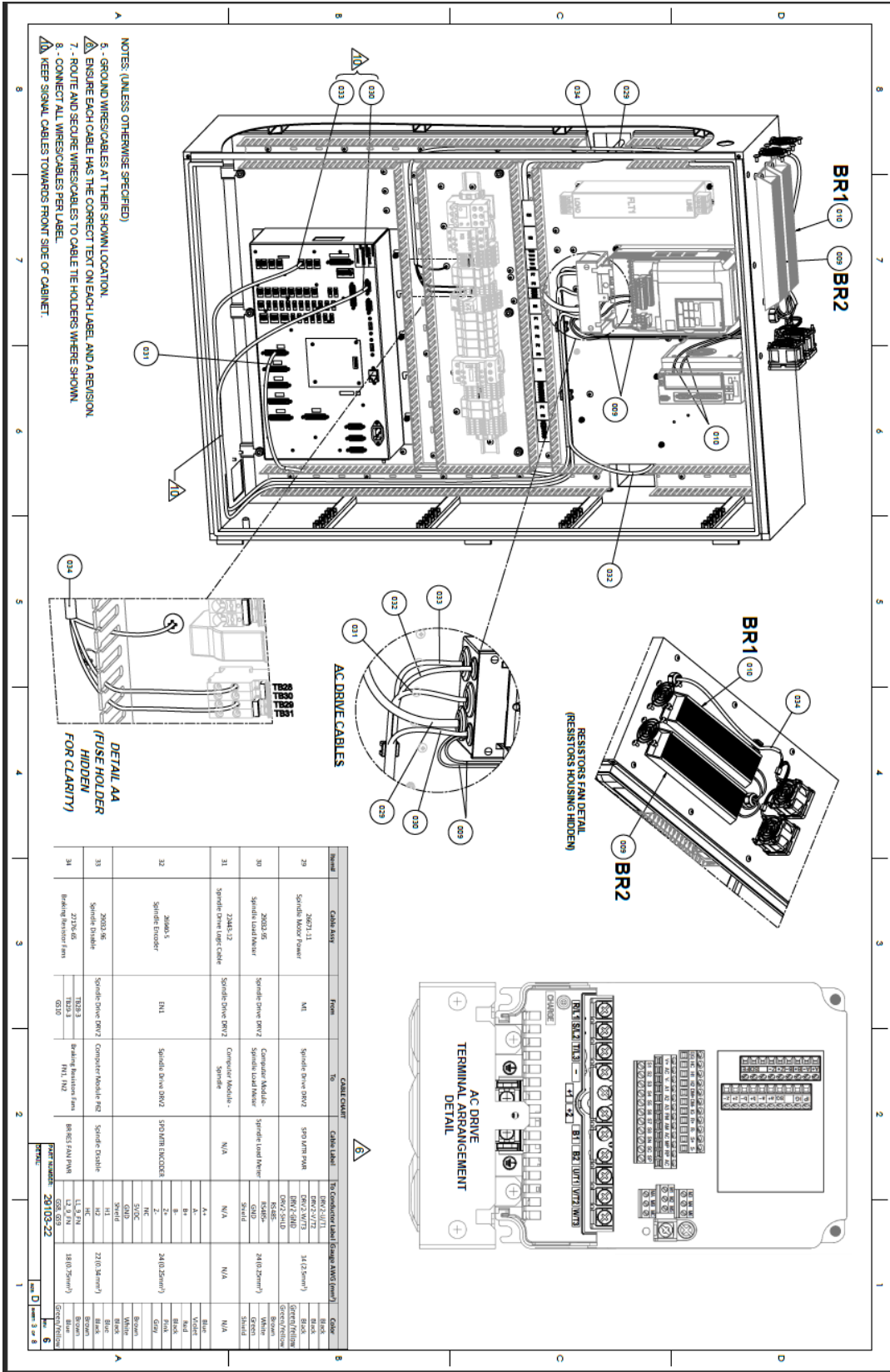

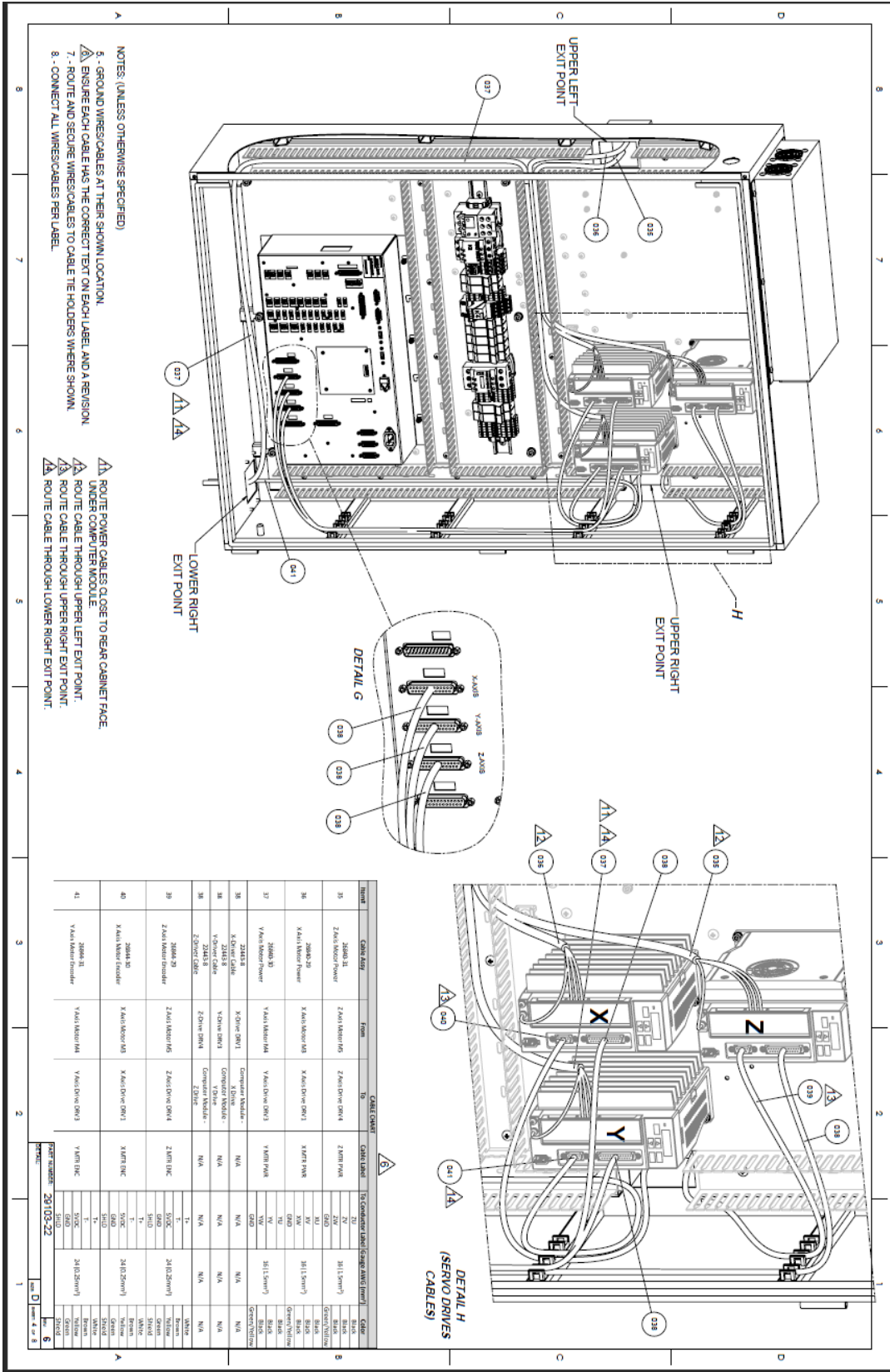

- NOTES: (UNLESS OTHERWISE SPECIFIED)
- 5. GROUND WIRES/CABLES AT THEIR SHOWN LOCATION.
 - 6. ROUTE EACH CABLE HAS THE CORRECT TEXT ON EACH LABEL AND A REVISION.
 - 7. ROUTE AND SECURE WIRES/CABLES TO CABLE TIE HOLDERS WHERE SHOWN.
 - 8. CONNECT ALL WIRES/CABLES PER LABEL.

- △△ ROUTE POWER CABLES CLOSE TO REAR CABINET FACE UNDER COMPUTER MODULE.
- △△ ROUTE CABLE THROUGH UPPER LEFT EXIT POINT.
- △△ ROUTE CABLE THROUGH UPPER RIGHT EXIT POINT.
- △△ ROUTE CABLE THROUGH LOWER RIGHT EXIT POINT.

ITEM#	CABLE NAME	FROM	TO	CABLE LABEL	TO COMPONENT LABEL (CHANGE NAME IF NEEDED)	CODE
35	Z0000 21	Z 000 Motor PG	Z 000 Drive DM04	Z 000 PWR	BE11 (S000*)	BE11
36	Z0000 20	X 000 Motor PG	X 000 Drive DM03	X 000 PWR	BE11 (S000*)	BE11
37	Z0000 20	Y 000 Motor PG	Y 000 Drive DM03	Y 000 PWR	BE11 (S000*)	BE11
38	Z0000 20	V 000 Motor PG	V 000 Drive DM03	V 000 PWR	BE11 (S000*)	BE11
39	Z0000 20	W 000 Motor PG	W 000 Drive DM03	W 000 PWR	BE11 (S000*)	BE11
40	Z0000 20	Z 000 Motor PG	Z 000 Drive DM04	Z 000 PWR	BE11 (S000*)	BE11
41	Z0000 20	X 000 Motor PG	X 000 Drive DM03	X 000 PWR	BE11 (S000*)	BE11

ITEM#	DESCRIPTION	QTY	UNIT	REV	DATE	BY	CHKD
1	Wiring Diagram	1	Sheet	1	10/10/22	J. Smith	J. Smith
2	Parts List	1	Sheet	1	10/10/22	J. Smith	J. Smith
3	Assembly Instructions	1	Sheet	1	10/10/22	J. Smith	J. Smith
4	Test Procedures	1	Sheet	1	10/10/22	J. Smith	J. Smith
5	Maintenance Schedule	1	Sheet	1	10/10/22	J. Smith	J. Smith
6	Warranty Card	1	Sheet	1	10/10/22	J. Smith	J. Smith

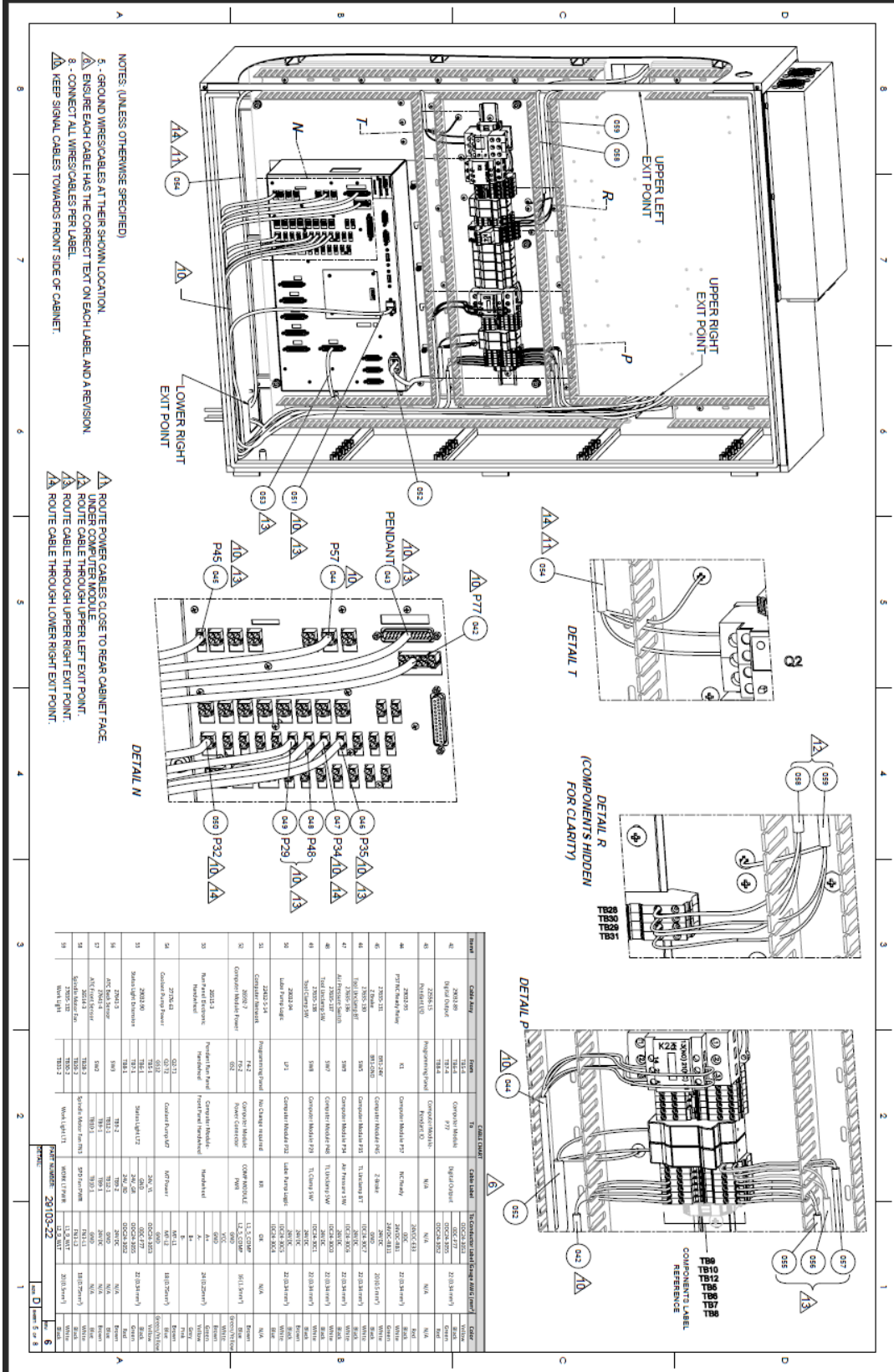

NOTES: (UNLESS OTHERWISE SPECIFIED)
 5. - GROUND WIRES/CABLES AT THEIR SHOWN LOCATION.
 6. - ENSURE EACH CABLE HAS THE CORRECT TEXT ON EACH LABEL AND A REVISION.
 7. - CONNECT ALL WIRES/CABLES PER LABEL.
 8. - KEEP SIGNAL CABLES TOWARDS FRONT SIDE OF CABINET.

△ ROUTE POWER CABLES CLOSE TO REAR CABINET FACE.
 △ UNDER COMPUTERS THROUGH
 △ ROUTE CABLE THROUGH UPPER LEFT EXIT POINT.
 △ ROUTE CABLE THROUGH UPPER RIGHT EXIT POINT.
 △ ROUTE CABLE THROUGH LOWER RIGHT EXIT POINT.

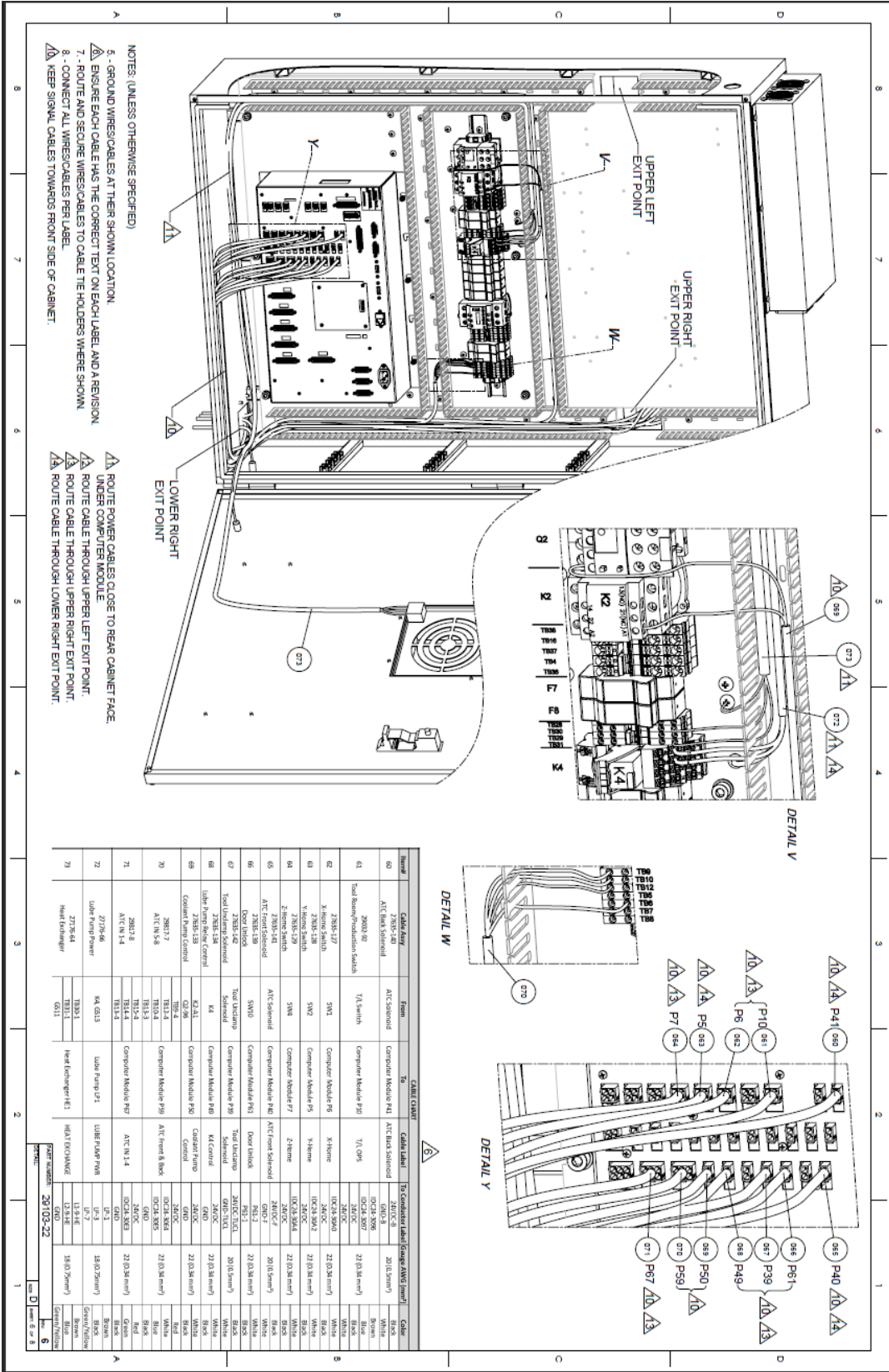

PART NUMBER:		DRAWN BY: NG 5/11/2020							
29103-22		ENGINEER: SK 5/11/2020							
Item No.	Part Number	Description	Detail	Type	QTY.	Who	Category	MFG Part Number	Manufacturer
001	29145-22	ENCLOSURE ASSY-VMC2		Normal	1		Purchased	TBD (KR)	King Rich
002	29125-22	PANEL BACK ASSY-VMC2		Normal	1		Purchased	TBD (KR)	King Rich
003	29100-1	COMPUTER MODULE ASSY-VMC		Reference	1		Manufactured		
004	29103-22-UB1	LABEL TEXT-VMC2-MAIN		Normal	1		Purchased		
005	29013-4	SHEET METAL-ELEC CABINET SWITCH MOUNT		Normal	1		Purchased	TBD (PING JENG)	Ping Jeng
006	24394-8	CIRCUIT BREAKER-220V/30A		Normal	1		Purchased	BW05AG-3P032	Fuji
007	22953	HANDLE OPERATING MECHANISM		Normal	1		Purchased	B2N10D	Fuji
008	22955-3	COVER/BREAKER-LONG		Normal	2		Purchased	BW05TAA-L3W	Fuji
009	27175-3	RESISTOR ASSY-30 OHM-400W-BRAKE Z AXIS		Normal	1		Purchased		
010	22960-500-16-1	RESISTOR-BRAKING-16 OHM-500W		Normal	1		Purchased		
011	23166-1	FITTING - LIQUID TIGHT STRAIGHT STRAIN RELIEF M20X1.5		Normal	2		Purchased	CD20MR-BK	Season
012	31817	SHEET METAL-BRAKING RESISTOR-ENCLOSURE		Normal	1		Purchased	TBD (KR)	King Rich
013	31821	FAN GUARD-80 MM		Normal	4		Purchased	09-147	Quitek
014	31823	FAN-80 X 80 X 30MM		Normal	2		Purchased	GA40030	Gulf
015	31822	FILTER GUARD-PLASTIC		Normal	2		Purchased	D-08	Gulf
016	MA-0-7X50 (12Z)	SCREW-FH-PHIL-STL-ZINC		Normal	8		Purchased		
017	MA-0-7 (60Z)	NUT-FHX-STL-ZINC		Normal	8		Purchased		
018	MA-0-8X10 (22Z)	SCREW-TH-PHIL-STL-ZINC		Normal	22		Purchased		
019	MA-0-8X10 (25B)	SCREW-SHCS-STL-80		Normal	6		Purchased		
020	24008-4	WASHER-BELLEVILLE SPRING UK-SERRATED	208 ID X .394 OD X .0212 THK-10 OR M6	Normal	6		Purchased		
021	MA (79B)	WASHER-FLAT USS-STL-80		Normal	6		Purchased		
022	MA-1-26X12 (25B)	SCREW-SHCS-STL-80		Normal	9		Purchased	WSPFST1029N051PFLD 31S	ATLAS BOLT
023	24008-1	WASHER-BELLEVILLE SPRING UK-SERRATED	331 ID X .512 OD X .028 THK-5/16 OR M8	Normal	9		Purchased		
024	MA (79B)	WASHER-FLAT USS-STL-80		Normal	9		Purchased		
025	MA-1.0X16 (25B)	SCREW-SHCS-STL-80		Normal	4		Purchased		
026	24008-3	WASHER-BELLEVILLE SPRING UK-SERRATED	294 ID X .374 OD X .024 THK-1/4 OR M6	Normal	4		Purchased	WSPFST1029N037FLD 25S	ATLAS BOLT
027	MA (79B)	WASHER-FLAT USS-STL-80		Normal	4		Purchased		
028	21490-5	POWER CORD ASSY-3 PHASE 220V 20P		Normal	1		Purchased		
029	29071-11	CABLE ASSY-SPINDLE MOTOR PMR		Normal	2		Purchased		
030	29033-95	CABLE ASSY-SPINDLE LOAD METER-EXTERNAL		Normal	1		Purchased		
031	22445-12	CABLE ASSY-AC DRIVE TO COMPUTER-VMC		Normal	1		Manufactured		
032	29940-5	CABLE ASSY-SPINDLE MOTOR ENCODER		Normal	1		Purchased		
033	29032-06	CABLE ASSY-4 COND-P92-SPINDLE DISABLE		Normal	1		Purchased		
034	27176-85	CABLE ASSY-3 RESISTOR FANS POWER		Normal	1		Purchased		
035	29940-31	CABLE ASSY-MOTOR POWER-DELTA Z AXIS		Normal	1		Purchased	TBD (KR)	King Rich
036	29940-29	CABLE ASSY-HIGH FLEX-MOTOR POWER-DELTA X AXIS		Normal	1		Purchased	TBD (KR)	King Rich
037	29940-30	CABLE ASSY-MOTOR POWER-DELTA Y AXIS		Normal	1		Purchased	TBD (KR)	King Rich
038	22443-8	CABLE ASSY-DELTA DRIVE TO RX COMPUTER		Normal	3		Manufactured		

PRODUCTS USED ON:

REV: 6 SHEET: 7 OF 8

Item No.	Part Number	Description	Detail	Type	QTY.	Who	Category	MFG Part Number	Manufacturer
039	28944-29	CABLE ASSY-MOTOR ENCODER-Z-AXIS		Normal	1		Purchased	TBD (KR)	King Rich
040	28944-30	CABLE ASSY-MOTOR ENCODER-X-AXIS		Normal	1		Purchased	TBD (KR)	King Rich
041	28944-31	CABLE ASSY-MOTOR ENCODER-Y-AXIS		Normal	1		Purchased	TBD (KR)	King Rich
042	28032-89	CABLE ASSY-4 COND P77 STATUS LIGHT		Normal	1		Purchased		
043	22566-15	CABLE ASSY-25 PIN/ALE/FEMALE DB CONNECTOR-19FT		Normal	1		Purchased	CSMM25MF-15	L-COM
044	28032-93	CABLE ASSY-4 COND/P57-NC READY TO K1		Normal	1		Purchased		
045	27035-131	CABLE ASSY-Z-AXIS BRAKE		Normal	1		Purchased		
046	27035-130	CABLE ASSY-2 COND/TOOL UNCLAMP BUTTON		Normal	1		Purchased	TBD (KR)	King Rich
047	27035-138	CABLE ASSY-LIMIT SW-AIR PRESSURE		Normal	1		Purchased		
048	27035-137	CABLE ASSY-LIMIT SW-TOOL UNCLAMP		Normal	1		Purchased		
049	27035-138	CABLE ASSY-LIMIT SW-TOOL CLAMP		Normal	1		Purchased		
050	28032-94	CABLE ASSY-4 COND-P32-LUBE PUMP LOGIC		Normal	1		Purchased		
051	22432-5-14	CABLE ASSY-R45-NETWORK-CAT5E		Normal	1		Purchased	TRD015BLK-14	L-COM
052	28662-7	CABLE ASSY-3 CONDCOMPUTER MODULE PWR		Normal	1		Purchased	TBD (KR)	King Rich
053	28615-3	CABLE ASSY-HANDWHEEL TO MOTION MODULE-VMC		Normal	1		Purchased	TBD (KR)	King Rich
054	27178-93	CABLE ASSY-COOLANT PUMP		Normal	1		Purchased		
055	28032-90	CABLE ASSY-4 COND STATUS LIGHT EXTENSION		Normal	1		Purchased		
056	27041-5	SENSOR ASSY-ATC BACK INPUT		Normal	1		Purchased		
057	27041-4	SENSOR ASSY-ATC FRONT INPUT		Normal	1		Purchased		
058	28614-3	CABLE ASSY-SPINDLE MOTOR FAN		Normal	1		Purchased		
059	27035-132	CABLE ASSY-SPINDLE MOTOR FAN		Normal	1		Purchased		
060	27035-140	CABLE ASSY-SOLENOID ATC BACK		Normal	1		Purchased		
061	28032-82	CABLE ASSY-4 COND-TIP MODE		Normal	1		Purchased	TBD (KR)	King Rich
062	27035-127	CABLE ASSY-2 COND-P6-X-HOME SWITCH		Normal	1		Purchased	TBD (KR)	King Rich
063	27035-128	CABLE ASSY-2 COND-P5-Y-HOME SWITCH		Normal	1		Purchased	TBD (KR)	King Rich
064	27035-129	CABLE ASSY-2 COND-P7-Z-HOME SWITCH		Normal	1		Purchased	TBD (KR)	King Rich
065	27035-141	CABLE ASSY-SOLENOID ATC FRONT		Normal	1		Purchased		
066	27035-139	CABLE ASSY-DOOR GUARD		Normal	1		Purchased		
067	27035-142	CABLE ASSY-SOLENOID TOOL UNCLAMP		Normal	1		Purchased		
068	27035-134	CABLE ASSY-2 COND/LUBE PUMP-COMP TO K4		Normal	1		Purchased		
069	27035-133	CABLE ASSY-2 COND/COOL PUMP RELAY-COMP TO K5		Normal	1		Purchased		
070	28817-7	CABLE ASSY-4 COND/P56-ATC INPUTS		Normal	1		Purchased		
071	28817-8	CABLE ASSY-3 COND/P7-ATC INPUTS		Normal	1		Purchased		
072	27178-86	CABLE ASSY-3 COND/LUBE PUMP-POWER		Normal	1		Purchased		
073	27178-84	CABLE ASSY-3 COND/HEAT EXCHANGE		Normal	1		Purchased		

PRODUCTS USED ON:

REV: 6 SHEET: 8 OF 8

TRAK Machine Tools
Southwestern Industries, Inc

TRAK Warranty Policy

Warranty

TRAK products are warranted to the original purchaser to be free from defects in workmanship and materials for the following periods:

Product	Warranty Period	
	Materials	Factory Labor
New TRAK/ProtoTRAK	1 Year	1 Year
Any EXCHANGE Unit	90 Days	90 Days

The warranty period starts on the date of the invoice to the original purchaser from Southwestern Industries, Inc. (SWI) or their authorized distributor.

If a product, subsystem or component proves to be defective in workmanship and fails within the warranty period, it will be repaired or exchanged at our option for a properly functioning unit in similar or better condition. Such repairs or exchanges will be made FOB Factory/Los Angeles or the location of our nearest factory representative or authorized distributor.

Warranty Disclaimers

- This warranty is expressly in lieu of any other warranties, express or implied, including any implied warranty of merchantability or fitness for a particular purpose, and of any other obligations or liability on the part of SWI (or any producing entity, if different).
- Warranty repairs/exchanges do not cover incidental costs such as installation, labor, freight, etc.
- SWI is not responsible for consequential damages from use or misuse of any of its products.
- TRAK products are precision mechanical/electromechanical/electronic systems and must be given the reasonable care that these types of products require. Evidence that the product does not receive adequate Preventative Maintenance may invalidate the warranty. Excessive chips built up around ballscrews and way surfaces is an example of this evidence.
- Accidental damage, beyond the control of SWI, is not covered by the warranty. Thus, the warranty does not apply if a product has been abused, dropped, hit or disassembled.
- Improper installation by or at the direction of the customer in such a way that the product consequently fails, is considered to be beyond the control of the manufacturer and outside the scope of the warranty.
- Warranty does not cover wear items that are consumed under normal use of the product. These items include, but are not limited to: windows, bellows, wipers, filters, drawbars and belts.

F10302 | Rev: 020620